

Miniature resistance thermometer

For sanitary applications, for orbital welding

Model TR21-B

WIKA data sheet TE 60.27



for further approvals
see page 5

Applications

- Sanitary applications
- Food and beverage industry
- Bio and pharmaceutical industry, production of active ingredients

Special features

- Sensor can be calibrated without having to open the process
- Simple and fast electrical connection using an M12 x 1 plug connection
- With direct sensor output (Pt100/Pt1000 in 3 or 4-wire version) or integrated transmitter with 4 ... 20 mA output signal, individually parameterisable with free-of-charge WIKAsoft-TT PC configuration software
- Wetted parts from stainless steel 1.4435
- Self-draining and dead-space minimised, materials and surface finish qualities in accordance with standards of hygienic design

Description

The model TR21-B resistance thermometer provides temperature measurement in sanitary applications and can be used for the measurement of liquid and gaseous media in the range of -30 ... +150 °C [-22 ... +302 °F]. For use in hazardous areas, intrinsically safe versions are available.

The connection ends are smooth and prepared for orbital welding. The process connections meet the stringent requirements, in terms of materials and design, of hygienic measuring points. All electrical components are protected against moisture (IP67 or IP69K).

The resistance thermometer is available with direct sensor output or integrated transmitter, which can be configured individually via the WIKAsoft-TT PC configuration software. Measuring range, dampening, error signalling per NAMUR NE 043 and TAG no. can be adjusted.



Model TR21-B with flow-through housing

For easy calibration or maintenance, the sensor is interchangeable without having to open the process. Thus hygiene risks can be minimised and downtimes can be reduced.

The spring loading, integrated into the union nut, guarantees the contact between the sensor tip and the bottom of the protection tube and thus ensures a short response time and lasting high accuracy. Insertion length, process connection, sensor and connection method can each be selected for the respective application within the ordering information. The electrical connection is made via an M12 x 1 circular connector.

For applications requiring the sterilisation of the instrument in autoclaves, an especially temperature-resistant instrument version is available.

Specifications

Measuring element	
Type of measuring element	
4 ... 20 mA version (models TR21-B-xTT, TR21-B-xTB)	<ul style="list-style-type: none"> ■ Pt1000 (measuring current < 0.3 mA; self-heating can be ignored) ■ Face-sensitive Pt1000 ¹⁾ (measuring current < 0.3 mA; self-heating can be ignored)
Pt100 (model TR21-B-xPx)/Pt1000 (model TR21-B-xRx) version	<ul style="list-style-type: none"> ■ Pt100 (measuring current: 0.1 ... 1.0 mA) ■ Face-sensitive Pt100 (measuring current 0.1 ... 1.0 mA) ¹⁾ ■ Pt1000 (measuring current: 0.1 ... 0.3 mA) ■ Face-sensitive Pt1000 (measuring current 0.1 ... 0.3 mA) ¹⁾
→ For detailed specifications for Pt sensors, see Technical information IN 00.17 at www.wika.com .	
Connection method	
4 ... 20 mA version (models TR21-B-xTT, TR21-B-xTB)	2-wire
Pt100 (model TR21-B-xPx)/Pt1000 (model TR21-B-xRx) version	3-wire With a cable length of 30 m or longer, measuring deviations can occur
	4-wire The lead resistance can be ignored
Tolerance value of the measuring element ²⁾ per IEC 60751	
4 ... 20 mA version (models TR21-B-xTT, TR21-B-xTB)	Class A
Pt100 (model TR21-B-xPx)/Pt1000 (model TR21-B-xRx) version	<ul style="list-style-type: none"> ■ Class AA ³⁾ ■ Class A

- 1) Face-sensitive measuring resistors, through their small design they serve to reduce the heat dissipation with short insertion lengths. Available for the temperature range up to 150 °C [302 °F]. For protection tube insertion lengths of less than 50 mm, face-sensitive measuring resistors are recommended. For protection tube insertion lengths of less than 11 mm, face-sensitive measuring resistors are generally used.
- 2) Depending on the process connection, the deviation can be greater.
- 3) Class accuracy AA only valid in the temperature range 0 ... 150 °C [32 ... 302 °F]

Accuracy specifications (4 ... 20 mA version)	
Tolerance value of the measuring element ²⁾ per IEC 60751	Class A
Measuring deviation of the transmitter per IEC 62828	±0.25 K
Total measuring deviation in accordance with IEC 62828	Measuring deviation of the measuring element + transmitter
Influence of the ambient temperature	0.1 % of span / 10 K T _a
Influence of supply voltage	±0.025 % / V (depending on the supply voltage U _B)
Influence of the load	±0.05 % / 100 Ω
Linearisation	Linear to temperature per IEC 60751
Linearisation error	±0.1 % ¹⁾ of the set measuring span
Reference conditions	
Ambient temperature T _a ref	23 °C
Supply voltage U _B ref	DC 12 V

- 1) ±0.2 % for start of measuring range less than 0 °C [32 °F]
- 2) Depending on the process connection, the deviation can be greater.

Example calculation: Total measuring deviation

(measuring range 0 ... 150 °C, load 200 Ω, supply voltage 16 V, ambient temperature 33 °C, process temperature 100 °C)

Sensor element (class A per IEC 60751: 0.15+ (0.0020(t))):	±0.350 K
Measuring deviation of the transmitter ±0.25 K:	±0.250 K
Output error ±(0.1 % of 150 K):	±0.150 K
Effect of load ±(0.05 % / 100 Ω of 150 K):	±0.150 K
Influence of supply voltage ±(0.025 % / V of 150 K):	±0.150 K
Influence of the ambient temperature ±(0.1 % / 10 K T _a of 150 K):	±0.150 K

Measuring deviation (typical)

$$\sqrt{0.35 K^2 + 0.25 K^2 + 0.15 K^2 + 0.15 K^2 + 0.15 K^2}$$

$$\sqrt{0.275 K^2} = 0.524 K$$

Measuring deviation (maximum)

$$0.35 K + 0.25 K + 0.15 K + 0.15 K + 0.15 K + 0.15 K = 1.2 K$$

Measuring range	
Temperature range	
4 ... 20 mA version (models TR21-B-xTT, TR21-B-xTB)	-30 ... +150 °C [-22 ... +302 °F] ¹⁾
Pt100 (model TR21-B-xPx)/ Pt1000 (model TR21-B-xRx) version	Class AA 0 ... 150 °C [32 ... 302 °F]
	Class A -30 ... +150 °C [-22 ... +302 °F]
Unit (4 ... 20 mA version)	Configurable °C, °F, K
Temperature at the connector (Pt100, Pt1000 version)	Max. 85 °C [185 °F]
Measuring span (4 ... 20 mA version)	Minimum 20 K, maximum 300 K

1) The temperature transmitter should therefore be protected from temperatures over 85 °C [185 °F].

Process connection	
Type of process connection	<ul style="list-style-type: none"> ■ Flow-through housing ■ Angular housing
Protection tube	
Protection tube model	TW61
Protection tube design	→ see drawings from page 10
Surface roughness	Per DIN 11866 row A, B <ul style="list-style-type: none"> ■ $R_a < 0.8 \mu\text{m}$ ■ $R_a < 0.4 \mu\text{m}$ electropolished
	Per DIN 11866 row C, ASME-BPE <ul style="list-style-type: none"> ■ $R_a < 0.76 \mu\text{m}$ ■ $R_a < 0.38 \mu\text{m}$ electropolished
Connection to thermometer	G 3/8"
Material (wetted)	Per DIN 11866 row A, B Stainless steel 1.4435
	Per DIN 11866 row C, ASME-BPE Stainless steel 316L

→ For dimensions, see dimension tables from page 10

Output signal (4 ... 20 mA version)	
Analogue output	4 ... 20 mA, 2-wire
Load R_A	$R_A \leq (U_B - 10 \text{ V}) / 23 \text{ mA}$ with R_A in Ω and U_B in V The permissible load depends on the loop supply voltage. For communication with the instrument with programming unit PU-548, a max. load of 350 Ω is admissible.
Load diagram	

Output signal (4 ... 20 mA version)

Factory configuration

Measuring range	Measuring range 0 ... 150 °C [32 ... 302 °F] Other measuring ranges are adjustable
Current signals for error signalling	Configurable in accordance with NAMUR NE 043 downscale ≤ 3.6 mA upscale ≥ 21.0 mA
Current value for sensor short-circuit	Not configurable in accordance with NAMUR NE 043 downscale ≤ 3.6 mA

Communication

Info data	TAG no., description and user message can be stored in transmitter
Configuration and calibration data	Permanently stored
Configuration software	WIKAsoft-TT → Configuration software (multilingual) as a download from www.wika.com

Voltage supply

Supply voltage U_B	DC 10 ... 30 V
Supply voltage input	Protected against reverse polarity
Permissible residual ripple of supply voltage	10 % generated by $U_B < 3$ % ripple of the output current

Time response

Switch-on delay, electrical	Max. 4 s (time before the first measured value)
Warm-up time	After approx. 4 minutes, the instrument will function to the specifications (accuracy) given in the data sheet.
Response time (per IEC 60751)	$t_{50} < 3.2$ s $t_{90} < 7.3$ s

Electrical connection

Connection type	M12 x 1 circular connector (4-pin)
Material	Stainless steel 1.4404

Pin assignment

Output signal 4 ... 20 mA
M12 x 1 circular connector (4-pin)

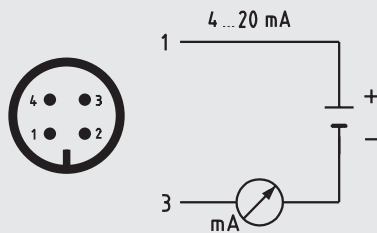

Pin	Signal	Description
1	L+	10 ... 30 V
2	VQ	not connected
3	L-	0 V
4	C	not connected

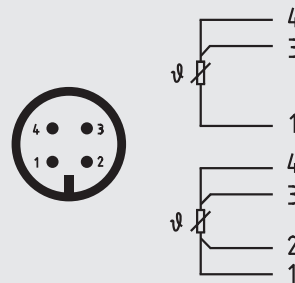

Output signal Pt100 sensor
M12 x 1 circular connector (4-pin)













Operating conditions	
Ambient temperature range	
4 ... 20 mA version (models TR21-B-xTT, TR21-B-xTB)	-40 ... +85 °C [-40 ... +185 °F]
Pt100 (model TR21-B-xPx)/Pt1000 (model TR21-B-xRx) version	-50 ... +85 °C [-58 ... +185 °F]
	-40 ... +85 °C [-40 ... +185 °F]
Climate class per IEC 60654-1	
4 ... 20 mA version (models TR21-B-xTT, TR21-B-xTB)	Cx (-40 ... +85 °C [-40 ... +185 °F], 5 ... 95 % r. h.)
Pt100 (model TR21-B-xPx)/Pt1000 (model TR21-B-xRx) version	Cx (-50 ... +85 °C [-58 ... +185 °F], 5 ... 95 % r. h.)
	100 % r. h., condensation allowed
Max. operating pressure	Dependent on particular process connection
Salt fog	IEC 60068-2-11
Shock resistance per IEC 60068-2-27	50 g, 6 ms, 3 axes, 3 directions, three times per direction
Maximum permissible autoclaving conditions	Max. 134 °C, 3 bar abs., 100 % r. h., duration 20 min., max. 50 cycles Autoclavable with mounted protective cap at coupler connector
Conditions for outdoor use (only applies to UL approval)	<ul style="list-style-type: none"> ■ The instrument is suitable for applications with pollution degree 3. ■ The power supply must be suitable for operation above 2,000 m should the temperature transmitter be used at this altitude. ■ The instrument shall be installed in locations sheltered from the weather. ■ The instrument shall be installed sun/UV irradiation protected.
Ingress protection (IP code)	
Case with connected connector ¹⁾	<ul style="list-style-type: none"> ■ IP67 per IEC/EN 60529 ■ IP69 per IEC/EN 60529 ■ IP69K per ISO 20653 <p>The stated ingress protection only applies when plugged in using line connectors that have the appropriate ingress protection.</p>
Coupler connector, not connected	IP67 per IEC/EN 60529
Weight in kg	approx. 0.3 ... 2.5 (depending on version)





1) Not tested with UL

Approvals

Logo	Description	Region
	EU declaration of conformity	European Union
	EMC directive ^{1) 2)} EN 61326 emission (group 1, class B) and immunity (industrial application)	
	Pressure equipment directive For thermowells/protection tubes > DN 25 (1") and for the associated marking on the measuring instrument or thermowell/protection tube, WIKA confirms conformity with the pressure equipment directive in accordance with the conformity assessment procedure, module H. For thermowells/protection tubes with nominal widths of ≤ DN 25 (1"), a CE marking in accordance with the pressure equipment directive (PED) is not permitted and therefore, they are designed and manufactured without CE marking in line with the applicable sound engineering practice.	
	RoHS directive	
	UL - only for instrument version without explosion protection Safety (e.g. electr. safety, overpressure, ...)	USA and Canada

Optional approvals

Logo	Description	Region
 	EU declaration of conformity ATEX directive Hazardous areas Zone 0 gas II 1G Ex ia IIC T1 ... T6 Ga Zone 1 mounting to zone 0 gas II 1/2G Ex ia IIC T1 ... T6 Ga/Gb Zone 1 gas II 2G Ex ia IIC T1 ... T6 Gb Zone 20 dust II 1D Ex ia IIIC T135 °C Da Zone 21 mounting to zone 20 dust II 1/2D Ex ia IIIC T135 °C Da/Db Zone 21 dust II 2D Ex ia IIIC T135 °C Db	European Union
 	IECEx - in combination with ATEX Hazardous areas Zone 0 gas Ex ia IIC T1 ... T6 Ga Zone 1 mounting to zone 0 gas Ex ia IIC T1 ... T6 Ga/Gb Zone 1 gas Ex ia IIC T1 ... T6 Gb Zone 20 dust Ex ia IIIC T135 °C Da Zone 21 mounting to zone 20 dust Ex ia IIIC T135 °C Da/Db Zone 21 dust Ex ia IIIC T135 °C Db	International
	CSA Safety (e.g. electr. safety, overpressure, ...) Hazardous areas Class I, division 1 or 2, groups A, B, C, D T1 ... T6 Class I, zone 0 or 1, IIC Ex/AEx ia IIC T1 ... T6 Ga Class II / III, division 1 or 2, groups E, F, G T1 ... T6 / 135 °C Class II / III, zone 20 or 21, Ex/AEx ia IIIC T135 °C Da	USA and Canada
	EAC EMC directive ¹⁾	Eurasian Economic Community
	Hazardous areas Zone 0 gas 0Ex ia IIC T6 ... T1 Ga X Zone 1 gas 1Ex ia IIC T6 ... T1 Gb X Zone 1 gas Ex ia IIIC T135 °C Gb X Zone 1 mounting to zone 0 gas Ex ia IIC T6 ... T1 Ga/Gb X Zone 20 dust Ex ia IIIC T135 °C Da X Zone 20 dust Ex ia IIIC T80 ... T440 Da X Zone 21 dust Ex ia IIIC T80 ... T440 Db X	
	Ex Ukraine Hazardous areas Zone 0 gas II 1G Ex ia IIC T6 ... T1 Ga Zone 20 dust II 1D Ex ia IIIC T135 °C Da Zone 1 mounting to zone 0 gas II 1/2G Ex ia IIC T6 ... T1 Ga/Gb Zone 21 mounting to zone 20 dust II 1/2D Ex ia IIIC T135 °C Da/Db Zone 1 gas II 2G Ex ia IIC T6 ... T1 Gb Zone 21 dust II 2D Ex ia IIIC T135 °C Db Zone 1 gas II 2G Ex ib IIC T6 ... T1 Gb Zone 21 dust II 2D Ex ib IIIC T135 °C Db Zone 1 mounting to zone 0 gas II 1/2G Ex ib IIC T6 ... T1 Ga/Gb Zone 21 mounting to zone 20 dust II 1/2D Ex ib IIIC T135 °C Da/Db	Ukraine
	CCC ³⁾ Hazardous areas Zone 0 gas Ex ia IIC T1~T6 Ga Zone 1 gas Ex ia IIC T1~T6 Gb Zone 1 mounting to zone 0 gas Ex ia IIC T1~T6 Ga/Gb Zone 20 dust Ex iaD 20 T135 Zone 21 dust Ex iaD 21 T135 Zone 21 mounting to zone 20 dust Ex iaD 20/21 T135	China
	PAC Russia Metrology, measurement technology	Russia
	PAC Kazakhstan Metrology, measurement technology	Kazakhstan

Logo	Description	Region
-	MChS Permission for commissioning	Kazakhstan
	PAC Belarus Metrology, measurement technology	Belarus
	PAC Uzbekistan Metrology, measurement technology	Uzbekistan
	3-A ⁴⁾ Hygienic Design	USA
	EHEDG ⁴⁾ Hygienic Design	European Union

- 1) Only for built-in transmitter
2) During transient interferences (e.g. burst, surge, ESD) take into account an increased measuring deviation of up to 2 %.
3) Not for built-in transmitter
4) Confirmation of 3-A or EHEDG conformity only valid with separately selectable 2.2 test report

Instruments marked with "ia" may also be used in areas only requiring instruments marked with "ib" or "ic".
If an instrument with "ia" marking has been used in an area with requirements in accordance with "ib" or "ic", it can no longer be operated in areas with requirements in accordance with "ia" afterwards.

Certificates (option)

Certificates		
Certificates	<ul style="list-style-type: none"> ■ 2.2 test report ■ 3.1 inspection certificate ■ DAkkS calibration certificate ■ Manufacturer's declaration regarding regulation (EC) 1935/2004 and (EC) 2023/2006 ■ Certificate of the surface roughness of wetted parts 	
Hygienic certificates	3-A approval	EHEDG approval
Flow-through housing	For all dimensions	For all dimensions
Angular housing	DIN 11866 row A: DN 32 ... 100 DIN 11866 row B: DN 25 ... 80 DIN 11866 row C: DN 1 ½" ... 4"	DIN 11866 row A: DN 32 ... 100 DIN 11866 row B: DN 25 ... 80 DIN 11866 row C: DN 1 ½" ... 4"

For calibration, the measuring insert is removed from the thermometer. The minimum length (metal part of the probe) for carrying out a measurement accuracy test 3.1 or DAkkS is 100 mm [3.94 in].

Calibration of shorter lengths on request.

→ Approvals and certificates, see website

Patents, property rights

Patent number	Description
DE 102010037994 US 12 897.080	Dead-space free welding nipple for protection tube model TW61

Safety-relevant characteristic values for explosion-protected version (option)

Thermometer with transmitter and 4 ... 20 mA output signal (models TR21-B-xTT, TR21-B-xTB)

Marking:

Hazardous gas atmosphere	Temperature class	Ambient temperature range (T_a)	Maximum surface temperature (T_{max}) at the tip of the probe or protection tube
II 1G Ex ia IIC T1 - T6 Ga II 1/2G Ex ia IIC T1 - T6 Ga/Gb II 2G Ex ia IIC T1 - T6 Gb	T6	-40 ... +45 °C	T_M (medium temperature) + self-heating (15 K) Pay attention to the special conditions for safe use.
	T5	-40 ... +60 °C	
	T4	-40 ... +85 °C	
	T3	-40 ... +85 °C	
	T2	-40 ... +85 °C	
	T1	-40 ... +85 °C	

Hazardous dust atmosphere	Power P_i	Ambient temperature range (T_a)	Maximum surface temperature (T_{max}) at the tip of the probe or protection tube
II 1D Ex ia IIIC T135 °C Da II 1/2D Ex ia IIIC T135 °C Da/Db II 2D Ex ia IIIC T135 °C Db	750 mW	-40 ... +40 °C	T_M (medium temperature) + self-heating (15 K) Pay attention to the special conditions for safe use.
	650 mW	-40 ... +70 °C	
	550 mW	-40 ... +85 °C	

Safety-related maximum values for the current loop circuit (+ and - connections):

Parameters	Hazardous gas atmosphere	Hazardous dust atmosphere
Terminals	+ / -	+ / -
Voltage U_i	DC 30 V	DC 30 V
Current I_i	120 mA	120 mA
Power P_i	800 mW	750/650/550 mW
Effective internal capacitance C_i	29.7 nF	29.7 nF
Effective internal inductance L_i	Negligible	Negligible
Maximum self-heating at the probe or protection tube tip	15 K	15 K

Thermometer with direct sensor output with Pt100 (model TR21-B-xPx) or Pt1000 (model TR21-B-xRx)

Marking:

Marking	Temperature class	Ambient temperature range (T_a)	Maximum surface temperature (T_{max}) at the tip of the probe or protection tube
II 1G Ex ia IIC T1 - T6 Ga II 1/2G Ex ia IIC T1 - T6 Ga/Gb II 2G Ex ia IIC T1 - T6 Gb	T6	-50 ... +80 °C	T_M (medium temperature) + self-heating Pay attention to the special conditions for safe use.
	T5	-50 ... +85 °C	
	T4	-50 ... +85 °C	
	T3	-50 ... +85 °C	
	T2	-50 ... +85 °C	
	T1	-50 ... +85 °C	

Marking	Power P_i	Ambient temperature range (T_a)	Maximum surface temperature (T_{max}) at the tip of the probe or protection tube
II 1D Ex ia IIIC T135 °C Da II 1/2D Ex ia IIIC T135 °C Da/Db II 2D Ex ia IIIC T135 °C Db	750 mW	-50 ... +40 °C	T_M (medium temperature) + self-heating Pay attention to the special conditions for safe use.
	650 mW	-50 ... +70 °C	
	550 mW	-50 ... +85 °C	

Safety-related maximum values for the current loop circuit (connections in accordance with pin assignment 1 - 4):

Parameters	Gas applications	Dust applications
Terminals	1 - 4	1 - 4
Voltage U_i	DC 30 V	DC 30 V
Current I_i	550 mA	250 mA
Power P_i	1,500 mW	750/650/550 mW
Effective internal capacitance C_i	Negligible	Negligible
Effective internal inductance L_i	Negligible	Negligible
Maximum self-heating at the probe or protection tube tip	$(R_{th}) = 335 \text{ K/W}$	$(R_{th}) = 335 \text{ K/W}$

Overview of the process connections

Flow-through housing

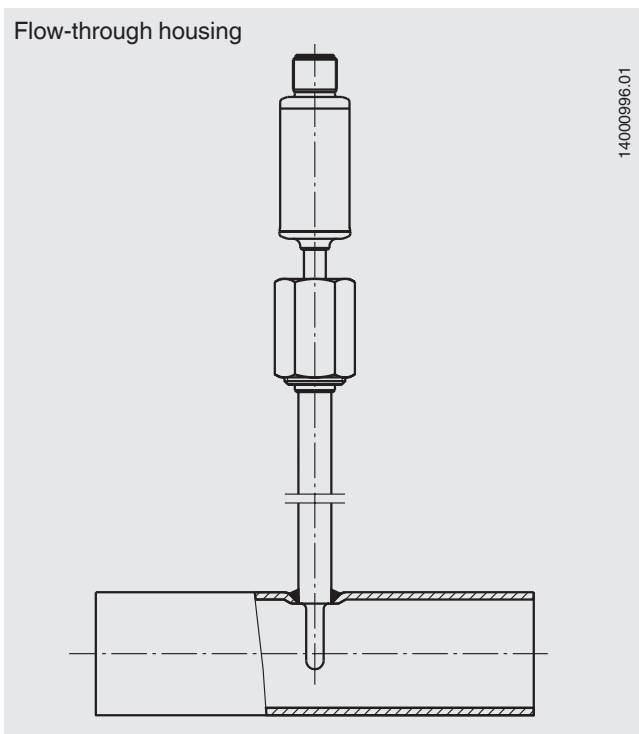

Angular housing

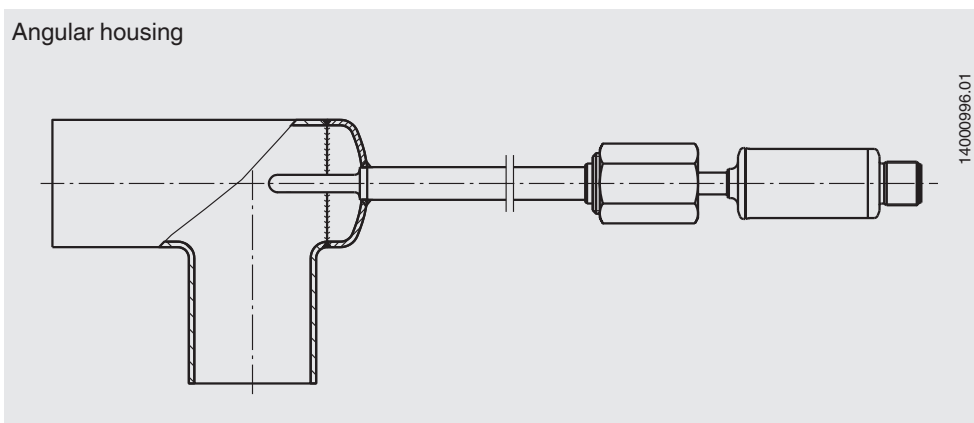

Dimensions of the process connections in mm (protection tube model TW61)

Flow-through housing

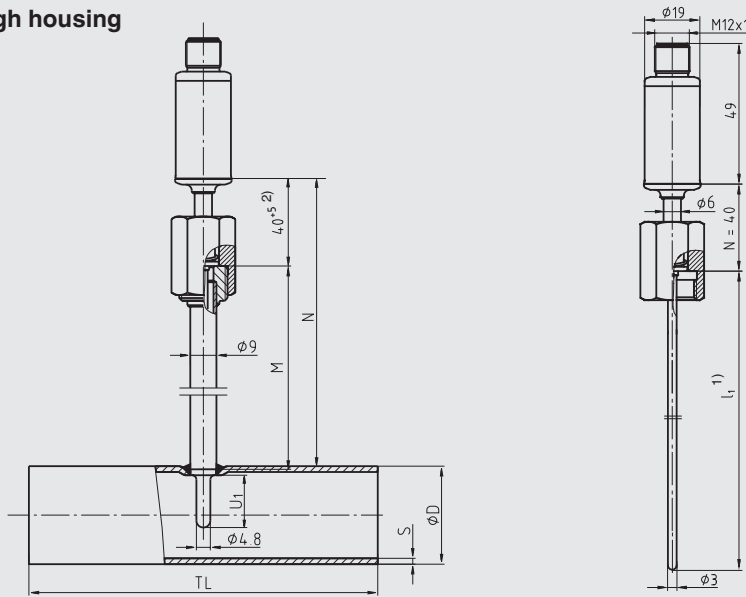

14000996.01

- 1) In the event of replacement, calculate the probe insertion length, l_1 , as follows:
 $l_1 (\text{TR21-B}) = U_1 + M + 3 \text{ mm}$
- 2) The tolerance specification is dependent on the spring travel of the sensor/probe

Nominal width of pipe		Nominal pressure in bar	Outer diameter of pipe	Pipe schedule	Pipe length	Protection tube insertion length	Neck tube length
DN / OD		PS ^{3) 4)}	Ø D	s	TL	U ₁	M
DIN 11866 row A or metric	10	25	13	1.5	70	6	51
	15	25	19	1.5	70	9	48
	20	25	23	1.5	80	11	46
	25	25	29	1.5	100	18	39
	32	25	35	1.5	110	18	39
	40	25	41	1.5	120	18	39
	50	25	53	1.5	160	30	27
	65	16	70	2.0	210	30	27
	80	16	85	2.0	260	45	32
DIN 11866 row B or ISO	8 (13.5)	25	13.5	1.6	64	6	51
	10 (17.2)	25	17.2	1.6	68	9	48
	15 (21.3)	25	21.3	1.6	72	11	46
	20 (26.9)	25	26.9	1.6	110	11	46
	25 (33.7)	25	33.7	2.0	120	18	39
	32 (42.4)	25	42.4	2.0	130	18	39
	40 (48.3)	25	48.3	2.0	130	18	39
	50 (60.3)	25	60.3	2.0	180	30	27
	65 (76.1)	16	76.1	2.0	220	30	27
	80 (88.9)	16	88.9	2.3	260	45	32
DIN 11866 row C or ASME BPE	1/2"	13.8	12.7	1.65	95.2	6	51
	3/4"	13.8	19.05	1.65	101.6	9	48
	1"	13.8	25.4	1.65	108.0	11	46
	1 1/2"	13.8	38.1	1.65	120.6	18	39
	2"	13.8	50.8	1.65	146.0	18	39
	2 1/2"	13.8	63.5	1.65	158.8	30	27
	3"	13.8	76.2	1.65	171.4	30	27
	4"	13.8	101.6	2.11	209.6	45	32

3) Maximum operating temperature 150 °C

4) All protection tubes of this series that are internally pressurised, with a nominal diameter (DN) > 25 mm, are manufactured and tested to module H of the pressure equipment directive.

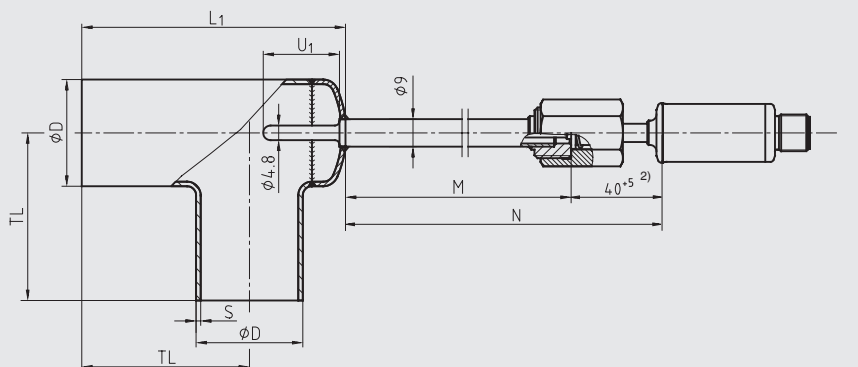

Angular housing

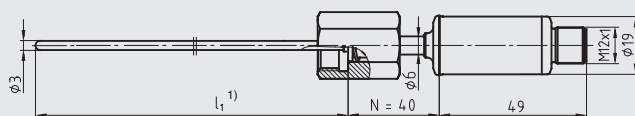

14000996.01

- 1) In the event of replacement, calculate the probe insertion length, l_1 , as follows:
 l_1 (TR21-B) = $U_1 + M + 3$ mm
 2) The tolerance specification is dependent on the spring travel of the sensor/probe



Nominal width of pipe		Nominal pressure in bar	Outer diameter of pipe	Pipe schedule	Pipe length		Protection tube insertion length	Neck tube length
DN / OD		PS ^{3) 4)}	Ø D	s	TL	L ₁	U ₁	M
DIN 11866 row A or metric	10	25	13	1.5	35	55	14	43
	15	25	19	1.5	35	55	18	39
	20	25	23	1.5	40	63	18	39
	25	25	29	1.5	50	77	30	27
DIN 11866 row A or metric 	32	25	35	1.5	55	87	30	27
	40	25	41	1.5	60	97	30	27
	50	25	53	1.5	80	126	30	27
	65	16	70	2.0	105	165	45	32
	80	16	85	2.0	130	201	45	32
	100	12.5	104	2.0	155	241	45	32
DIN 11866 row B or ISO	8 (13.5)	25	13.5	1.6	32	55	14	43
	10 (17.2)	25	17.2	1.6	34	55	16	41
	15 (21.3)	25	21.3	1.6	36	58	18	39
	20 (26.9)	25	26.9	1.6	55	81	30	27
DIN 11866 row B or ISO 	25 (33.7)	25	33.7	2.0	60	91	30	27
	32 (42.4)	25	42.4	2.0	65	102	30	27
	40 (48.3)	25	48.3	2.0	65	108	30	27
	50 (60.3)	25	60.3	2.0	90	145	45	32
	65 (76.1)	16	76.1	2.0	110	173	45	32
	80 (88.9)	16	88.9	2.3	130	203	45	32
DIN 11866 row C or ASME BPE	1/2"	13.8	12.7	1.65	47.6	71	14	43
	3/4"	13.8	19.05	1.65	50.8	71	18	39
	1"	13.8	25.4	1.65	54.0	79	18	39
DIN 11866 row C or ASME BPE 	1 1/2"	13.8	38.1	1.65	60.3	94	30	27
	2"	13.8	50.8	1.65	73.0	118	30	27
	2 1/2"	13.8	63.5	1.65	79.4	134	45	32
	3"	13.8	76.2	1.65	85.7	150	45	32
	4"	13.8	101.6	2.11	104.8	190	45	32

3) Maximum operating temperature 150 °C

4) All protection tubes of this series that are internally pressurised, with a nominal diameter (DN) > 25 mm, are manufactured and tested to module H of the pressure equipment directive.

Due to the variable neck tube length M measuring inserts with standardised insertion lengths l_1 can be used. This minimises the variations and, thus, the stockholding of spare parts. At the same time, it ensures the use of the correct insertion length in the event of replacement.

Connecting the PU-548 programming unit

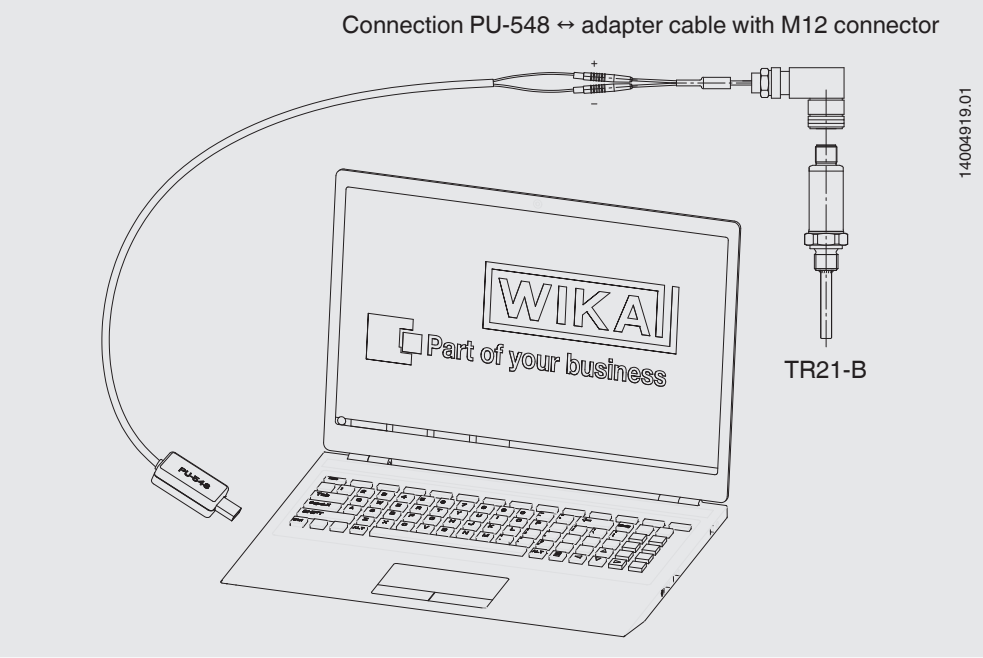

(predecessor, programming unit model PU-448, also compatible)

Application example

Temperature measurement for plant or measuring point validation

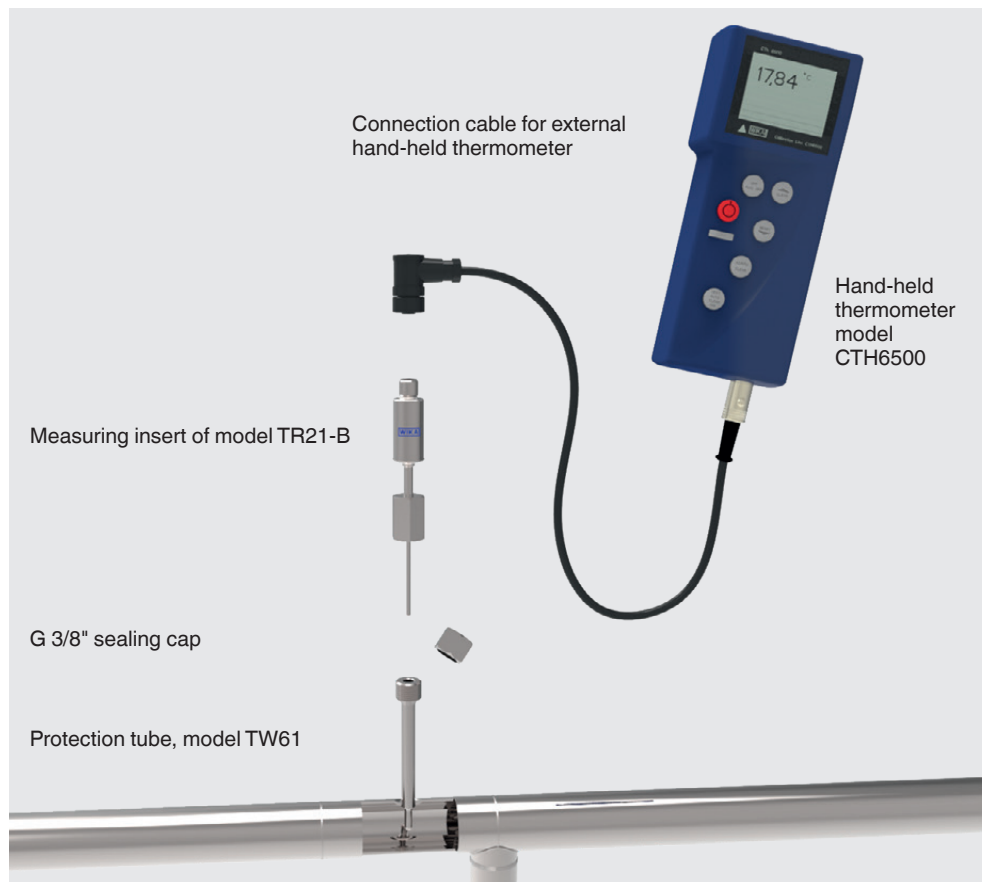

The measuring insert of the model TR21-B resistance thermometer, in combination with the model CTH6500 hand-held thermometer and the model TW61 protection tube, offers a simple and effective possibility for sterile validation of a temperature measuring point. Here, in the design phase, a model TW61 protection tube must be integrated in the pipeline, which will serve as the measuring point at a later date. To validate this measuring point, a resistance thermometer measuring insert with a spring-loaded tip is screwed into the protection tube and the temperature read from the connected hand-held thermometer.

Through a standardised probe insertion length, temperature measurement is possible using a single thermometer, even for protection tubes for different pipeline cross sections. The measuring point already available for the validation ensures that the sterile boundaries remain intact. Due to the defined contact pressure of the spring-loaded probe and the predetermined immersion depth in the pipeline, the temperature measurement is reproducible at any time. The time needed for the measurement is low.

Further components

Component	Order number
G 3/8" sealing cap	14136849
O-ring for use with G 3/8" sealing cap	0478709
Connection cable for the connection of model TR21-B resistance thermometers to model CTH6500 hand-held thermometers Cable length 2 m [6.56 ft]	14131257
Hand-held thermometer model CTH6500 (data sheet CT 55.10)	14007838

Hygienic design

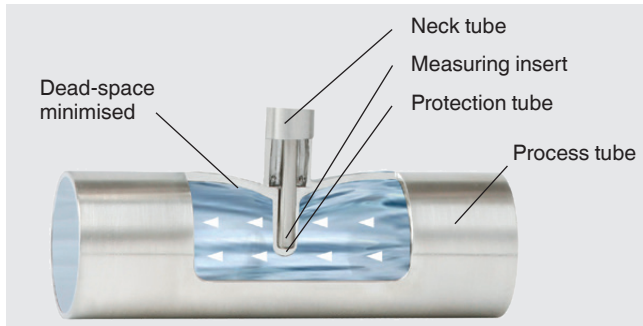



The patented hygienic design of the TW61 flow-through housing enables dead-space minimised, invasive temperature measurement and, through self-draining, a flexible mounting position.

With horizontal installation, make sure that the pipeline is slightly inclined for self-draining.

The installation is carried out by means of orbital welding. Thus, the weld seams are reproducible and controllable.

Accessories

Model	Description	Order no.		
 Programming unit Model PU-548	<ul style="list-style-type: none"> ■ Easy to use ■ LED status display ■ Compact design ■ No further voltage supply needed, neither for the programming unit nor for the transmitter (replaces programming unit model PU-448)	14231581		
 Adapter cable M12 to PU-548	Adapter cable for the connection of a model TR21-B resistance thermometer to the model PU-548 programming unit	14003193		
-	M12 sealing cap with mounted PTFE sealing	Sealing cap for protecting the resistance thermometer during sterilisation in autoclaves	14113588	
-	M12 connection cable	Cable socket straight, 4-pin, ingress protection IP67 Temperature range -20 ... +80 °C [-4 ... +176 °F] For hazardous areas	Cable length 2 m [6.56 ft]	14086880
			Cable length 5 m [16.40 ft]	14086883
		Cable socket straight., 4-pin, ingress protection IP69K, hygienic design Temperature range -40 ... +80 °C [-40 ... +176 °F] Not for hazardous areas	Cable length 3 m [9.84 ft]	14137167
			Cable length 5 m [16.40 ft]	14137168
		Angled socket, 4-pin, ingress protection IP67 Temperature range -20 ... +80 °C [-4 ... +176 °F] For hazardous areas	Cable length 2 m [6.56 ft]	14086889
			Cable length 5 m [16.40 ft]	14086891
	Angled socket, 4-pin, ingress protection IP69K, hygienic design Temperature range -40 ... +80 °C [-40 ... +176 °F] Not for hazardous areas	Cable length 3 m [9.84 ft]	14137169	
		Cable length 5 m [16.40 ft]	14137170	

Ordering information

Model / Approval / Sensor or transmitter output / Sensor specification or transmitter configuration / Process temperature / Protection tube / Process connection / Material of wetted parts / Insertion length U₁ / Electrical accessories / Certificates / Options

© 12/2010 WIKA Alexander Wiegand SE & Co. KG, all rights reserved.
The specifications given in this document represent the state of engineering at the time of publishing.
We reserve the right to make modifications to the specifications and materials.

