

Bimetal thermometer

Process version per ASME B40.200

Model TG53

WIKA data sheet TM 53.02



for further approvals
see page 6

Applications

- General process instrumentation in the chemical and petrochemical industries, oil and gas industries, power generation and water/wastewater industries
- Temperature measurement in harsh and aggressive environments
- Suitable for applications with high vibrations

Special features

- Robust, hermetically sealed case
- Accuracy: $\pm 1\%$ of full scale value ASME B40.200 (grade A)
- External reset for setting the reference temperature
- Dished dial (anti-parallax) for ease of reading
- Adjustable stem and dial version enables optimal process connection



Fig. left: Back mount (axial)

Fig. right: Back mount, adjustable stem and dial

Description

The model TG53 bimetal thermometer has been developed and manufactured in accordance with the ASME B40.200 standard. The thermometer provides high quality and performance, and is an ideal choice in the process industries.

The robust, hermetically sealed case with standard IP66 (NEMA 4X) ingress protection enables use within harsh external conditions.

Specifically designed for use in the chemical and petrochemical, oil and gas, power engineering and shipbuilding industries, the TG53 satisfies the rigorous requirements for resistance to aggressive media. As an available option, the case, stem and process connection can be made from 316 stainless steel.

The TG53 offers the widest variety of dampening options in the industry, allowing it to operate in situations where severe vibration conditions exist. These options include case filling and a damped bearing bushing to minimise pointer oscillation.

An easily accessible reset screw on the back of the case allows quick, limited reference temperature adjustment, reducing maintenance and recalibration costs.

The TG53 is also available in an assortment of stem lengths (insertion length L_1) to optimise its application-specific fit and performance.

Specifications

Detailed views

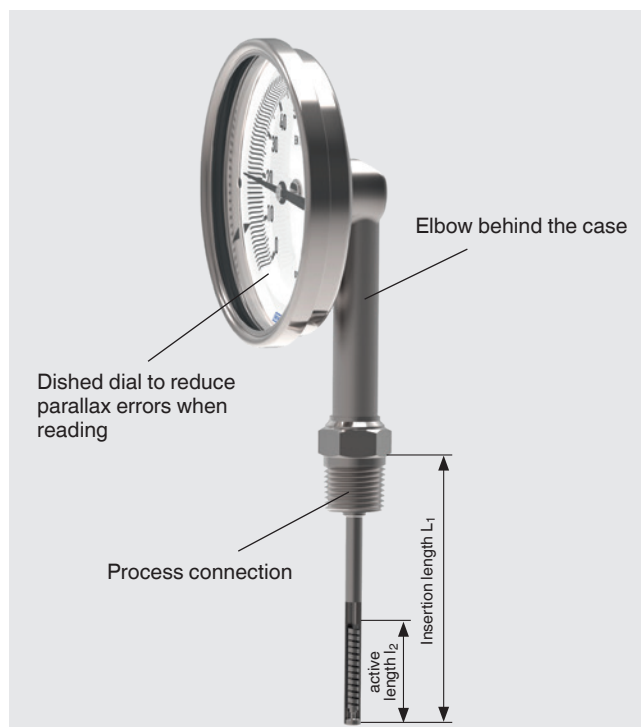
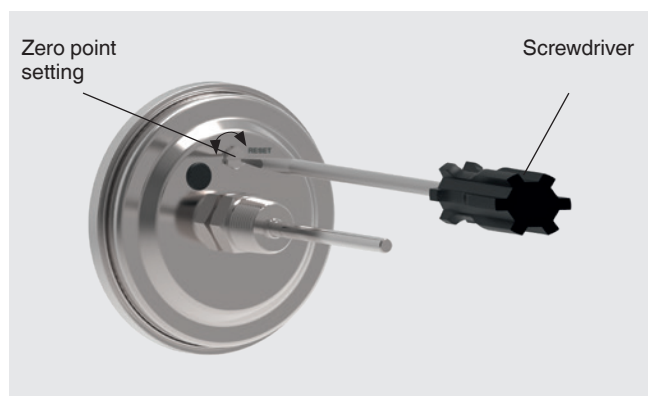

Basic information	
Standard	ASME B40.200
Nominal size	<ul style="list-style-type: none"> ■ 3" [80 mm] ■ 4" [100 mm] ■ 5" [127 mm] ■ 6" [160 mm]
Window	<ul style="list-style-type: none"> ■ Instrument glass ■ Laminated safety glass ■ Polycarbonate (shatterproof)
Connection location	<ul style="list-style-type: none"> ■ Back mount (axial) ■ Lower mount (radial) ■ Back mount, adjustable stem and dial
Connection design	→ For drawings, see page 7
S	Standard (male threaded connection)
1	Plain stem (without thread)
2	Male nut
3	Union nut
4	Compression fitting (sliding on stem)
4.1	Compression fitting with support tube sliding on stem
Versions	<ul style="list-style-type: none"> ■ Standard version ■ Oil- and grease-free version ■ Silicone-oil-less version
"Adjustable stem and dial" case version	Swivelling 90° and rotatable 360°
Dampening, case filling	<ul style="list-style-type: none"> ■ Without ■ With silicone oil case filling, up to max. 482 °F [250 °C] (at the probe) ■ Damped bearing bushing (with inert gel)

Basic information	
Material (in contact with the environment)	
Case, ring	<ul style="list-style-type: none"> ■ Stainless steel 304 ■ Stainless steel 316L
Elbow behind the case (only with lower mount)	<ul style="list-style-type: none"> ■ Stainless steel 304 ■ Stainless steel 316L
Articulated joint ("adjustable stem and dial")	<ul style="list-style-type: none"> ■ Stainless steel 304 ■ Stainless steel 316L

Measuring element	
Type of measuring element	Bimetal coil
Nominal effective range	
Continuous load (1 year)	Measuring range (EN 13190)
Short time (max. 24 h)	Scale range (EN 13190)

Accuracy specifications	
Accuracy	Grade A per ASME B40.200
Zero adjustment (option)	On the rear side of the case, external only for adjustable stem and dial





Scale range in °C	Scale spacing in °C
-70 ... +70	2
-70 ... +30	1
-60 ... +50	1
-50 ... +50	1
-50 ... +100	2
-50 ... +200	5
-50 ... +300	5
-50 ... +400	5
-50 ... +500	10
-40 ... +40	1
-40 ... +60	1
-40 ... +80	2
-40 ... +160	2
-30 ... +30	1
-30 ... +50	1
-30 ... +70	1
-20 ... +40	1
-20 ... +60	1
-20 ... +80	1
-20 ... +100	2
-20 ... +120	2
-20 ... +140	2
-10 ... +50	1
0 ... 60	1
0 ... 80	1
0 ... 100	1

Scale range in °C	Scale spacing in °C
0 ... 120	2
0 ... 150	2
0 ... 160	2
0 ... 200	2
0 ... 250	5
0 ... 300	5
0 ... 400	5
0 ... 500	5
0 ... 600	5

Scale range in °F	Scale spacing in °F
-100 ... +150	5
-80 ... +120	2
-80 ... +240	5
-40 ... +120	2
0 ... 140	2
0 ... 200	2
0 ... 250	5
30 ... 300	2
30 ... 400	5
50 ... 400	5
100 ... 800	10
150 ... 750	5
200 ... 1,000	10

Further details on: scale range		
Unit	<ul style="list-style-type: none"> ■ °F ■ °C ■ °F/°C (dual scale) ■ °C/°F (dual scale) 	
Overtemperature resistance ¹⁾		
Scale range -94 ... +250 °F [-70 ... +120 °C]	100 % overload safety of scale range	
Scale range 250 ... 550 °F [120 ... 280 °C]	50 % overload safety of scale range	
Scale range 550 ... 750 °F [280 ... 400 °C]	Max. 800 °F [430 °C] of scale range	
Scale range 750 ... 1,000 °F [400 ... 600 °C]	Max. full scale value	
Dial		
Scale graduation	<ul style="list-style-type: none"> ■ Single scale ■ Dual scale 	
Scale colour	Single scale	Black
	Dual scale	Red
		Others on request
Material	Aluminium	
Pointer		
Version	Adjustable pointer	
Pointer colour	Black	
Material	Aluminium	

1) Overtemperature resistance only in non-hazardous areas

Process connection	
Thread size	<ul style="list-style-type: none"> ■ Plain, without thread ■ G ½ B ■ ½ NPT ■ G ½ female ■ ½ NPT female ■ M20 x 1.5 ■ M24 x 1.5 female <p>Others on request</p>
Material (wetted)	<ul style="list-style-type: none"> ■ Stainless steel 304 ■ Stainless steel 316L
Stem	
Diameter	<ul style="list-style-type: none"> ■ ¼" [6.35 mm] ■ ⅜" [9.53 mm]
Material (wetted)	Stainless steel 304 (option: stainless steel 316L)
Thermowell/protection tube	<p>In principle, the operation of a mechanical thermometer is possible without a thermowell/protection tube with low process-side loading (low pressure, low viscosity and low flow velocities).</p> <p>However, in order to enable exchanging the thermometer during operation (e.g. instrument replacement or calibration) and to ensure a better protection of the instrument and also the plant and the environment, it is advisable to use a thermowell/protection tube from the extensive WIKA portfolio.</p> <p>→ For further information on the wake frequency calculation, see Technical information IN 00.15.</p>
Model TW10	 <p>→ see data sheet TW 95.10</p>
Model TW15	 <p>→ see data sheet TW 95.15</p>
Model TW20	 <p>→ see data sheet TW 95.20</p>
Model TW25	 <p>→ see data sheet TW 95.25</p>







Process connection		
Model TW30		→ see data sheet TW 95.30
ScrutonWell® design		→ see data sheet SP 05.16

Operating conditions			
Ambient temperature range (at the case)	unfilled	filled	Option
Instrument glass	-40 ... +212 °F ¹⁾ [-40 ... +100 °C]	-	-60 ... +160 °F [-50 ... +70 °C]
Laminated and polycarbonate window	-40 ... +160 °F ¹⁾ [-40 ... +70 °C]	-40 ... +160 °F [-40 ... +70 °C]	-60 ... +160 °F [-50 ... +70 °C]
Storage temperature range			
Without liquid dampening	-60 ... +160 °F [-50 ... +70 °C]		
With liquid dampening	-50 ... +160 °F [-40 ... +70 °C]		
Damped bearing bushing (option)	-60 ... +160 °F [-50 ... +70 °C]		
Max. operating pressure at stem	Max. 25 bar, static		
Ingress protection (IP code) per IEC/EN 60529	<ul style="list-style-type: none"> ■ IP66 (NEMA 4X) ■ IP67 ■ IP68 (continuous immersion to 5 m) 		
Insertion length L₁	2.5" ... 39" [63 ... 1,000 mm] Other lengths > 39" [1,000 mm] on request Minimum/maximum length is dependent on the measuring range and diameter		

1) With ambient temperatures < 32 °F [0 °C] the measuring system and the window can fog and possibly even frost up.

Approvals

Optional approvals

Logo	Description	Country
	EU declaration of conformity ATEX directive Hazardous areas - Ex h Zone 1 gas II 2G Ex h IIC T6 ... T1 Gb X Zone 20 dust II 2D Ex h IIIC T85 ... T450 °C Db X	European Union
	GOST Metrology, measurement technology	Russia
	KazInMetr Metrology, measurement technology	Kazakhstan
-	MTSCHS Permission for commissioning	Kazakhstan
	BelGIM Metrology, measurement technology	Belarus
	Uzstandard Metrology, measurement technology	Uzbekistan
-	CRN Safety (e.g. electr. safety, overpressure, ...)	Canada
	DNV GL (option) Type approval for the shipbuilding industry - Nominal size: 3" [80 mm], 4" [100 mm] - Dampening: With liquid dampening - Maximum insertion length: 500 mm Location classification: Humidity DNVGL-CG-0339, section 3, class B Salt fog DNVGL-CG-0339, section 3, class D Vibration DNVGL-CG-0339, section 3, class B Use of a thermowell/protection tube is mandatory.	International

Certificates (option)

Certificates	
Certificates	<ul style="list-style-type: none"> ■ 2.2 test report ■ 3.1 inspection certificate

Approvals and certificates, see website

Connection designs

Standard design (male threaded connection)

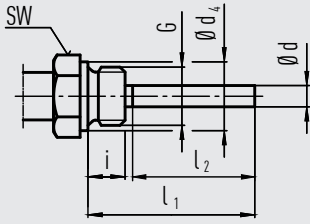

Connection, male: ¼ NPT, ½ NPT, G ¼ B, G ½ B
 Standard insertion length $l_1 = 2.5", 4", 6", 9", 12", 15", 18", 24"$
 Recommendation: For applications with vibration on the process side

Nominal size	Process connection		Dimensions in mm / in		
	G	i	SW	d₄	Ø d
NS	G	i	SW	d₄	Ø d
3", 4", 5", 6"	G ½ B	14	27	26	■ ¼" ■ ⅜"
	½ NPT	19	22	-	■ ¼" ■ ⅜"

Design 1, plain stem (without thread)

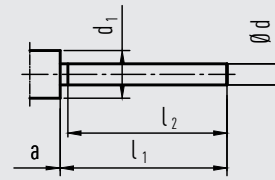

Standard insertion length $l_1 = 6", 7", 9", 11"$
 Basis for design 4, compression fitting

Nominal size	Dimensions in mm / in			
	d₁	Ø d	a for axial	a for adjustable stem and dial
NS	d₁	Ø d	a for axial	a for adjustable stem and dial
3", 4", 5", 6"	18	0.31"	15	25

3073050.06

Design 2, male nut

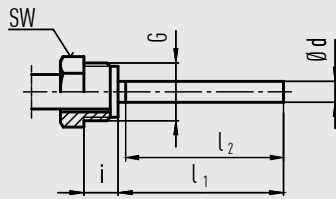

Standard insertion length $l_1 = 3", 5", 7", 9"$
 Non-sealing process connection, thus use with thermowell/protection tube.

Nominal size	Process connection		Dimensions in mm / in	
	G	i	SW	Ø d
NS	G <th>i</th> <th>SW</th> <th>Ø d</th>	i	SW	Ø d
3", 4", 5", 6"	G ½ B	20	27	■ ¼" ■ ⅜"

Design 3, union nut

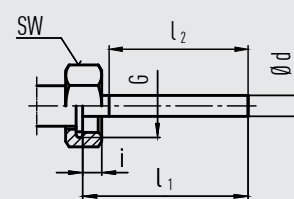

Standard insertion length $l_1 = 4", 5", 7", 9", 10"$

Nominal size	Process connection		Dimensions in mm / in	
	G	i	SW	Ø d
NS	G <th>i</th> <th>SW</th> <th>Ø d</th>	i	SW	Ø d
3", 4", 5", 6"	G ½ B	8.5	27	■ ¼" ■ ⅜"
	M24 x 1.5	13.5	32	■ ¼" ■ ⅜"

3073050.06

Design 4, compression fitting (sliding on stem)

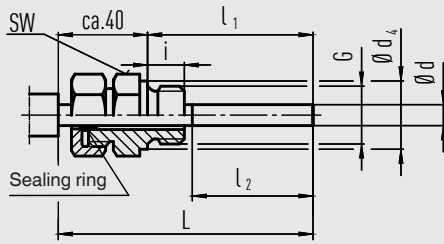

Insertion length $l_1 = 2.5", 4", 6", 7", 10"$
 Length $L = l_1 + 40 \text{ mm}$

Nominal size	Process connection		Dimensions in mm / in			
	G	i	SW	d_4	$\varnothing d$	
3", 4", 5", 6"	G 1/2 B	14	27	26	■ 1/4" ■ 3/8"	
	1/2 NPT	19	22	-	■ 1/4" ■ 3/8"	

Design 4.1, compression fitting with support tube sliding on stem

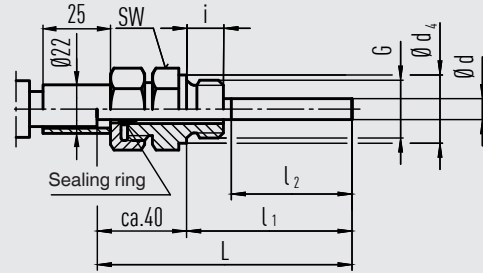

Insertion length $l_1 = 2.5", 4", 6", 7", 10"$
 Length $L = l_1 + 40 \text{ mm}$

Nominal size	Process connection		Dimensions in mm / in			
	G	i	SW	d_4	$\varnothing d$	
3", 4", 5", 6"	G 1/2 B	14	27	26	■ 1/4" ■ 3/8"	
	1/2 NPT	19	22	-	■ 1/4" ■ 3/8"	

Legend:

- G Male thread
- i Thread length (incl. collar)
- a Distance to the case/articulated joint
- $\varnothing d_4$ Diameter of the sealing collar
- SW Spanner width
- $\varnothing d$ Stem diameter
- l_1 Insertion length
- l_2 Active length

Dimensions in mm / in

Back mount (axial)

G thread

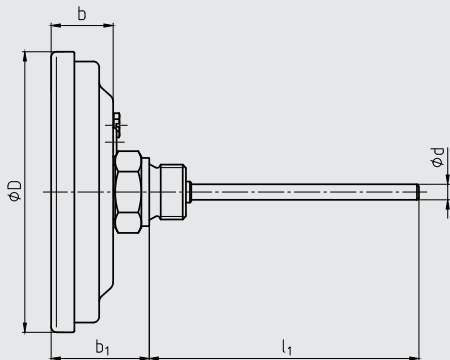

14183333.01

NPT thread

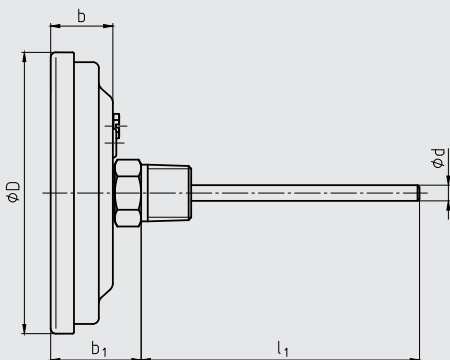

Lower mount (radial)

G thread

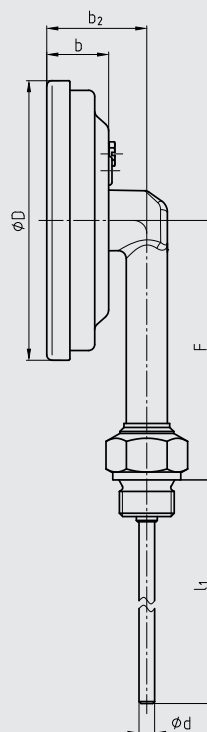

NPT thread

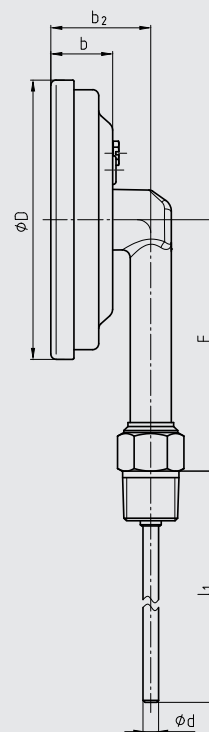

14183334.02

Nominal size	Dimensions in mm / in							
	ϕD	ϕd	b	b_1 ¹⁾		b_2	F	
				G thread	NPT thread		G thread	NPT thread
3"	83	■ 1/4" ■ 3/8"	23	44	37	38	88	84
4"	107	■ 1/4" ■ 3/8"	24	45	38	39	100	95
5"	134	■ 1/4" ■ 3/8"	23	44	37	38	113	109
6"	167	■ 1/4" ■ 3/8"	24	45	38	39	130	125

1) With scale ranges $\geq 0 \dots 300$ °C the dimensions increase by 40 mm

Back mount, adjustable stem and dial

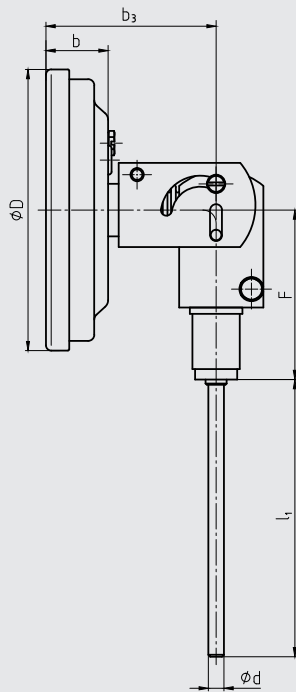

14183335.02

Nominal size	Dimensions in mm / in				
NS	Ø D	Ø d	b	b ₃	F
3"	83	■ 1/4" ■ 3/8"	23	64	67
4"	107	■ 1/4" ■ 3/8"	24	65	67
5"	134	■ 1/4" ■ 3/8"	23	64	67
6"	167	■ 1/4" ■ 3/8"	24	65	67

Ordering information

Model / Nominal size / Connection location / Connection design / Unit / Scale range / Process connection / Stem diameter / Insertion length l_1 / Approvals / Certificates / Options

© 10/2018 WIKA Alexander Wiegand SE & Co. KG, all rights reserved.
The specifications given in this document represent the state of engineering at the time of publishing.
We reserve the right to make modifications to the specifications and materials.

