



# WINNER 4N

## POMPY GŁĘBINOWE DO STUDNI 4"

Nowe czterocalowe pompy do studni głębinowych przeznaczone do zasilania w wodę budynków mieszkalnych i przemysłowych, nawadniania upraw, itp.



Nowość

### SPECYFIKACJA

- Maksymalna temperatura wody: 40°C (zależnie od zastosowanego silnika)
- Maksymalna zawartość piasku: 50 ppm
- Maksymalna głębokość zanurzenia:  
150 m dla pomp z silnikami olejowymi (OY)  
350 m dla pomp z silnikami wodnymi (WY)

### MATERIAŁY

- Płaszcz pompy, wał, korpus tłoczny oraz zawór zwrotny: stal AISI 304
- Wirniki: technopolimer
- Dyfuzory: PPO zbrojony włóknem szklanym

### DANE TECHNICZNE

- Silniki 2 biegunowe, z wypełnieniem wodnym (WY) lub olejowym (OY)
- Klasa izolacji F (OY), B (WY)
- Maksymalna ilość zatańczeń: 35 (OY), 30 (WY)
- Stopień ochrony: IP58 (OY), IP68 (WY)
- Zasilanie: 1~230V (+6%-10%), 50 Hz (OYM) lub 3~400V (+6%-10%), 50 Hz (OY)  
1~230V (±6%), 50 Hz (WYM) lub 3~400V (±6%), 50 Hz (WY)
- Króciec tłoczny: 1"1/4 dla modeli 4N1, 4N2, 4N4  
2" dla modeli 4N7, 4N10, 4N15



# WINNER 4N

POMPY GŁĘBINOWE DO STUDNI 4"

## WYMIARY WINNER 4N

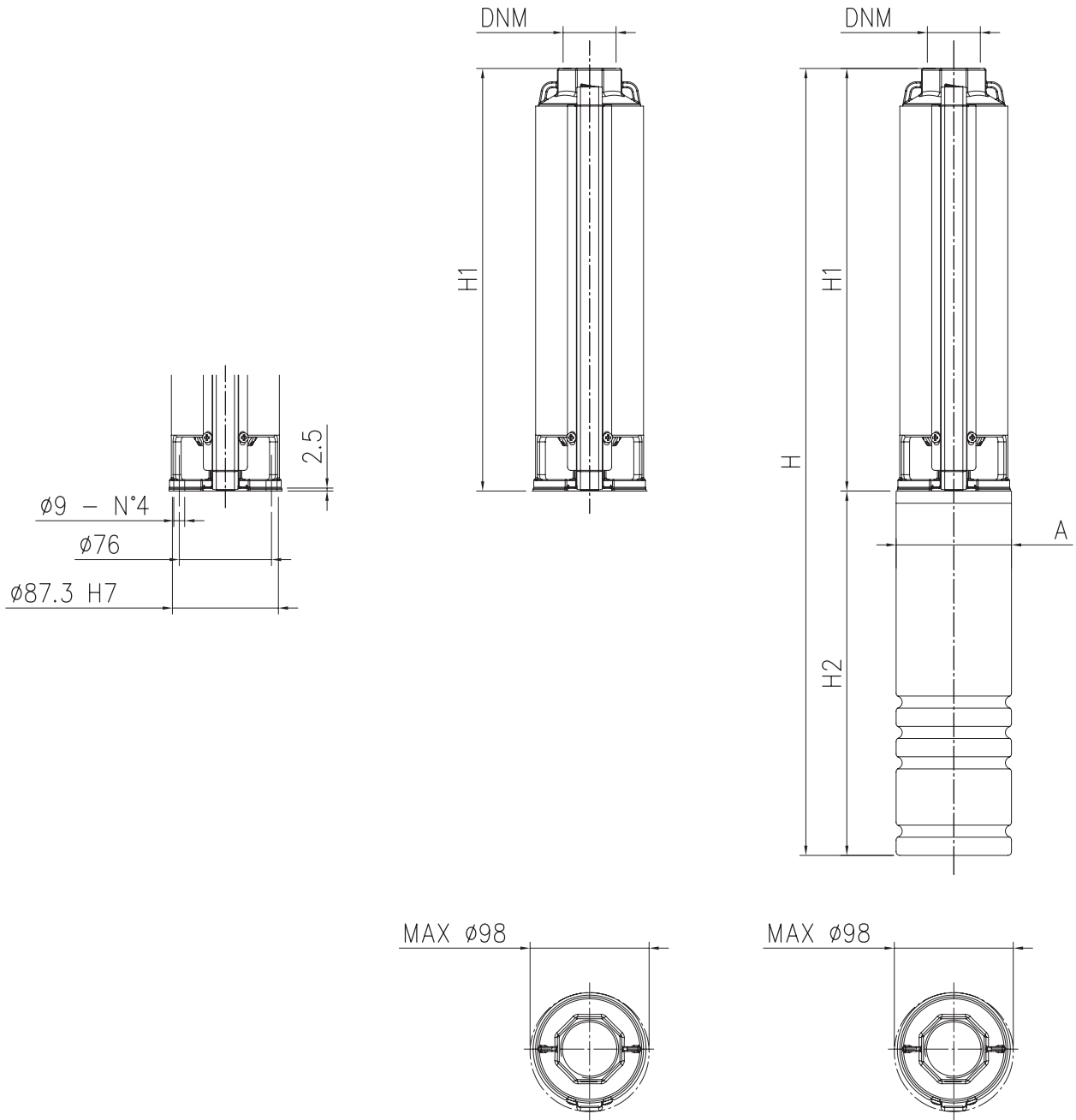



# WINNER 4N

## POMPY GŁĘBINOWE DO STUDNI 4"

**TABELA WYMIARÓW**

Typ pompy	Moc		Pompa bez silnika		Pompa z silnikiem olejowym						Pompa z silnikiem wodnym					
					jednofazowym			trójfazowym			jednofazowym			trójfazowym		
	kW	HP	H1	DNM (mm)	A (mm)	H2 (mm)	H (mm)	A (mm)	H2 (mm)	H (mm)	A (mm)	H2 (mm)	H (mm)	A (mm)	H2 (mm)	H (mm)
4N1/12	0,37	0,5	332	G 1 1/4"	97	325	657	97	304	636	97	242	574	97	223	555
4N1/18	0,55	0,75	437	G 1 1/4"	97	325	762	97	325	762	97	271	708	97	242	679
4N1/24	0,75	1	542	G 1 1/4"	97	350	892	97	325	867	97	299	841	97	271	813
4N1/34	1,1	1,5	717	G 1 1/4"	97	385	1102	97	350	1067	97	356	1073	97	299	1016
4N1/48	1,5	2	1028	G 1 1/4"	97	420	1448	97	385	1413	97	384	1412	97	327	1355
4N1/68	2,2	3	1378	G 1 1/4"	97	470	1848	97	420	1798	97	460	1838	97	356	1734
4N2/7	0,37	0,5	245	G 1 1/2"G	97	325	570	97	304	549	97	242	487	97	223	468
4N2/10	0,55	0,75	297	1 1/2"	97	325	622	97	325	622	97	271	568	97	242	539
4N2/14	0,75	1	367	G 1 1/2"G	97	350	717	97	325	692	97	299	666	97	271	638
4N2/20	1,1	1,5	472	1 1/2"G	79	385	857	79	350	822	79	356	828	79	299	771
4N2/28	1,5	2	612	1 1/2"G	97	420	1032	97	385	997	97	384	996	97	327	939
4N2/40	2,2	3	888	1 1/2"G	97	470	1358	97	420	1308	97	460	1348	97	356	1244
4N2/56	3	4	1168	1 1/2"G	97	-	-	97	544	1712	97	-	-	97	423	1591
4N4/4	0,37	0,5	208	1 1/4"	97	325	533	97	304	512	97	242	450	97	223	431
4N4/7	0,55	0,75	273	G 1 1/2"G	97	325	598	97	325	598	97	271	544	97	242	515
4N4/9	0,75	1	316	1 1/2"G	97	350	666	97	325	641	97	299	615	97	271	587
4N4/13	1,1	1,5	402	1 1/2"G	97	385	787	97	350	752	97	356	758	97	299	701
4N4/18	1,5	2	509	1 1/2"	97	420	929	97	385	894	97	384	893	97	327	836
4N4/27	2,2	3	703	G 1 1/2"G	97	470	1173	97	420	1123	97	460	1163	97	356	1059
4N4/36	3	4	962	1 1/2"G	97	-	-	97	544	1506	97	-	-	97	423	1385
4N4/48	4	5,5	1220	1 1/2"	97	-	-	97	574	1794	97	-	-	97	583	1803
4N7/4	0,55	0,75	262	G 2"	97	325	587	97	325	587	97	271	533	97	242	504
4N7/6	0,75	1	333	G 2"	97	350	683	97	325	658	97	299	632	97	271	604
4N7/8	1,1	1,5	404	G 2"	97	385	789	97	350	754	97	356	760	97	299	703
4N7/12	1,5	2	546	G 2"	97	420	966	97	385	931	97	384	930	97	327	873
4N7/17	2,2	3	724	G 2"	97	470	1194	97	420	1144	97	460	1184	97	356	1080
4N7/23	3	4	937	G 2"	97	-	-	97	544	1481	97	-	-	97	423	1360
4N7/30	4	5,5	1251	G 2"	97	-	-	97	574	1825	97	-	-	97	583	1834
4N7/42	5,5	7,5	1677	G 2"	97	-	-	97	644	2321	97	-	-	97	698	2375
4N10/4	0,75	1	262	G 2"	97	350	612	97	325	587	97	299	561	97	271	533
4N10/6	1,1	1,5	333	G 2"	97	385	718	97	350	683	97	356	689	97	299	632
4N10/8	1,5	2	404	G 2"	97	420	824	97	385	789	97	384	788	97	327	731
4N40/12	2,2	3	546	G 2"	97	470	1016	97	420	966	97	460	1006	97	356	902
4N10/17	3	4	724	G 2"	97	-	-	97	544	1268	97	-	-	97	423	1147
4N10/23	4	5,5	937	G 2"	97	-	-	97	574	1511	97	-	-	97	583	1520
4N10/30	5,5	7,5	1251	G 2"	97	-	-	97	644	1895	97	-	-	97	698	1949
4N10/42	7,5	10	1677	G 2"	97	-	-	97	805	2482	97	-	-	97	774	2451
4N15/4	1,1	1,5	440	G 2"	79	385	825	79	350	790	79	356	796	79	299	739
4N15/6	1,5	2	600	G 2"	97	420	1020	97	385	985	97	384	984	97	327	927
4N15/9	2,2	3	840	G 2"	97	470	1310	97	420	1260	97	460	1300	97	356	1196
4N15/13	3	4	1160	G 2"	97	-	-	97	544	1704	97	-	-	97	423	1583
4N15/17	4	5,5	1480	G 2"	97	-	-	97	574	2054	97	-	-	97	583	2063
4N15/24	5,5	7,5	2106	G 2"	97	-	-	97	644	2750	97	-	-	97	698	2804

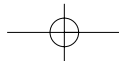

# WINNER 4N

POMPY GŁĘBINOWE DO STUDNI 4"

## CHARAKTERYSTYKI HYDRAULICZNE 4N1

(w/g ISO 9906 Aneks A)

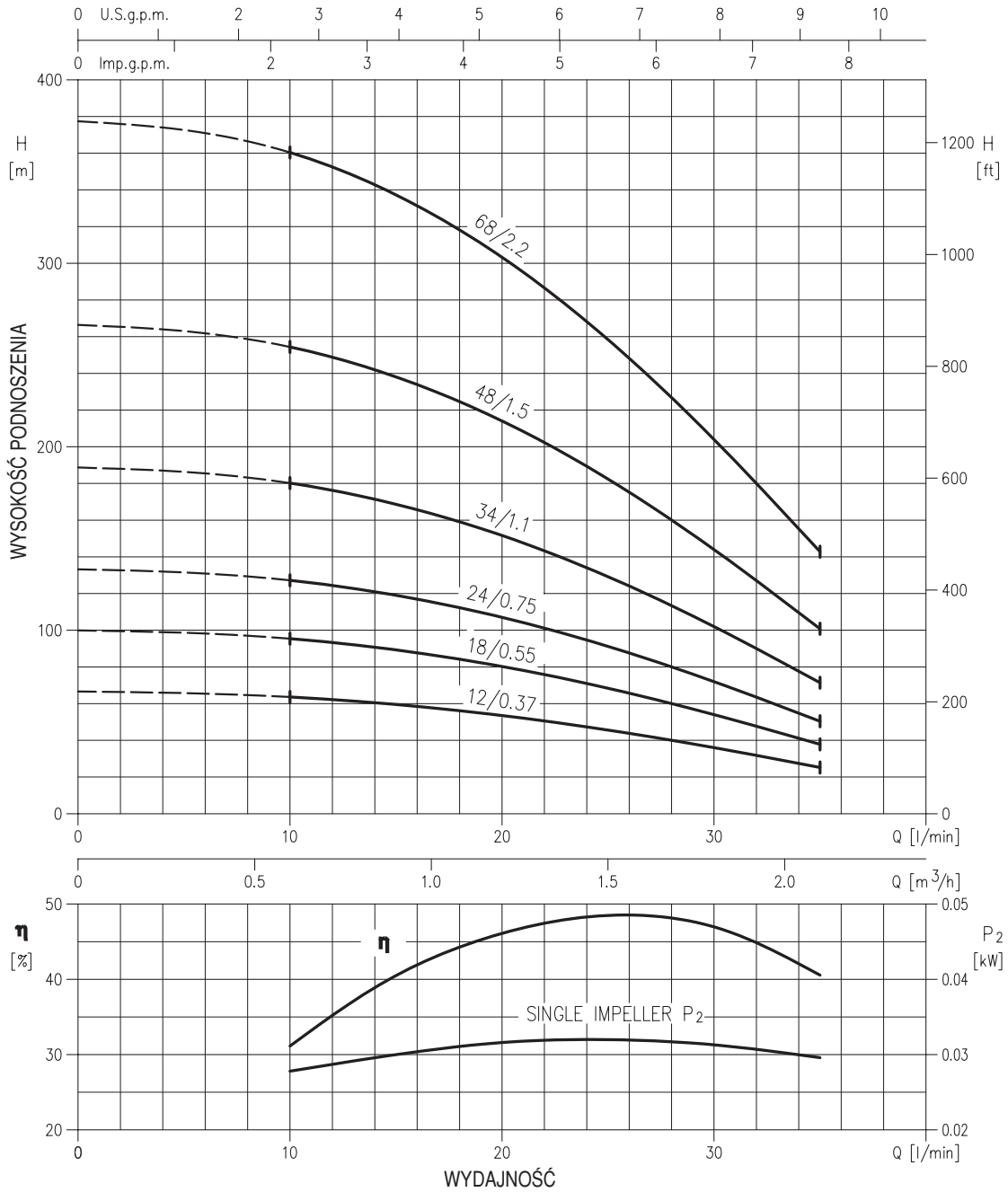

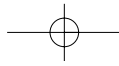

# WINNER 4N

POMPY GŁĘBINOWE DO STUDNI 4"

## CHARAKTERYSTYKI HYDRAULICZNE 4N2

(w/g ISO 9906 Aneks A)

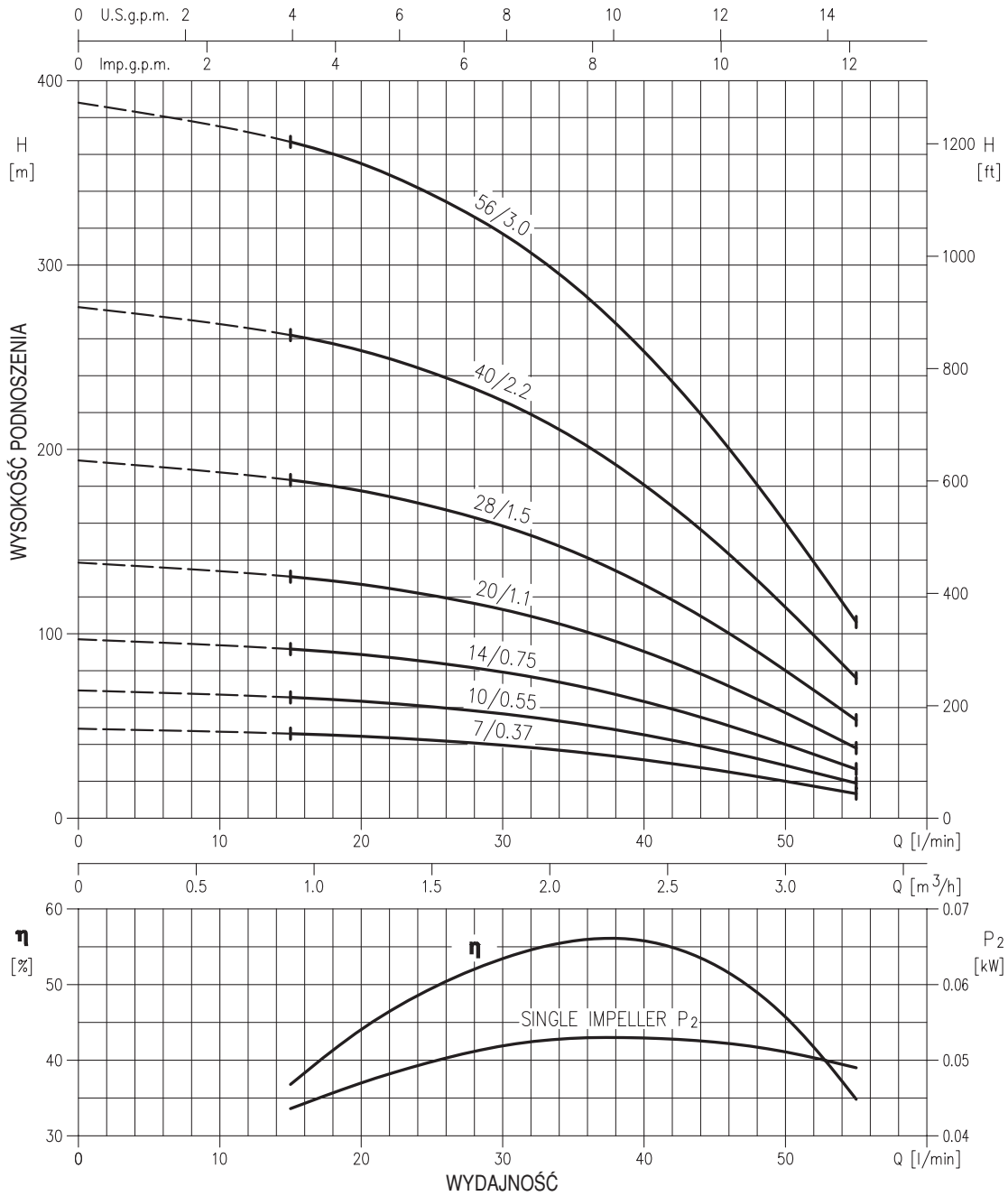

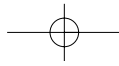

# WINNER 4N

POMPY GŁĘBINOWE DO STUDNI 4"

## CHARAKTERYSTYKI HYDRAULICZNE 4N4

(w/g ISO 9906 Aneks A)

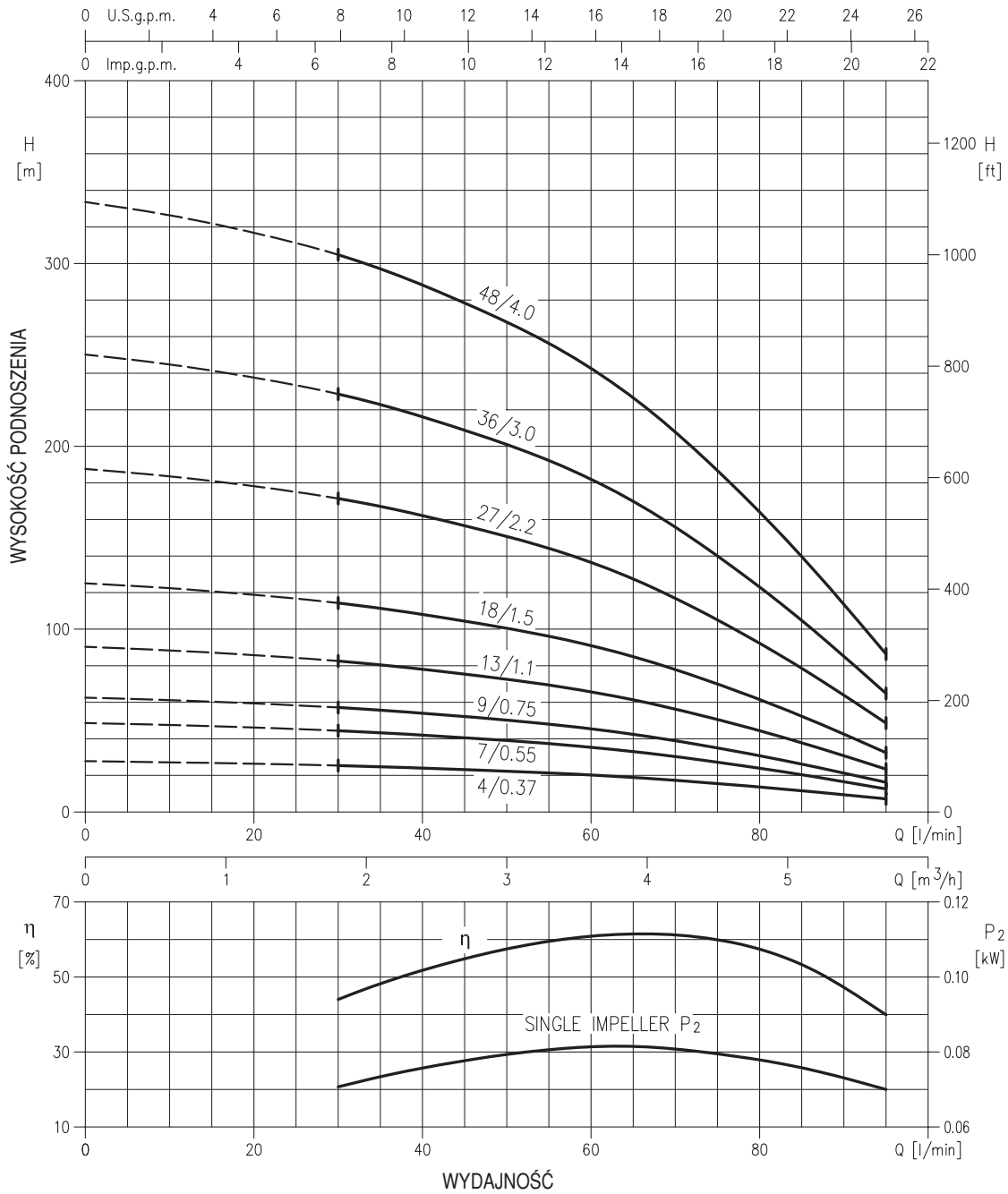

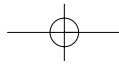

# WINNER 4N

POMPY GŁĘBINOWE DO STUDNI 4"

## CHARAKTERYSTYKI HYDRAULICZNE 4N7

(w/g ISO 9906 Aneks A)

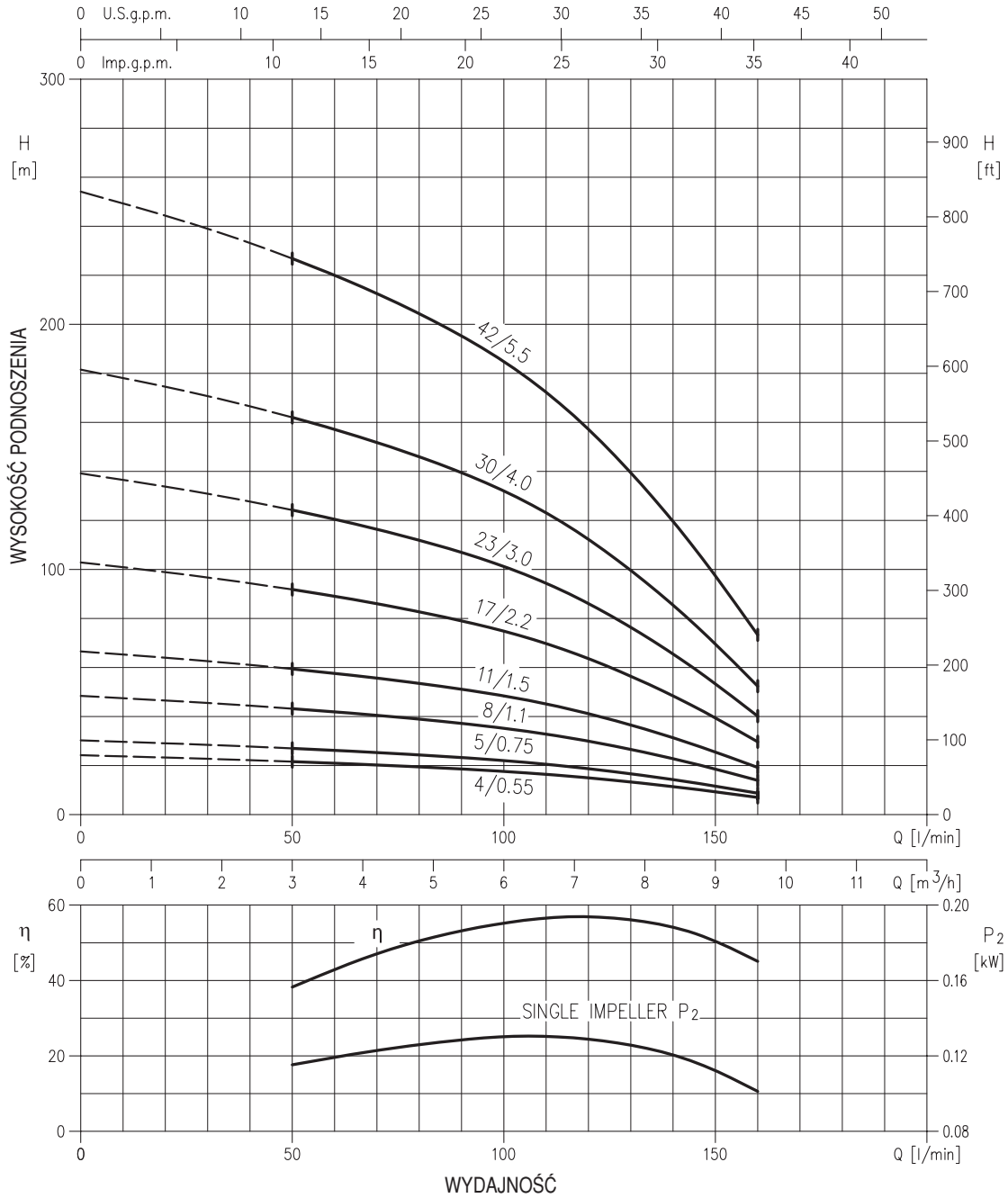

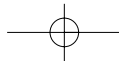

# WINNER 4N

POMPY GŁĘBINOWE DO STUDNI 4"

## CHARAKTERYSTYKI HYDRAULICZNE 4N10

w/g ISO 9906 Aneks A)

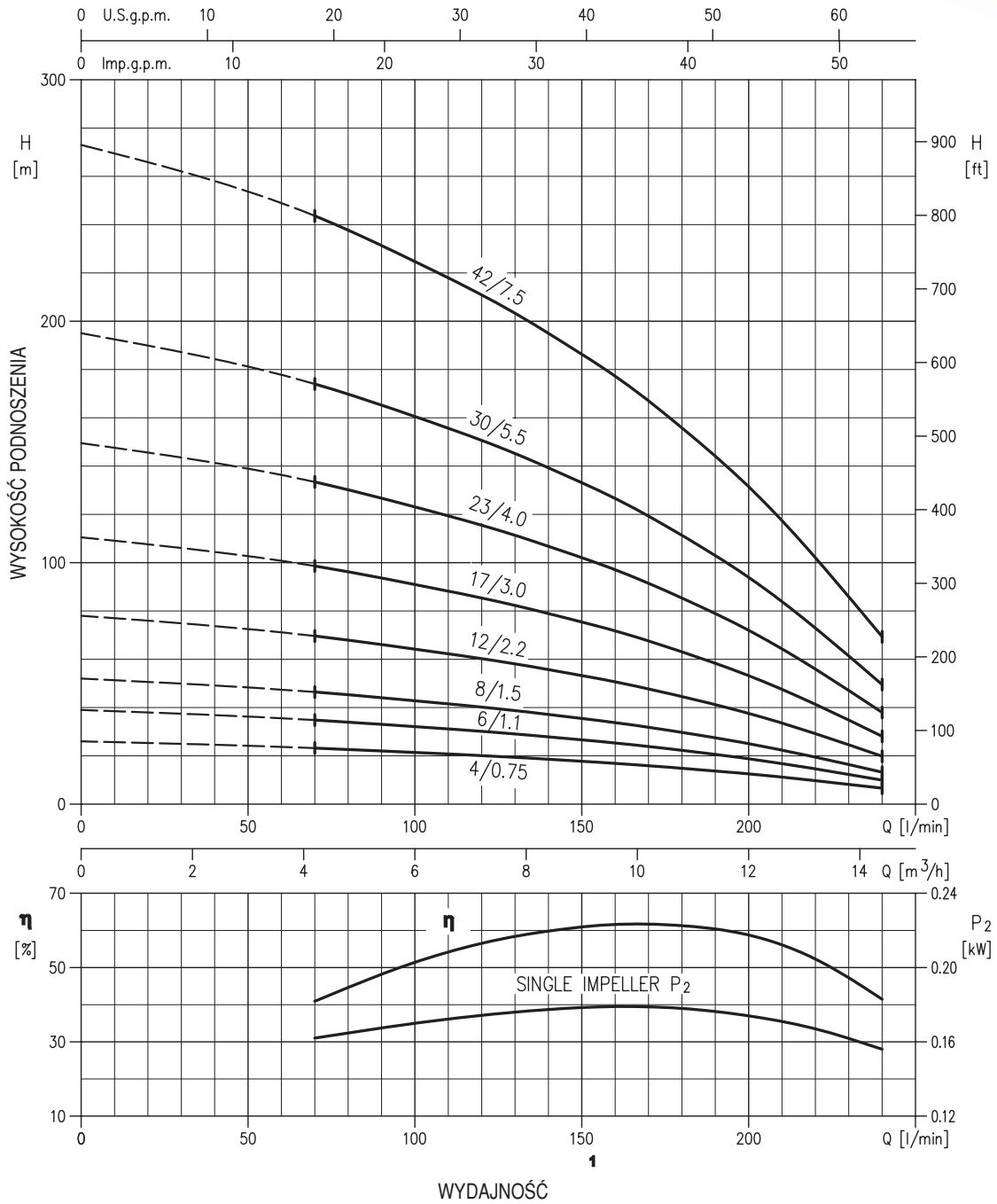





# WINNER 4N

POMPY GŁĘBINOWE DO STUDNI 4"

## CHARAKTERYSTYKI HYDRAULICZNE 4N15

(w/g ISO 9906 Aneks A)

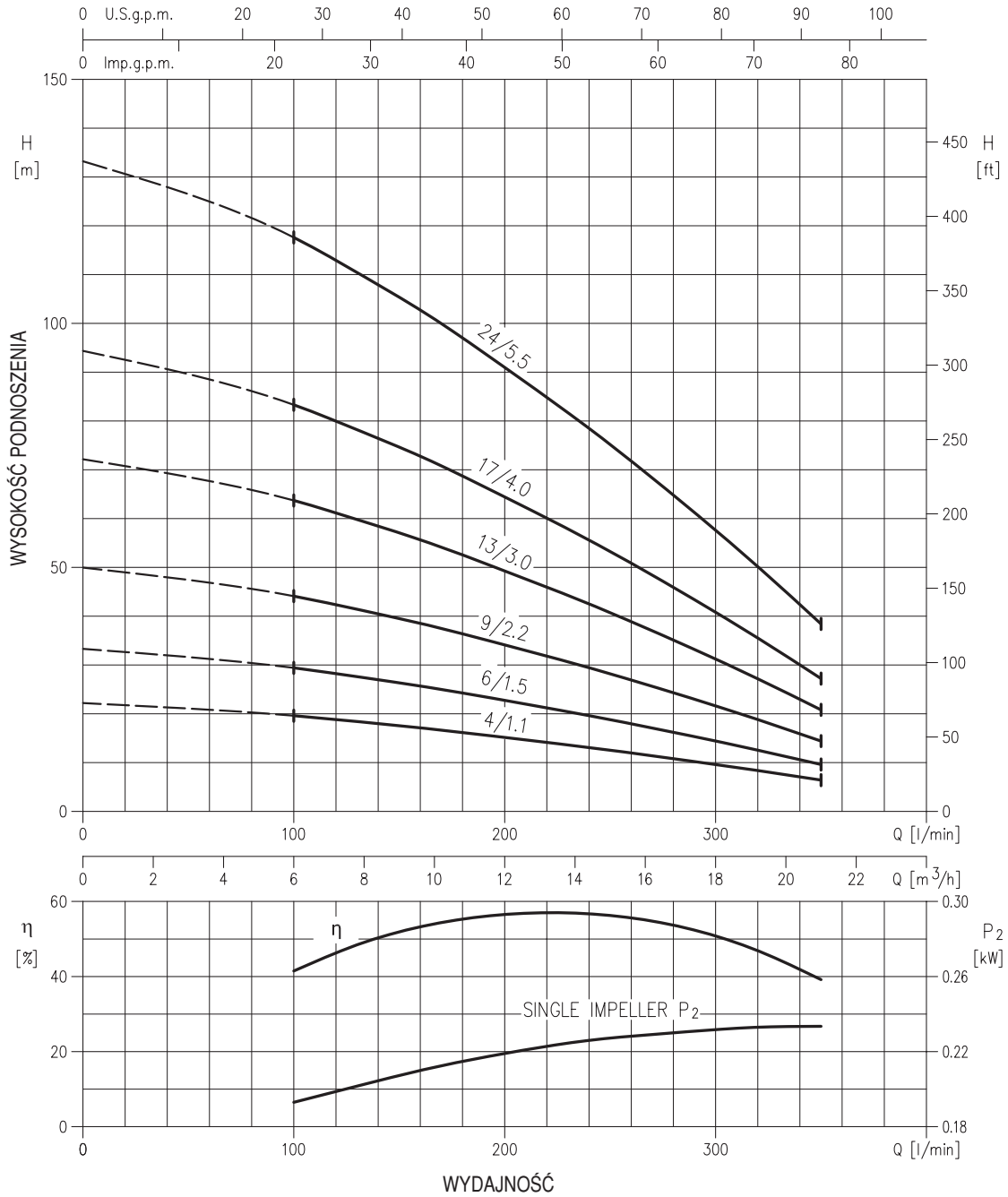



# WINNER 4N

POMPY GŁĘBINOWE DO STUDNI 4"

## ZAKRES STOSOWANIA (w/g ISO 9906 Aneks A)

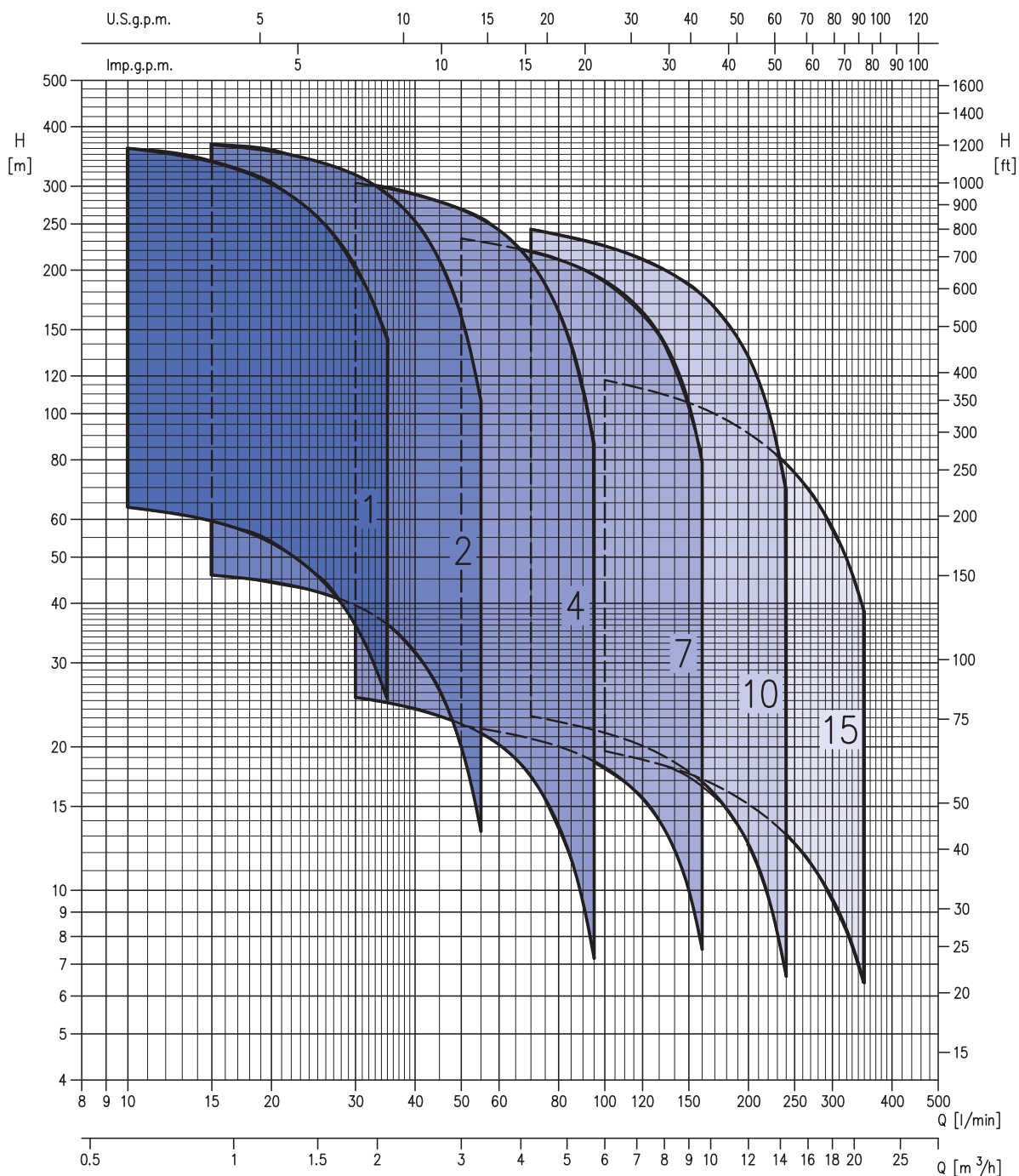



# WINNER 4N

## POMPY GŁĘBINOWE DO STUDNI 4"

**TABELA DANYCH**

Typ pompy	Silnik		Q=Wydajność											
	kW	HP	l/min	0	10	15	20	25	30	35	45	55	75	95
			m <sup>3</sup> /h	0	0,6	0,9	1,2	1,5	1,8	2,1	2,7	3,3	4,5	5,7
			H=Wysokość podnoszenia (m)											
4N1/12	0,37	0,5	67	64	60	54	46	36	25	-	-	-	-	
4N1/18	0,55	0,7	100	95	89	80	68	54	38	-	-	-	-	
4N1/24	0,75	1	133	127	119	107	91	72	50	-	-	-	-	
4N1/34	1,1	1,5	189	180	169	152	129	102	71	-	-	-	-	
4N1/48	1,5	2	266	254	238	214	182	144	101	-	-	-	-	
4N1/68	2,2	3	377	360	337	303	258	204	143	-	-	-	-	
4N2/7	0,37	0,5	49	-	46	44	42	40	36	26	13	-	-	
4N2/10	0,55	0,7	69	-	66	63	60	57	52	38	19	-	-	
4N2/14	0,75	1	97	-	92	89	85	79	72	53	27	-	-	
4N2/20	1,1	1,5	139	-	131	127	121	113	103	75	38	-	-	
4N2/28	1,5	2	194	-	183	178	169	158	144	105	53	-	-	
4N2/40	2,2	3	277	-	262	254	242	226	206	150	76	-	-	
4N2/56	3	4	388	-	367	355	338	317	289	210	106	-	-	
4N4/4	0,37	0,5	28	-	-	-	-	25	25	23	21	16	7	
4N4/7	0,55	0,7	49	-	-	-	-	44	43	41	37	27	13	
4N4/9	0,75	1	63	-	-	-	-	57	56	52	48	35	16	
4N4/13	1,1	1,5	90	-	-	-	-	83	80	75	69	51	23	
4N4/18	1,5	2	125	-	-	-	-	114	111	104	96	70	32	
4N4/27	2,2	3	188	-	-	-	-	171	167	157	144	105	49	
4N4/36	3	4	250	-	-	-	-	229	223	209	192	140	65	

Typ pomp	Silnik		Q=Wydajność											
	kW	HP	l/min	0	50	70	100	130	160	200	240	280	320	350
			m <sup>3</sup> /h	0	3,0	4,2	6,0	7,8	9,6	12,0	14,4	16,8	19,2	21,0
			H=Wysokość podnoszenia (m)											
4N7/4	0,55	0,7	25	22	21	18	14	8	-	-	-	-	-	
4N7/6	0,75	1,0	37	33	31	27	21	11	-	-	-	-	-	
4N7/8	1,10	1,5	50	44	42	36	28	15	-	-	-	-	-	
4N7/12	1,50	2,0	74	67	62	54	42	23	-	-	-	-	-	
4N7/17	2,20	3,0	105	94	88	77	60	32	-	-	-	-	-	
4N7/23	3,00	4,0	143	128	120	104	81	43	-	-	-	-	-	
4N7/30	4,00	5,5	186	167	156	136	105	56	-	-	-	-	-	
4N7/42	5,50	7,5	260	233	219	190	147	79	-	-	-	-	-	
4N10/4	0,75	1,0	26	-	23	21	19	17	13	7	-	-	-	
4N10/6	1,10	1,5	39	-	35	32	29	25	19	10	-	-	-	
4N10/8	1,50	2,0	52	-	46	43	39	34	25	13	-	-	-	
4N10/12	2,20	3,0	78	-	70	64	58	51	38	20	-	-	-	
4N10/17	3,00	4,0	111	-	99	91	82	72	53	28	-	-	-	
4N10/23	4,00	5,5	150	-	133	123	111	97	72	38	-	-	-	
4N10/30	5,50	7,5	195	-	174	161	145	127	94	50	-	-	-	
4N10/42	7,50	10,0	273	-	244	225	203	177	131	69	-	-	-	
4N15/4	1,10	1,5	22	-	-	20	18	17	15	13	11	8	6	
4N15/6	1,50	2,0	33	-	-	29	28	26	23	20	16	13	10	
4N15/9	2,20	3,0	50	-	-	44	41	39	34	29	24	19	14	
4N15/13	3,00	4,0	72	-	-	64	60	56	49	43	35	27	21	
4N17/17	4,00	5,5	94	-	-	83	78	73	64	56	46	36	27	
4N15/24	5,50	7,5	133	-	-	118	110	103	91	78	65	50	38	