

SRD

Pompy specjalistyczne procesowe z wirnikiem zamkniętym



PRZEZNACZENIE

Pompy SRD to pompy wirowe jednostopniowe wyposażone w wirnik zamknięty. Przeznaczone są do pompowania cieczy lekko zanieczyszczonych i zanieczyszczonych.

Wyposażone mogą one być w jedno z wielu rodzajów uszczelnień mechanicznych albo sznurowych, co pozwala je stosować również w trudnych technologicznie przypadkach, jak praca ze ssaniem, w wysokich temperaturach itd.

Część hydrauliczna jest wykonana ze staliwa kwasoodpornego AISI316, co czyni pompę odporną chemicznie na większość mediów. Typoszereg pomp pokrywa bardzo gęsto pole pracy Q-H, co pozwala na precyzyjny, uzasadniony techniczno-ekonomicznymi kryteriami dobór wielkości pompy i jej silnika.

Oczywiście pompować pompami SRD można cieczy o zwiększonej lepkości i gęstości, co poparte musi być doбором silnika o zwiększonej mocy.

Pompy SRD stosować należy w zakresie niskich i średnich wydajności Q oraz umiarkowanych i znacznych wysokości podnoszenia H.

Mogą być stosowane we wszystkich gałęziach przemysłu.

ZAKRES UŻYTKOWANIA

Wydajność	do 300 m ³ /h
Wysokość podnoszenia	do 140 m
Ciśnienie robocze	do 1,6 MPa
Średnica przyłączy	32 do 150 DN
Moc silnika	do 160 kW
Temperatura czynnika	-20 do 200°C

CECHY KONSTRUKCYJNE

część hydrauliczna

- pompa wirowa jednostopniowa,
- wirnik zamknięty,
- uszczelnienie dławnicą mechaniczną lub sznurową,
- wykonanie ze staliwa kwasoodpornego,
- zróżnicowane wykonanie:
 - z wolnym końcem wału SRD A,
 - na płycie podstawy z silnikiem i sprzęgłem krótkim SRD K,
 - na płycie podstawy z silnikiem i sprzęgłem demontowalnym SRD D,
 - wspornikowe SRD L,
 - wspornikowe na płycie podstawy SRD P,
 - monoblokowe SRD M

silnik

- 2, 4 lub 6-biegunowy,
- silniki w klasie sprawności IE2 lub IE3,
- standardowo napięcie 3x400-415V, 50Hz,
- kierunek obrotów w prawo (patrzac od strony przewietrznika)
- stopień ochrony IP55.

ZALETY

- znormalizowane wymiary,
- modułowa budowa,
- niskie koszty wytworzenia,
- krótkie terminy realizacji,
- możliwość współpracy z przetwornicą zewnętrzną,
- duża niezawodność,
- rozbudowany typoszereg,
- wysokie sprawności i niskie NPSH,
- możliwość nietypowego zasilania np. 3x500V, 60Hz,
- dostępność i szybkość serwisowania,
- dostępność wykonan przeciwwybuchowych zgodnie z ATEX.

POMPY SPECJALISTYCZNE

KLUCZ OZNACZEŃ

	SR	D	D	100	-	20	A	C	122	.3	75	/	2900	XX
Oznaczenie typoszeregu	_____													
Typ wirnika - D - zamknięty	_____													
Rodzaj budowy - A - z wolnym końcem wału - K - na płycie podstawy z silnikiem i sprzęgłem krótkim - D - na płycie podstawy z silnikiem i sprzęgłem demontowalnym - L - wspornikowe - P - wspornikowe na płycie podstawy - M - monoblok	_____													
Średnica króćca tłoczego	_____													
Wielkość pompy	_____													
Wielkość wirnika	_____													
System uszczelnienia: - H - sznurowe - S - sznurowe z zewnętrznym płukaniem - U - mechaniczne pojedyncze - L - mechaniczne podwójne tandem - A - mechaniczne z komorą grzewczą/chłodzącą - C - mechaniczne podwójne back to back	_____													
Kod materiału uszczelnienia	_____													
Wykonanie materiałowe - bez oznaczenia - żeliwo - 3 - ANSI316	_____													
Moc silnika [kW]	_____													
Obroty silnika - 2900 min ⁻¹ - 1450 min ⁻¹ - 950 min ⁻¹	_____													
Inne dodatkowe dane	_____													

Opis	Jednostka miary	Typ pompy																					
		32-16	40-16	50-16	32-20	40-20	50-20	65-16	80-16	65-20	80-20	50-25	65-25	80-25	100-20	100-25	125-25	65-31	80-31	100-31	125-31	100-40	125-40
Wielkość korpusu łożyskowego		25						35						50									
Korpus																							
Grubość ścianki korpusu	mm	7	7,5	8	7,5	7,5	8	8,5	9	9	9,5	9	9,5	10	10	11	12,5	12	11,5	12	12,5	14	14
Otwór pod manometr		G.1/4						G.1/4						G.1/2									
Otwór spustowy		G.1/4						G.3/8						G.1/2									
Wirnik																							
Ilość łopatek		5	5	6	5	5	5	6	6	6	6	5	6	7	7	6	6	5	6	6	6	6	6
Szerokość wirnika	mm	6	8,5	13,5	6	7	11	19	27	16	21	8	13	16	27	23	32	11	14	18	26	16	20
Średnica wlotowa	mm	56	67	83	85	68	82	102	116	102	120	83	105	122	141	142	160	114	128	142	159	140	159
Maksymalna średnica wirnika	mm	169	169	169	209	209	209	169	169	209	209	259	259	259	209	259	259	319	319	319	319	409	409
Minimalna średnica wirnika	mm	110	110	110	140	140	140	130	140	160	150	180	170	170	160	160	180	260	210	220	240	250	250
Moment bezwładności *	kgm ²	8,3	8,6	9,0	16,8	17,4	17,9	11,5	12,2	23	21,8	38,8	50	49,7	26,8	66	68	144	138	142	158	430	425
Komora dławnicy sznurowej																							
Średnica	mm	55						68						80									
Głębokość	mm	74						86						92									
Średnica tulejki ochronnej wałka	mm	33						43						53									
Przekrój szczeliwa	mm	10						12						12									
Ilość pierścieni płuczających		4						4						4									
Ilość pierścieni niepłuczających		6						6						6									
Średnica uszczelnienia mechanicznego	mm	33						43						53									
Otworki przyłączeniowe hydr. do dław. sznurowej		G.1/4						G.1/4						G.1/4									
Otworki przyłączeniowe hydr. do dław. mech.		G.1/4						G.1/4						G.1/4									
Płaszcz chłodzący																							
Maksymalne ciśnienie	bar	3						3						3									
Maksymalne ciśnienie hydrostatyczne	bar	4,5						4,5						4,5									
Otworki przyłączeniowe hydrauliczne		G.1/4						G.1/4						G.1/4									
Wałek																							
Średnica wałka pod tulejką ochronną	mm	25						35						45									
Średnica wałka pod wirnikiem	mm	20						28						38									
Korpus łożyskowy																							
Maksymalna wartość P/n		0,008						0,022						0,045									
Maksymalna moc przy n=960min ⁻¹	kW	7,7						21						43									
Maksymalna moc przy n=1450min ⁻¹	kW	11,5						32						65									
Maksymalna moc przy n=2900min ⁻¹	kW	23						64						130									
Łożysko standardowe																							
Strona pompy		6305						6307						6310									
Strona silnika (napędu)		6305						3307						3310									
Łożysko do pracy ciężkiej 1																							
Strona pompy		6305 **						NJ 307						NJ 310									
Strona silnika (napędu)		3305 **						2x7307						2x7310									
Łożysko do pracy ciężkiej 2																							
Strona pompy		NJ 305						-						-									
Strona silnika (napędu)		2x7305						-						-									

Dane techniczne są orientacyjne i mogą ulec zmianie podczas pracy pompy.

*/ aby otrzymać moment bezwładnościowy J [kgm2] należy podzielić przez 1000.

**/ na specjalne zamówienie.

POMPY SPECJALISTYCZNE

Ograniczenia ciśnienia i temperatury

(bez szczególnych wymagań)

Odpowiednie dla każdego rodzaju cieczy, oprócz gorącej wody i organicznych olejów przenoszących ciepło.

Wykonanie materiałowe:

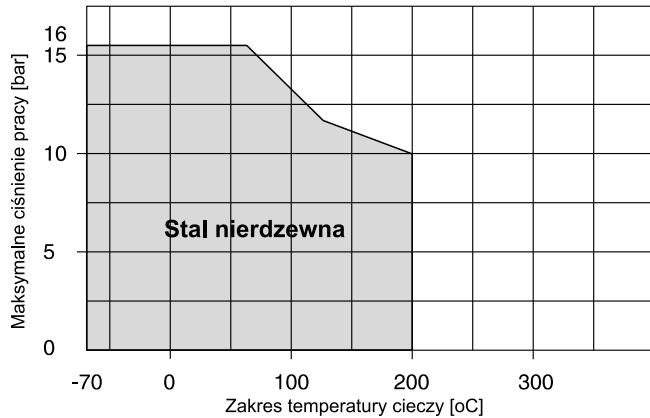

Wyk. materiałowe	Temperatura	Ciśnienie
stal nierdzewna	-20 +120	16 Bar
stal nierdzewna	+120 +200	12 Bar

Wykonanie materiałowe na życzenie : Sanicro, SAF, CF3M, Hastelloy

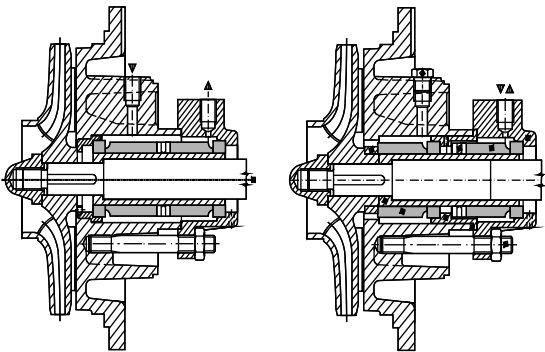

Uszczelnienie typu C

Uszczelnienie typu L

Płukanie podwójnego uszczelnienia mechanicznego dla wykonania C i L.

Wielkość korpusu łożyskowego [mm]	Średnica uszczelnienia mechanicznego [mm]	Wydajność płukania (przepływu) [l/min]		Ciśnienie przepływu [bar]	
		2900 rpm	1450 rpm	C	L
25	33	1,4	0,7	0,5 > ciśnienia na tloczeniu pompy	< 0,3
35	43	2	1		
50	53	3	1,5		

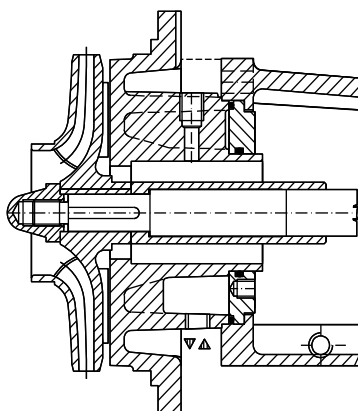

Uszczelnienie typu H

Płukanie komory chłodzącej dla wykonania H

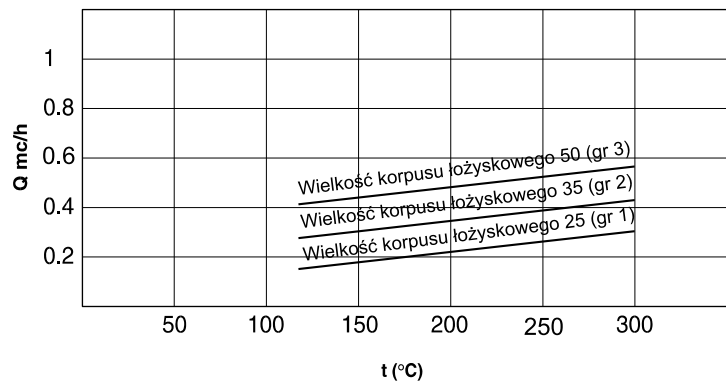

BUDOWA

Budowa pomp z wolną końcówką wału SRD A

Pompy SRD A 32-16, SRD A 32-20, SRD A 40-16, SRD A 40-20, SRD A 50-16, SRC A 50-20

Pompy
SRD A 50-25,
SRD A 65-16,
SRD A 65-20,
SRD A 65-25,
SRD A 80-16,
SRD A 80-20,
SRD A 80-25,
SRD A 100-20,

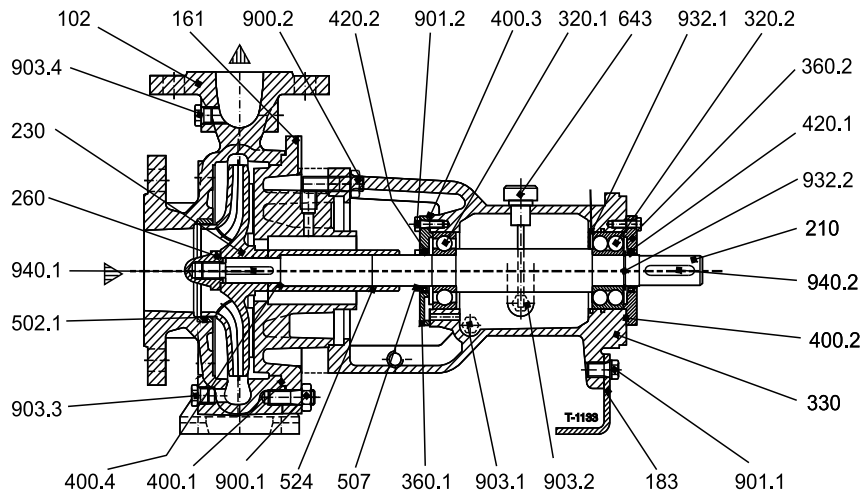
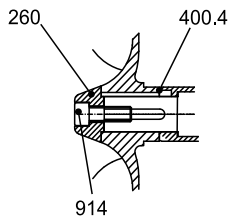

Pompy SRD A 65-31, SRD A 80-31, SRD A 100-25, SRD A 100-31, SRD A 100-40, SRD A 125-25, SRD A 125-31, SRD A 125-40

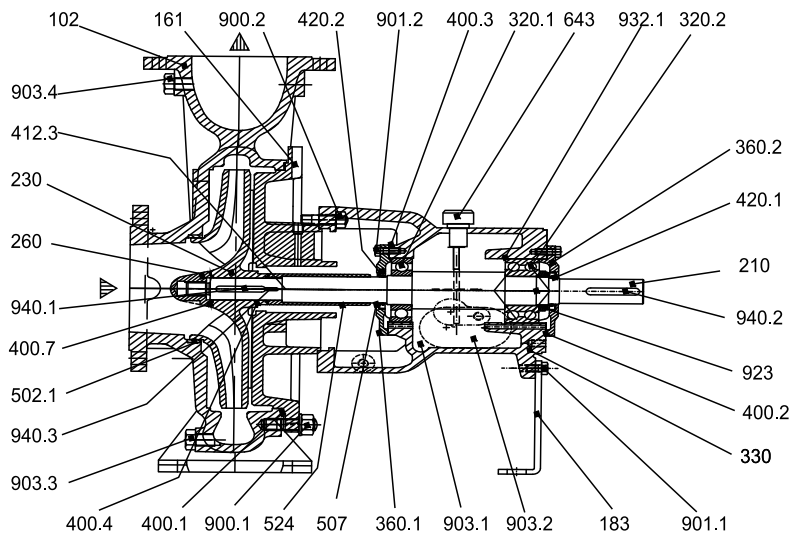

102	korpus	412,3	o-ring tulejki ochronnej
161	pokrywa	507	v-ring
183	wspornik	524	tulejka ochronna
210	wał pompy	643	bagnet oleju
230	wirnik	900,1	śruba dwustronna z nakrętką
260	nakrętka lub podkładka wirnika	900,2	śruba dwustronna z nakrętką
320,1	łożysko kulkowe (od strony pompy)	901,1	śruba z łbem sześciokątnym
320,2	łożysko kulkowe (od strony napędu)	901,2	śruba z łbem sześciokątnym
330	korpus łożyskowy	903,1	korek spustowy oleju
360,1	pokrywa łożyska (od strony pompy)	903,2	korek poziomy oleju
360,2	pokrywa łożyska (od strony napędu)	903,3	korek stustowy
400,1	uszczelka pokrywy	903,4	korek pod manometr
400,2	uszczelka pokrywy łożyska (od strony napędu)	914	śruba
400,3	uszczelka pokrywy łożyska (od strony pompy)	923	nakrętka łożyska
400,4	uszczelka tulejki ochronnej	932,1	pierścień osadczy
400,7	uszczelka nakrętki wirnika	932,2	pierścień zewnętrzny
420,1	uszczelnienie pokrywy korpusu (od strony napędu)	940,1	wpust wirnika
420,2	uszczelnienie pokrywy korpusu (od strony pompy)	940,2	wpust sprzęgła
502,1	pierścień labiryntu	940,3	wpust tulejki ochronnej

POMPY SPECJALISTYCZNE

Budowa pomp wspornikowych SRD L

Pompy SRD L 32-16, SRD L 32-20, SRD L 40-16, SRD L 40-20, SRD L 50-16, SRD L 50-20

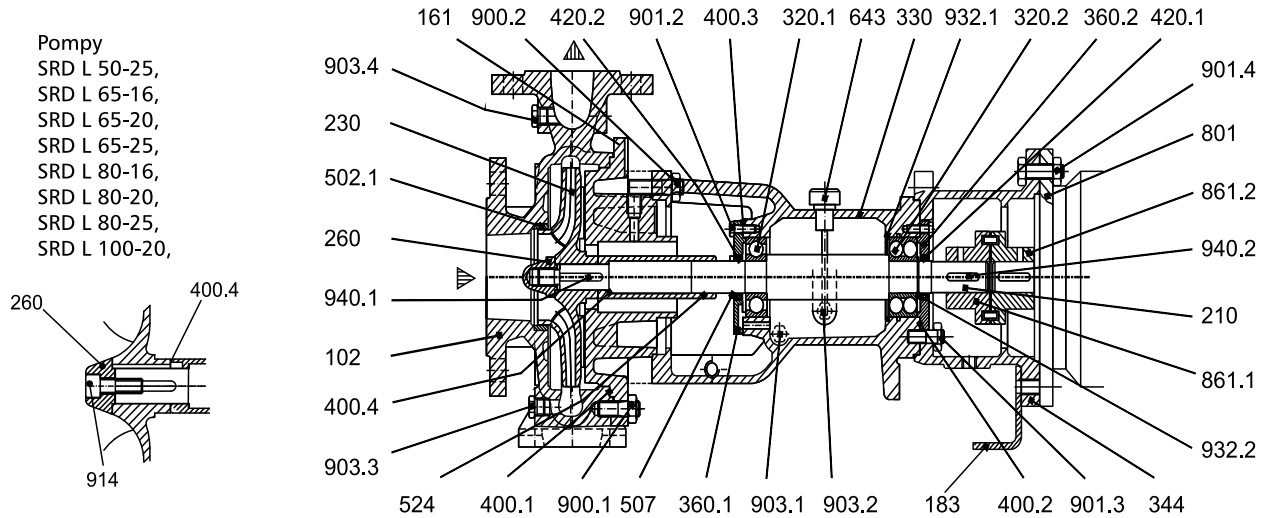

Pompy SRD L 65-31, SRD L 80-31, SRD L 100-25, SRD L 100-31, SRD L 100-40, SRD L 125-25, SRD L 125-31, SRD L 125-40

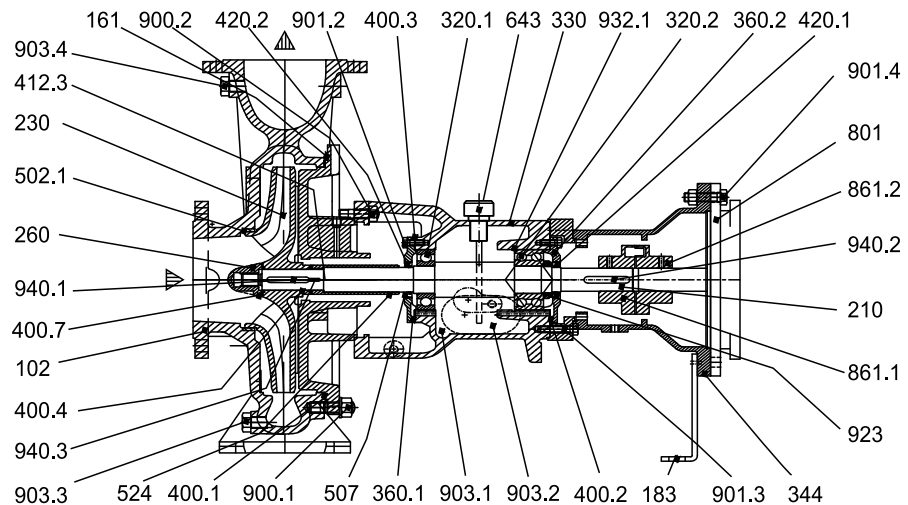

102	korpus	643	bagnet oleju
161	pokrywa	801	silnik elektryczny
183	wspornik	861,1	pólsprężło (od strony pompy)
210	wał pompy	861,2	pólsprężło (od strony napędu)
230	wirnik	900,1	śruba dwustronna z nakrętką
260	nakrętka lub podkładka wirnika	900,2	śruba dwustronna z nakrętką
320,1	łożysko kulkowe (od strony pompy)	901,1	śruba z łbem sześciokątnym
320,2	łożysko kulkowe (od strony napędu)	901,2	śruba z łbem sześciokątnym
330	korpus łożyskowy	901,3	śruba z łbem sześciokątnym
344	łącznik	901,4	śruba z łbem sześciokątnym
360,1	pokrywa łożyska (od strony pompy)	903,1	korek spustowy oleju
360,2	pokrywa łożyska (od strony napędu)	903,2	korek poziomy oleju
400,1	uszczelka pokrywy	903,3	korek stustowy
400,2	uszczelka pokrywki łożyska (od strony napędu)	903,4	korek pod manometr
400,3	uszczelka pokrywki łożyska (od strony pompy)	914	śruba
400,4	uszczelka tulejki ochronnej	923	nakrętka łożyska
400,7	uszczelka nakrętki wirnika	932,1	pierścień osadczy
412,3	o-ring tulejki ochronnej	932,2	pierścień zewnętrzny
420,1	uszczelnienie pokrywki korpusu (od strony napędu)	940,1	wpust wirnika
420,2	uszczelnienie pokrywki korpusu (od strony pompy)	940,2	wpust sprzęgła
502,1	pierścień labiryntu	940,3	wpust tulejki ochronnej
507	v-ring		

Budowa pomp monoblokowych SRD M

Pompy SRD M 32-16, SRD M 32-20, SRD M 40-16, SRD M 40-20, SRD M 50-16, SRD M 50-20, SRD M 50-25, SRD M 65-16, SRD M 65-20, SRD M. 65-25, SRD M 80-16, SRD M 80-20, SRD M 80-25

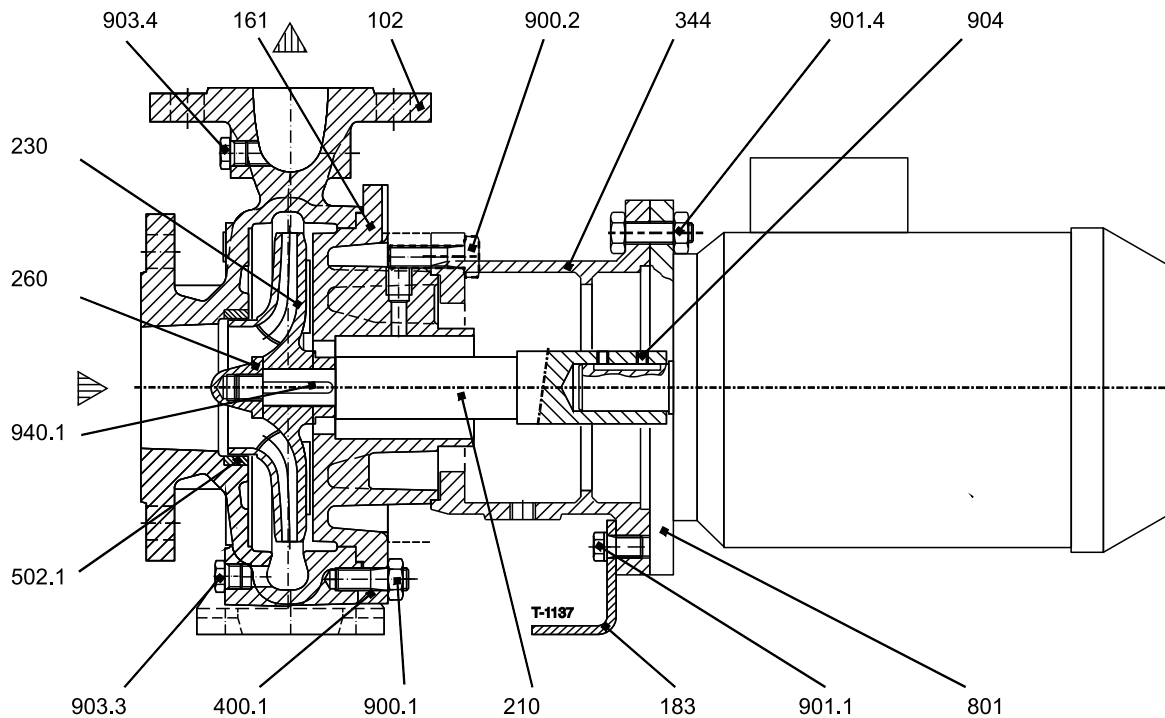

- | | |
|-------|----------------------------|
| 102 | korpus |
| 161 | pokrywa |
| 183 | wspornik |
| 210 | wał pompy |
| 230 | wirnik |
| 260 | nakrętka wirnika |
| 344 | łącznik |
| 400,1 | uszczelka korpusu |
| 502,1 | pierścień labiryntu |
| 801 | silnik elektryczny |
| 900,1 | śruba dwustronna z nakrętą |
| 900,2 | śruba dwustronna z nakrętą |
| 901,1 | śruba z łbem sześciokątnym |
| 901,4 | śruba z łbem sześciokątnym |
| 903,3 | korek spustowy |
| 903,4 | korek pod manometr |
| 904 | śruba dociskowa |
| 940,1 | wpust wirnika |

POMPY SPECJALISTYCZNE

USZCZELNIENIA - DŁAWNICE

Uszczelnienie typu H
sznurowe

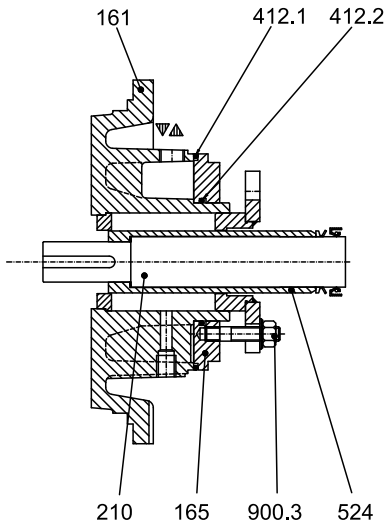

Uszczelnienie typu S
sznurowe z zewnętrznym płukaniem

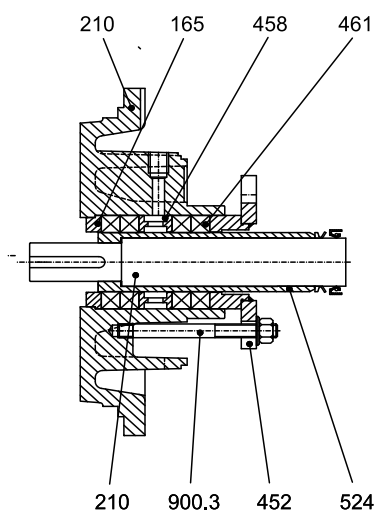

Uszczelnienie typu U
mechaniczne pojedyncze

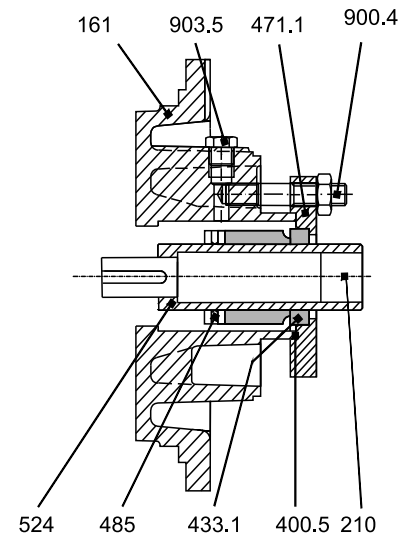

Uszczelnienie typu A
mechaniczne
z komorą grzewczą/chłodzącą

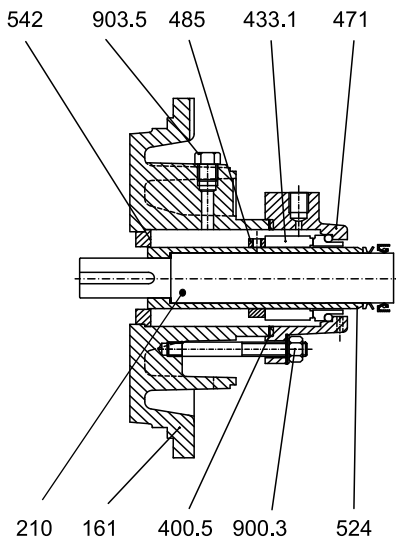

Uszczelnienie typu C
mechaniczne podwójne
back to back

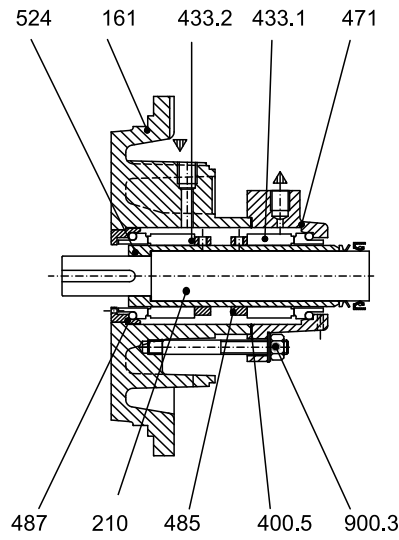

Uszczelnienie typu L
mechaniczne podwójne
szeregowe (tandem)

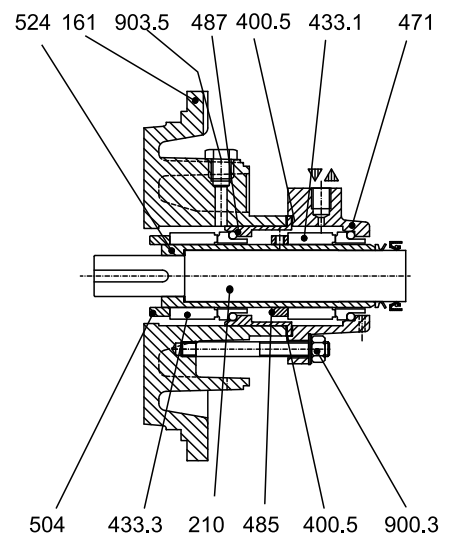

161 pokrywa pompy
165 pokrywa uszczelniająca
210 wałek
400,5 uszczelka płaska
412,1 o-ring
412,2 o-ring
433,1 uszczelnienie mechaniczne
433,2 uszczelnienie mechaniczne
433,3 uszczelnienie mechaniczne
452 dławik
458 pierścień płuczący

461 krążek szczeliwa
471 pokrywa dławnicy mechanicznej
471,1 pokrywa dławnicy mechanicznej
485 pierścień oporowy
487 uszczelnienie pierścienia stałego
504 pierścień dystansowy
524 tulejka ochronna
542 pierścień oporowy
900,3 śruba dwustronna z nakrętką
900,4 śruba dwustronna z nakrętką
903,5 korek

CHARAKTERYSTYKI POMP

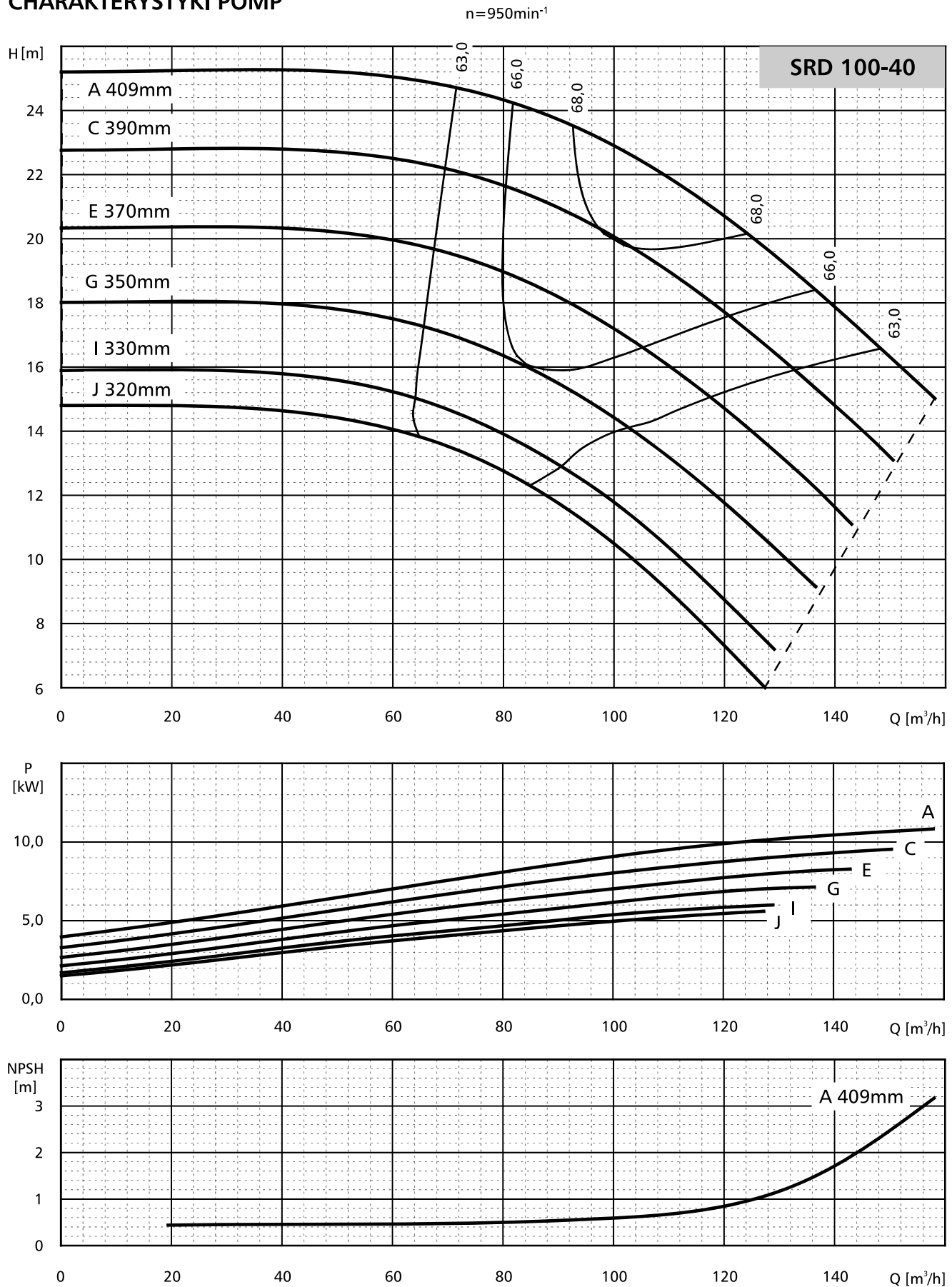

POMPY SPECJALISTYCZNE

$n=950\text{min}^{-1}$

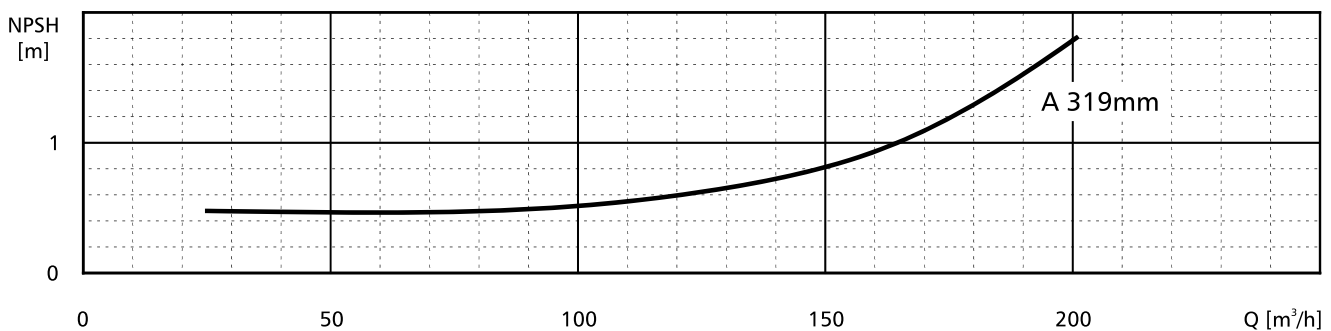
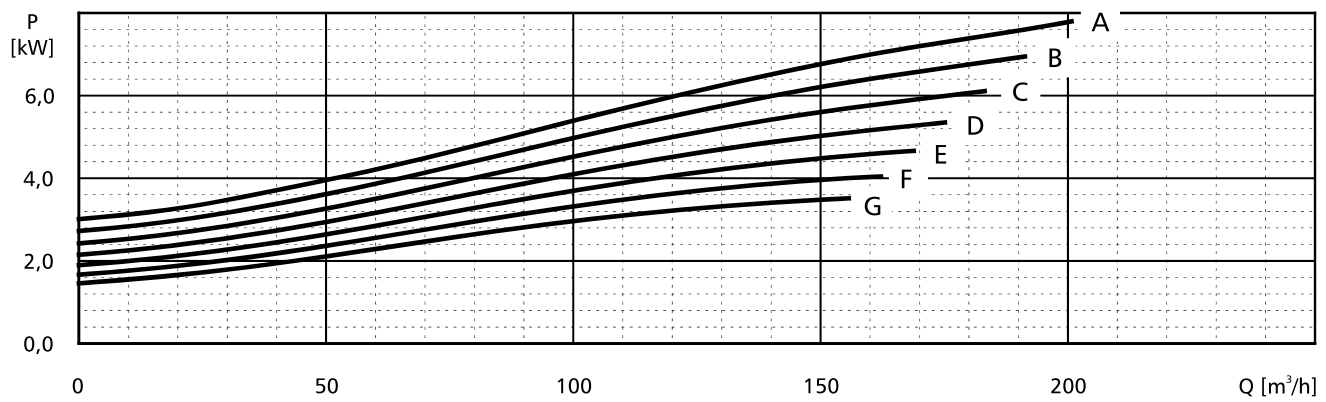
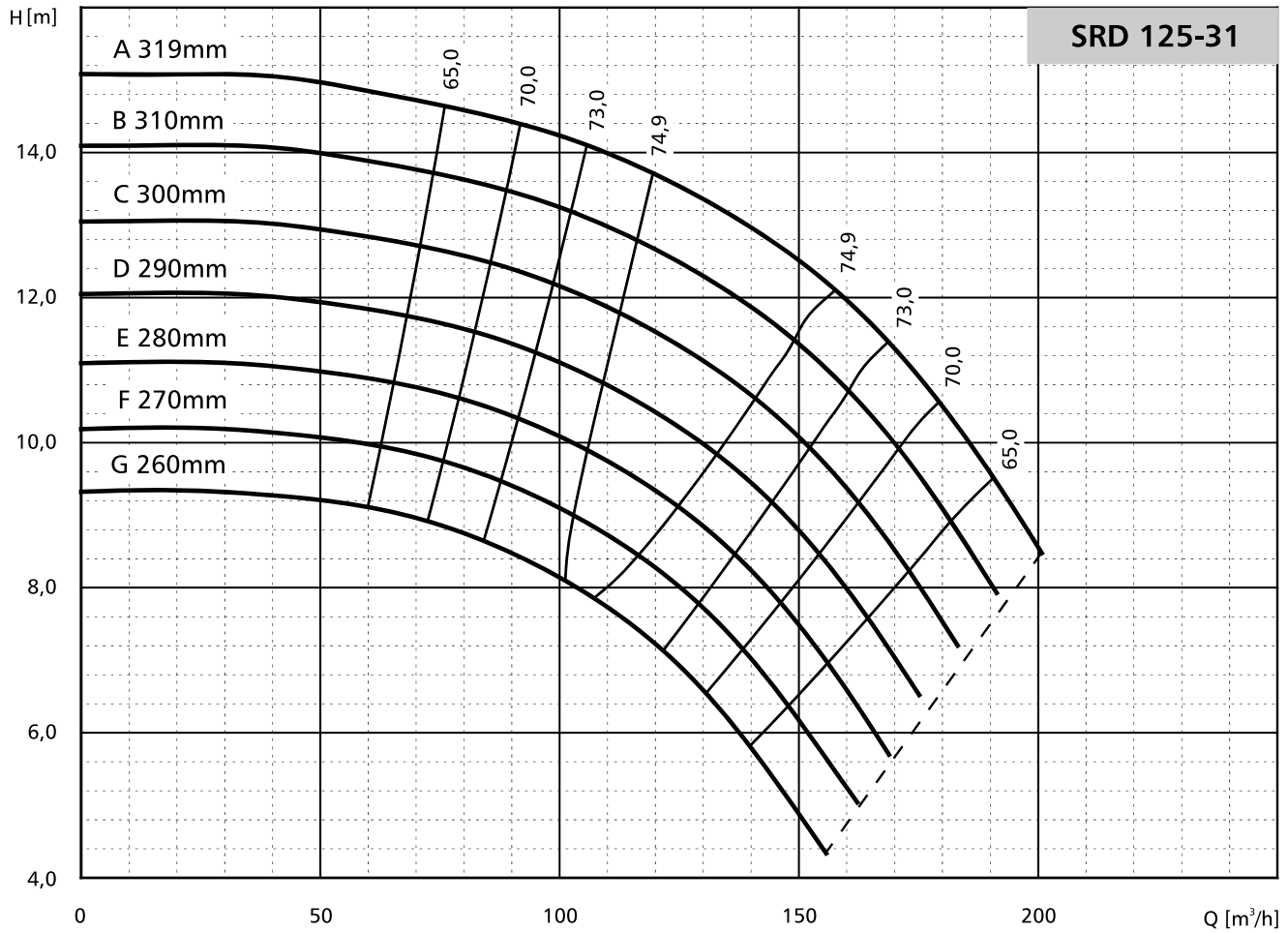

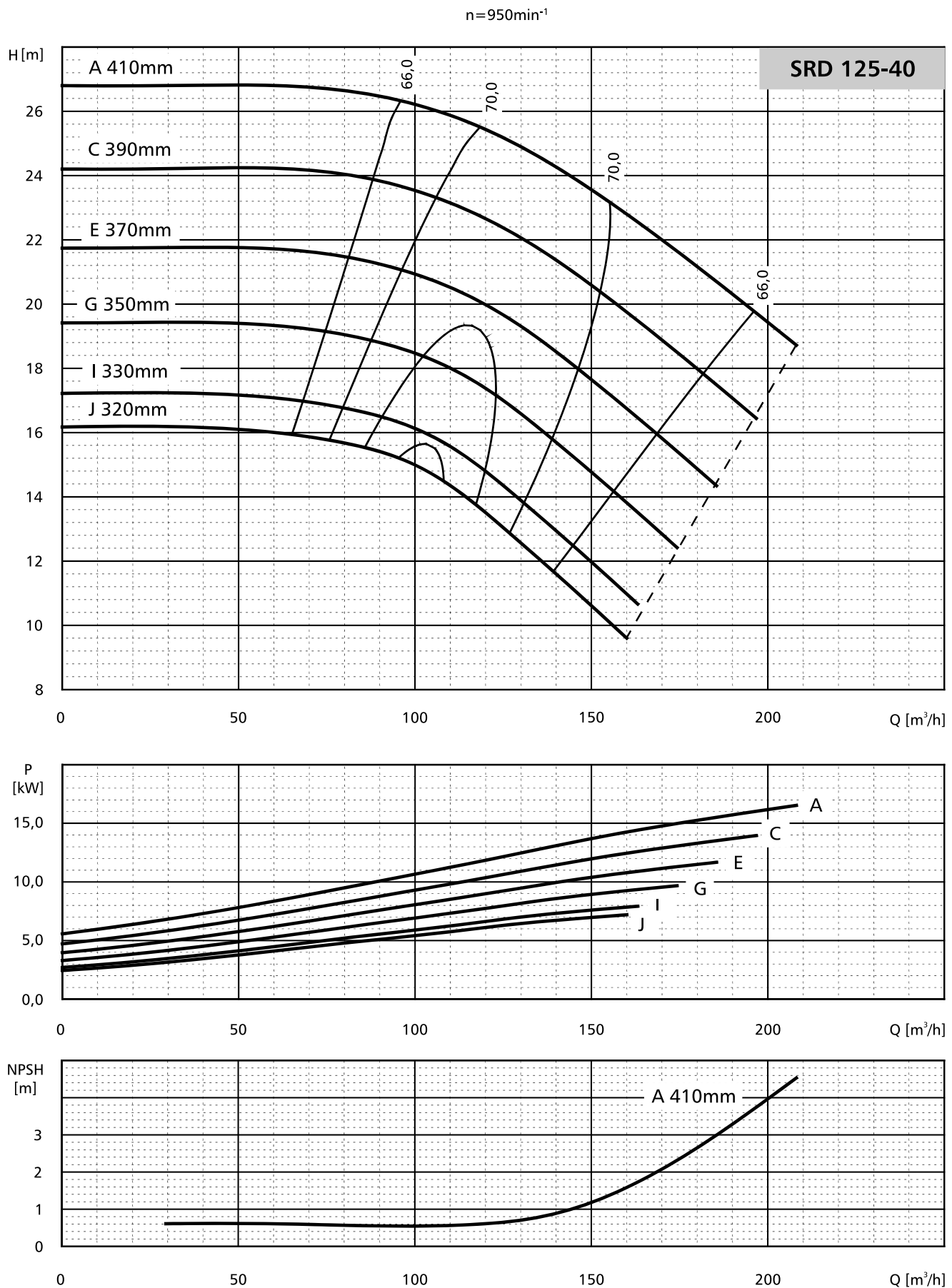

$n=1450\text{min}^{-1}$

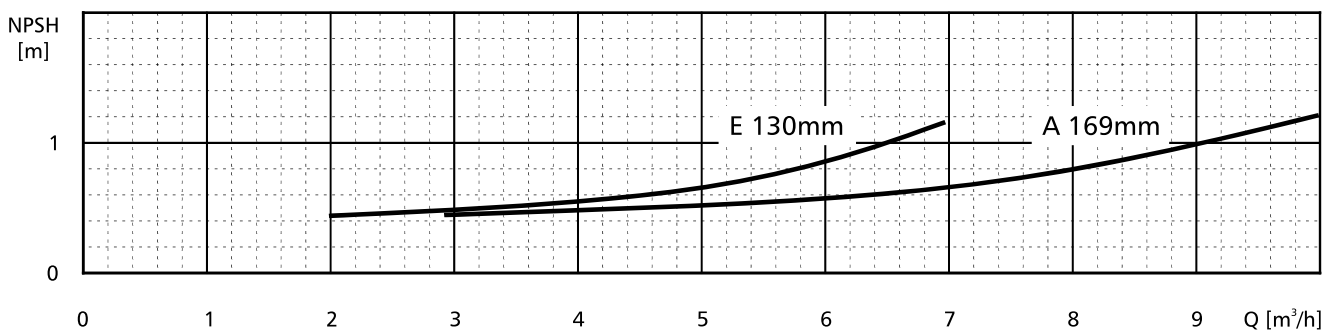
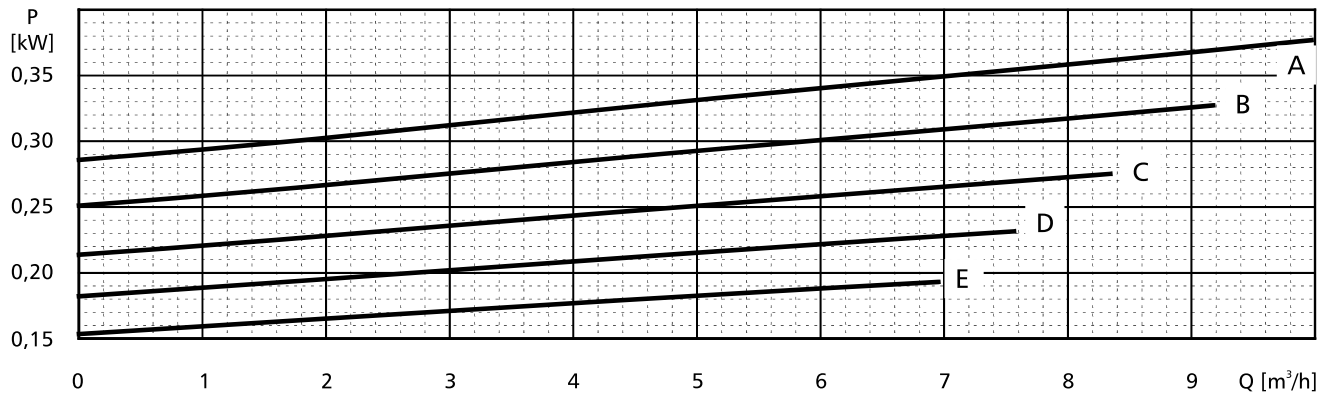
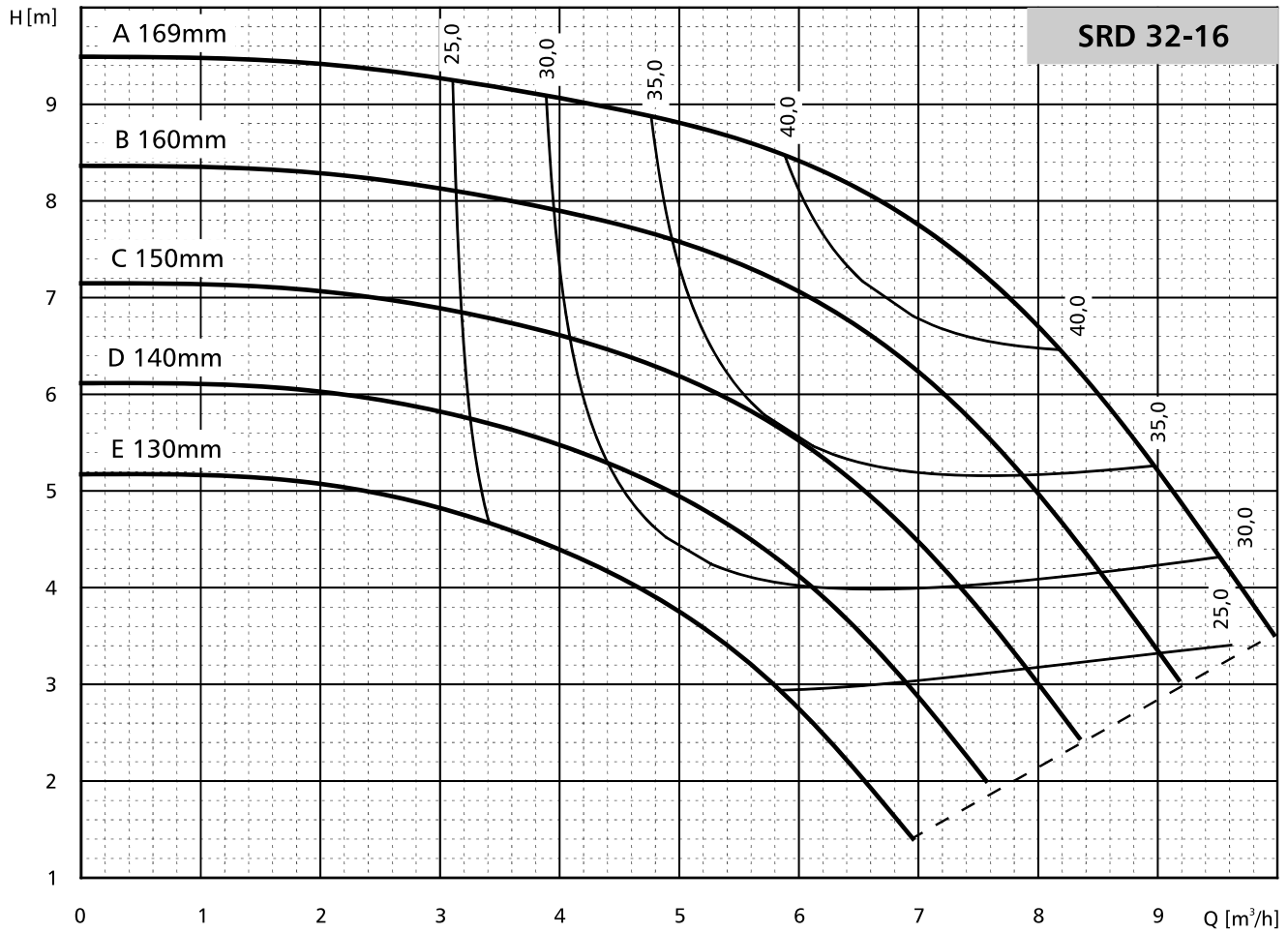

$n=1450\text{min}^{-1}$

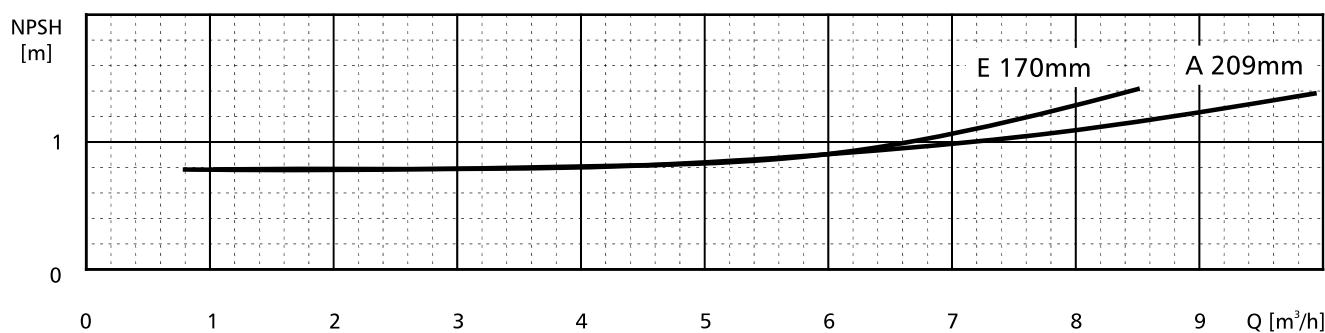
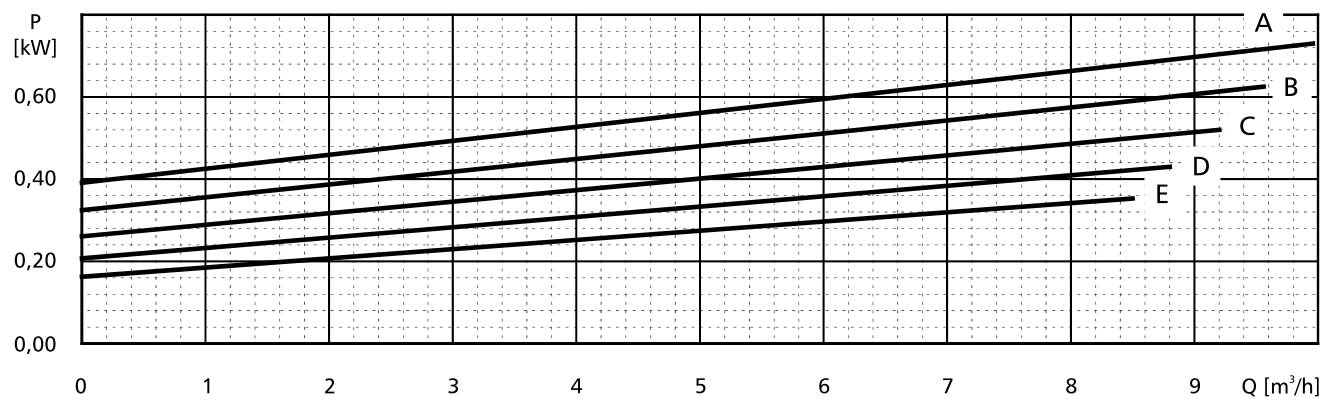
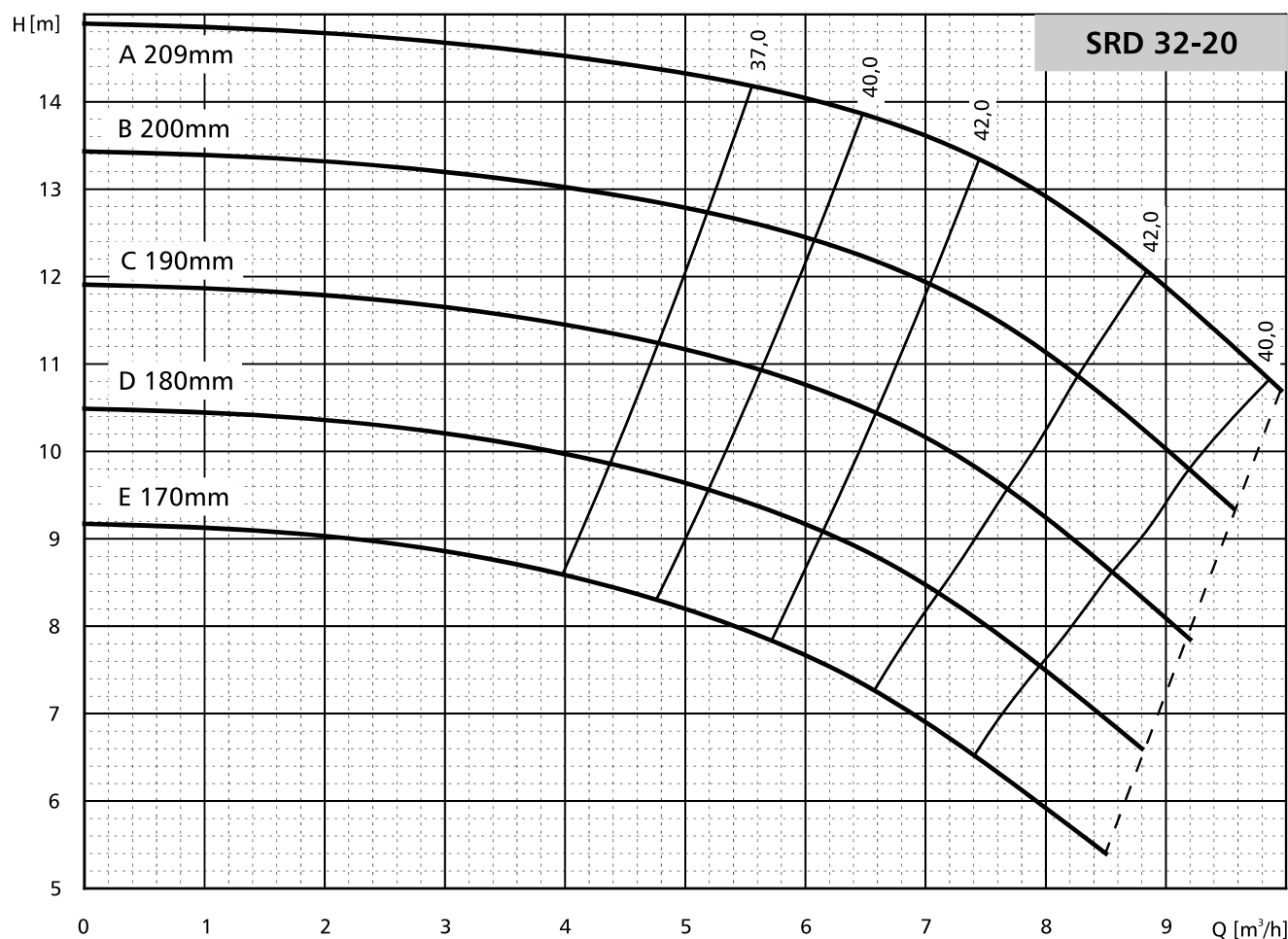

$n=1450\text{min}^{-1}$

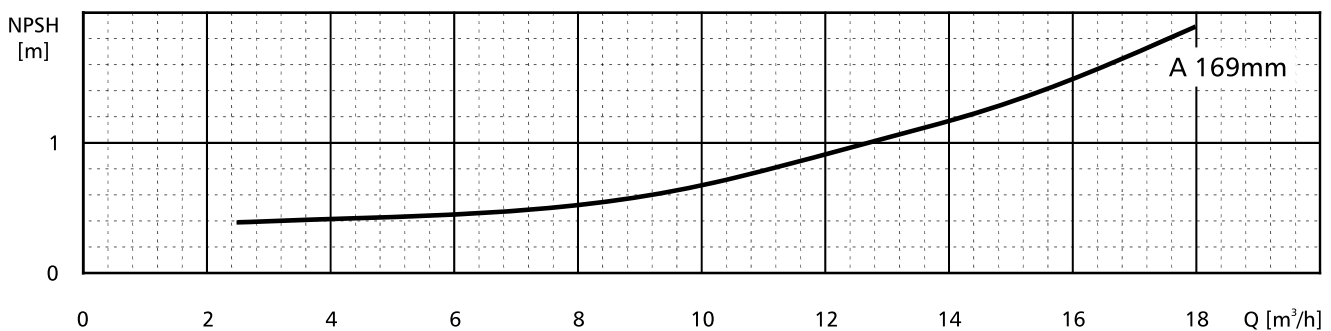
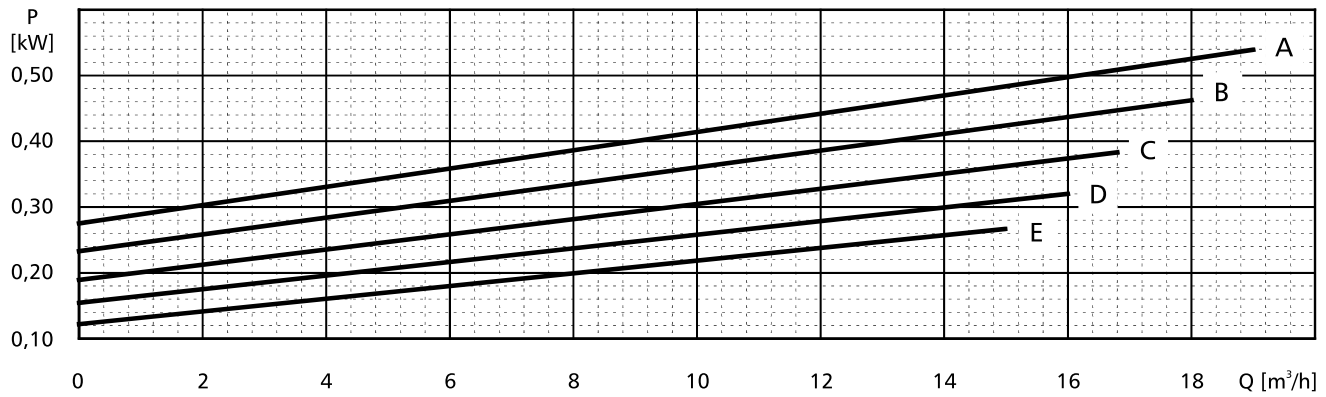
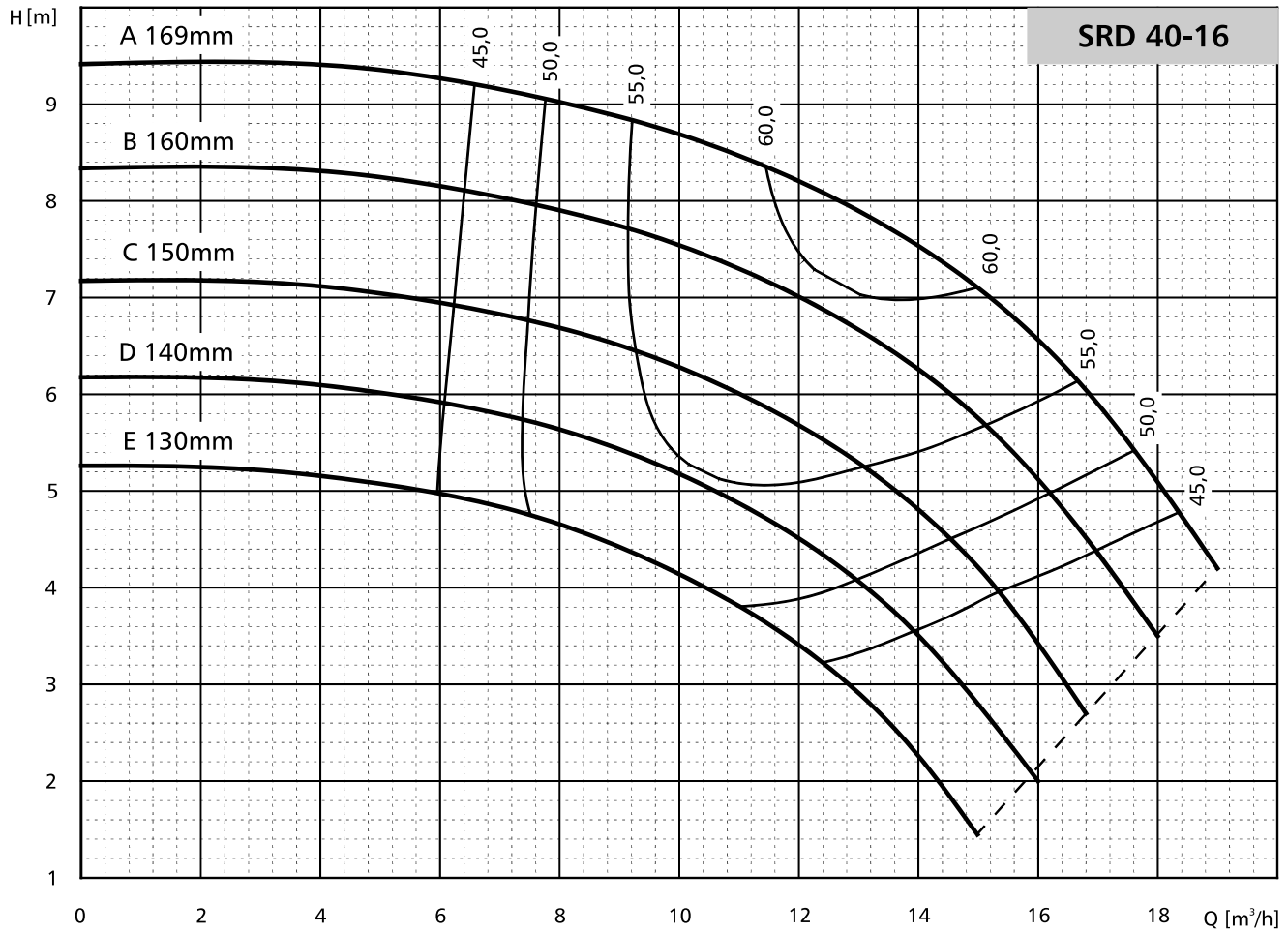

$n = 1450 \text{ min}^{-1}$

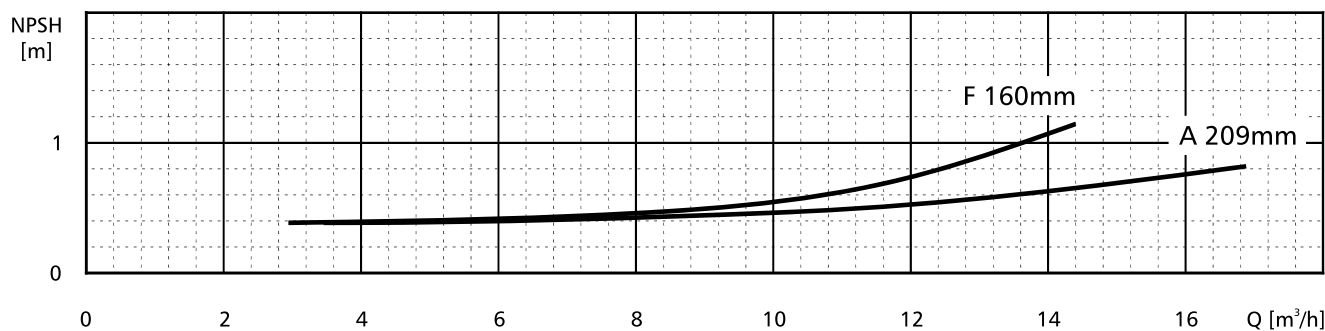
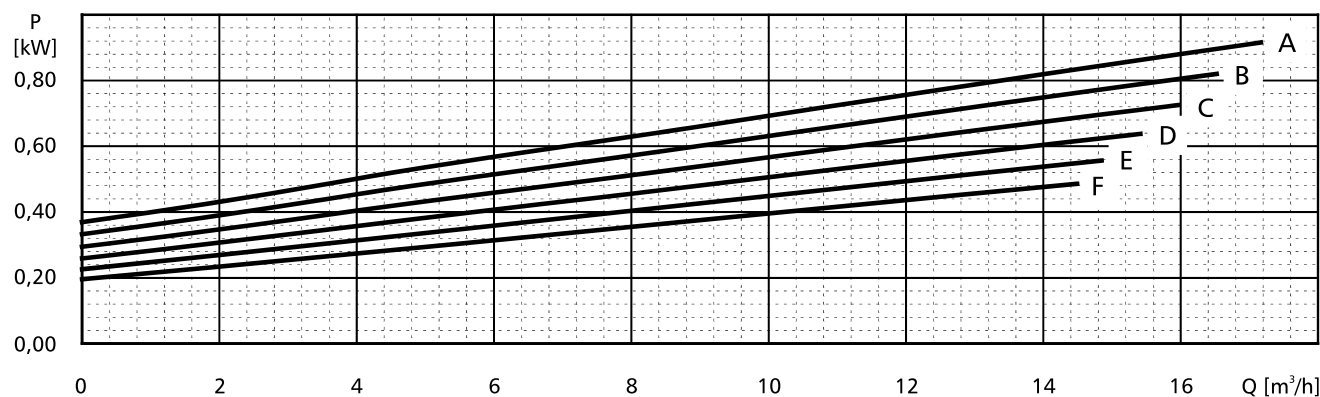
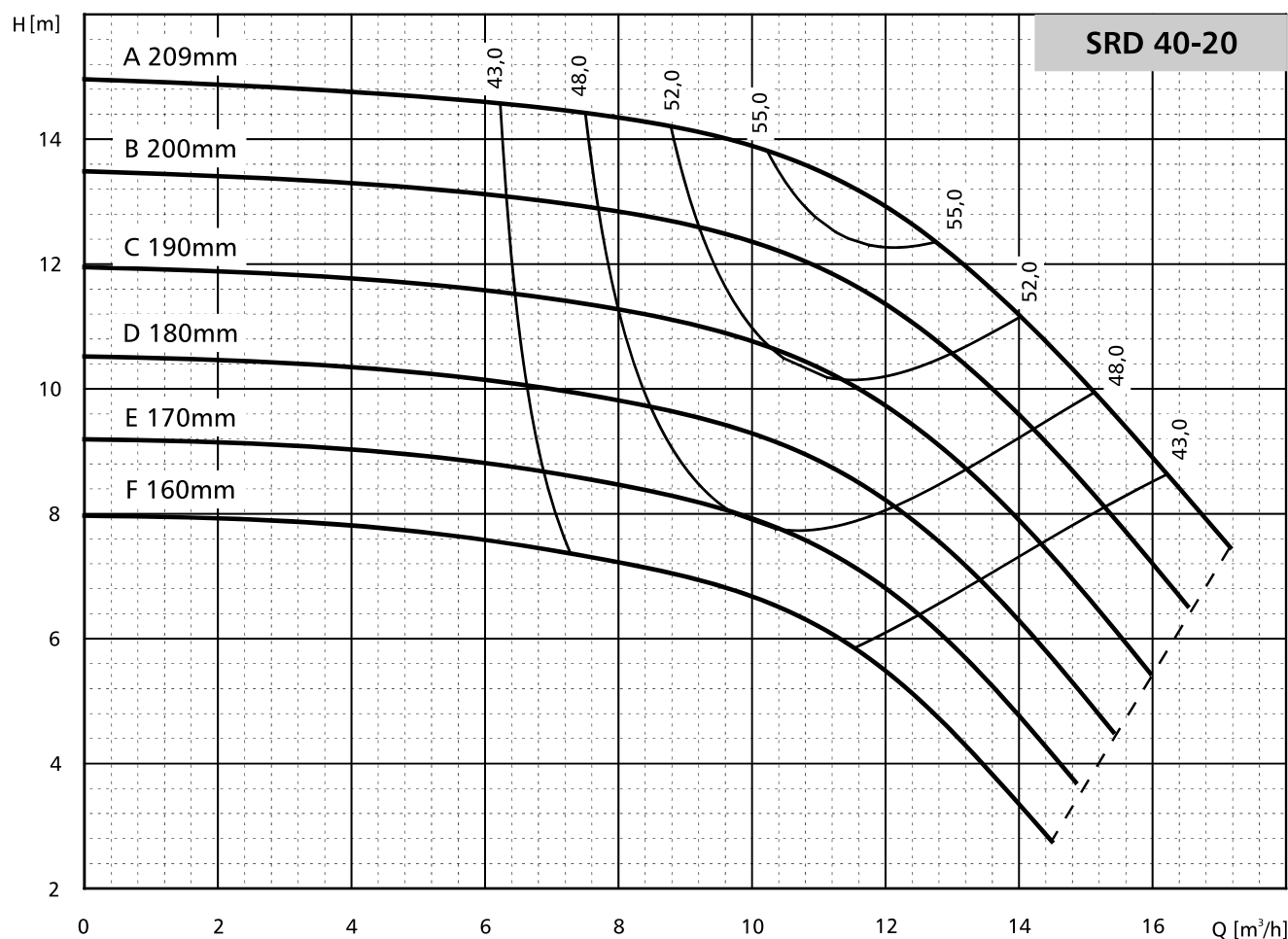

POMPY SPECJALISTYCZNE

$n=1450\text{min}^{-1}$

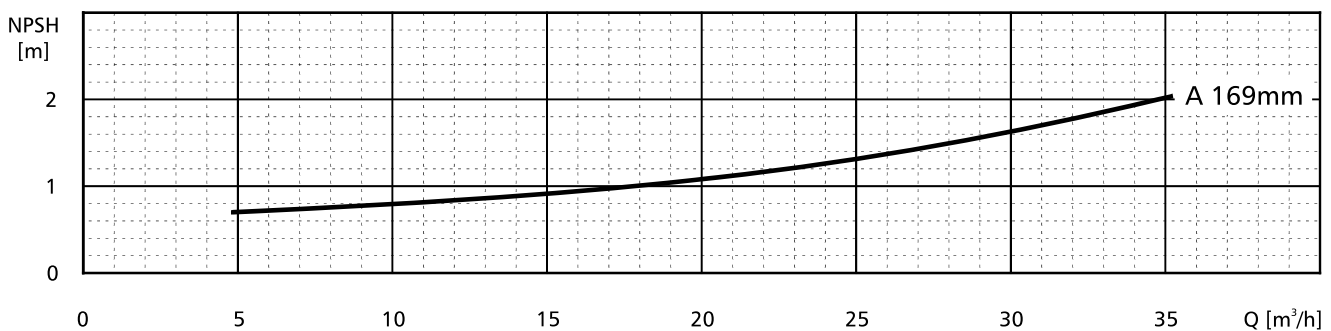
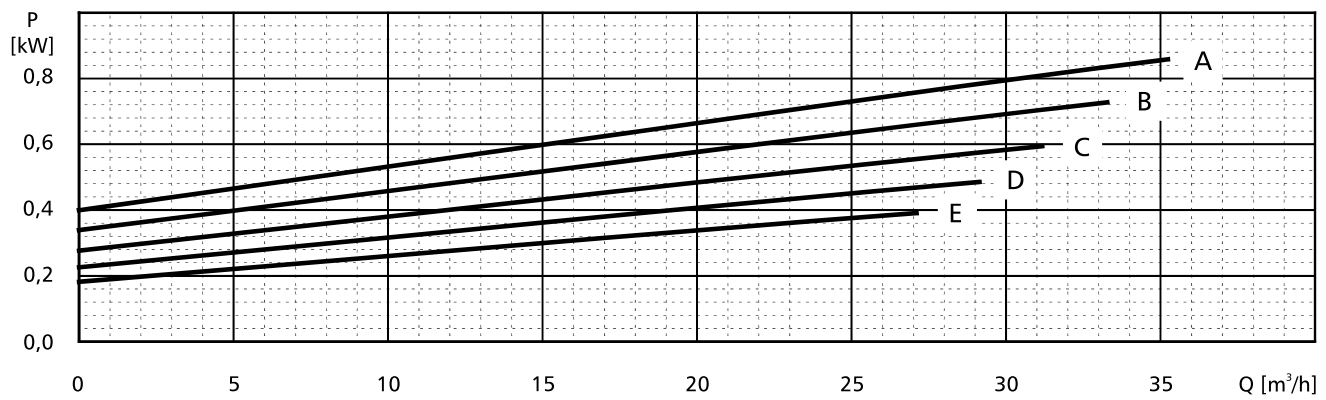
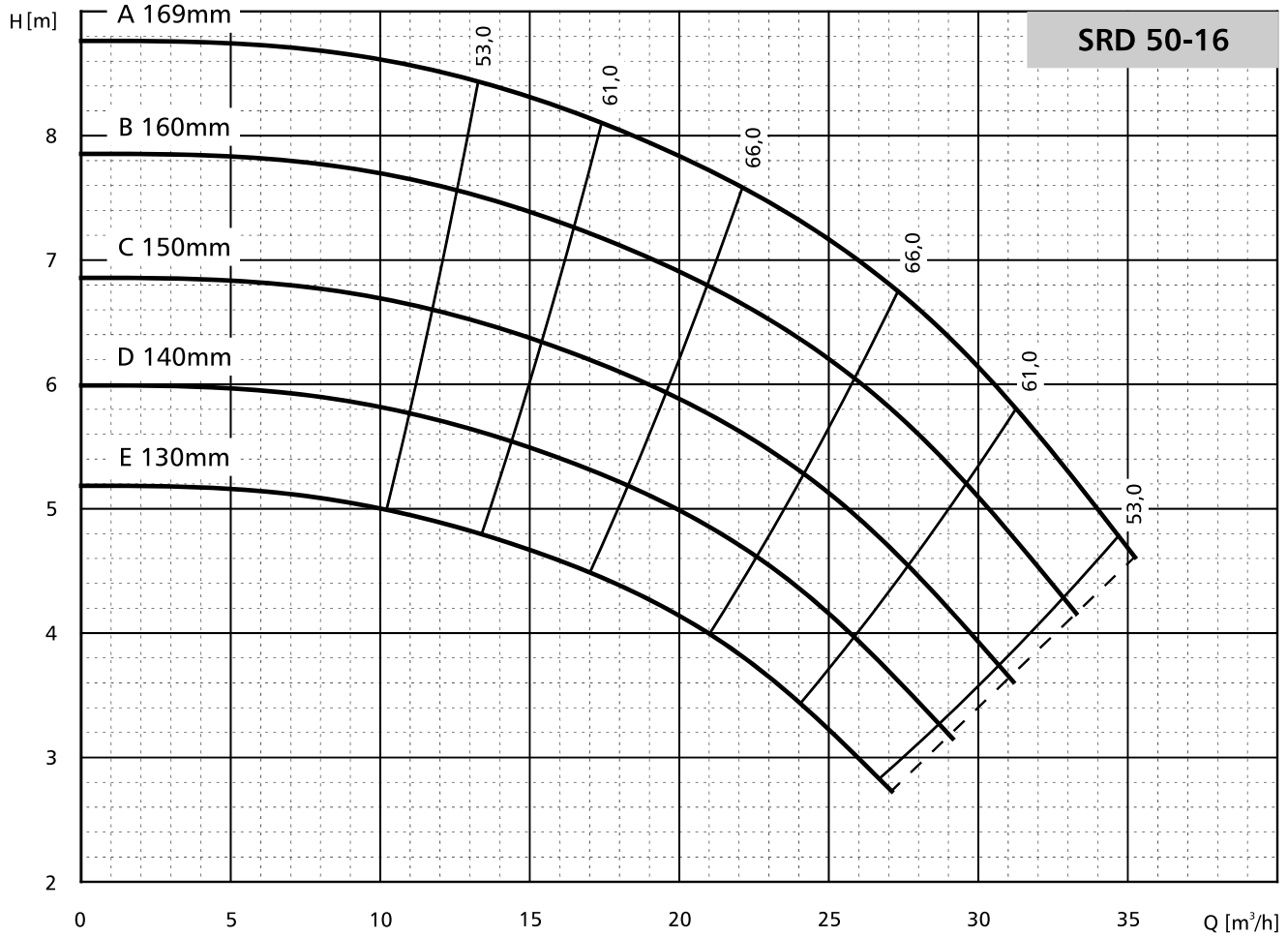

$n=1450\text{min}^{-1}$

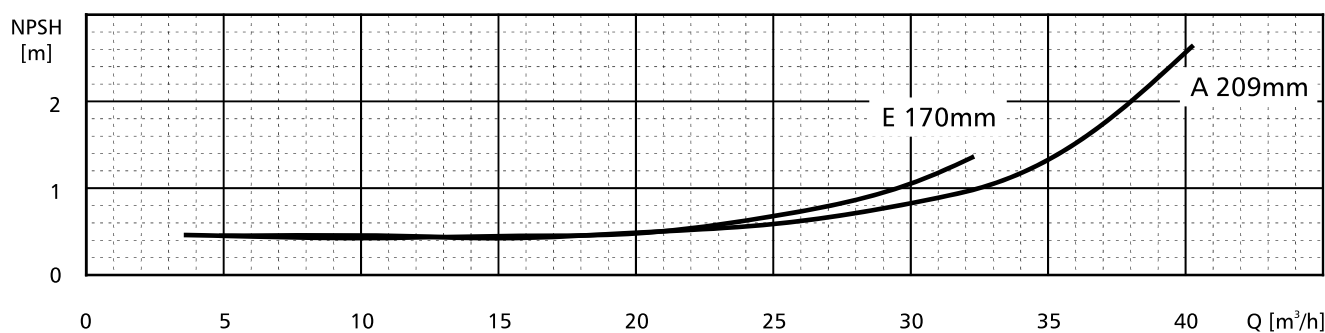
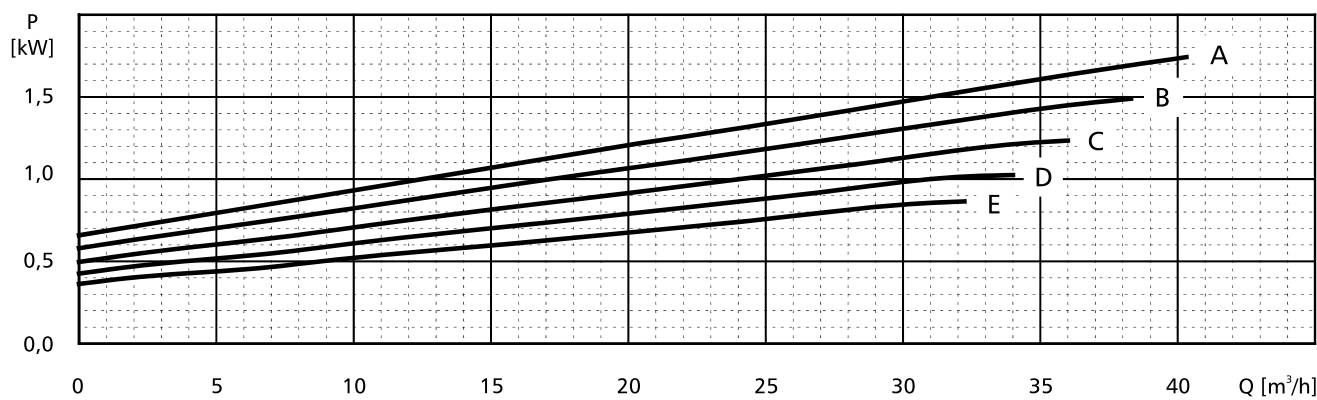
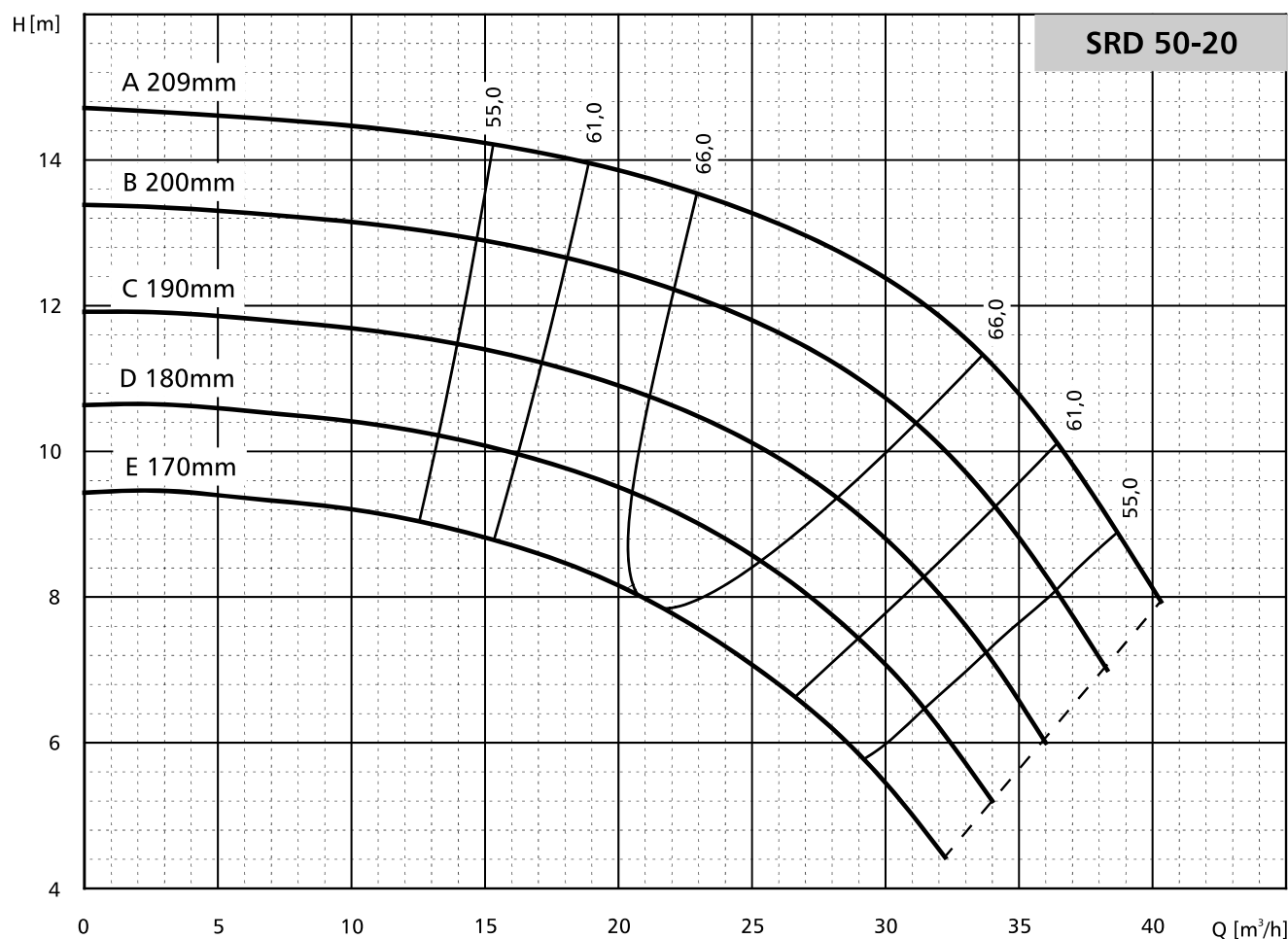

POMPY SPECJALISTYCZNE

$n=1450\text{min}^{-1}$

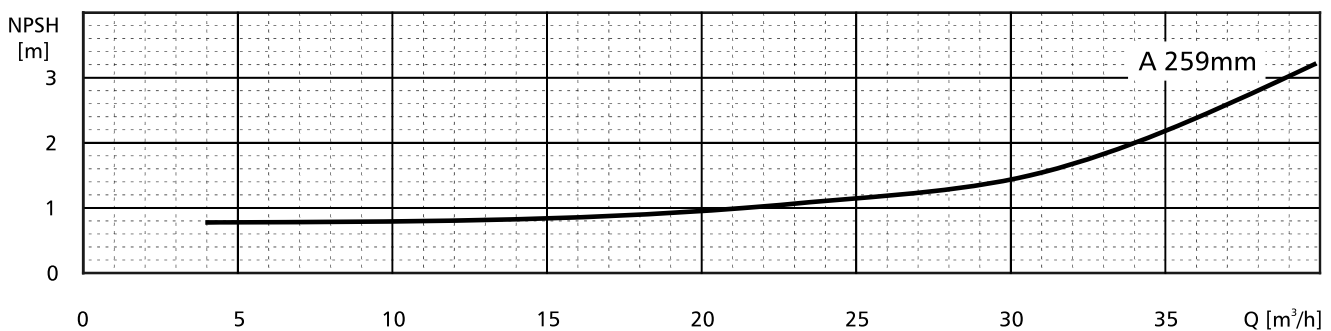
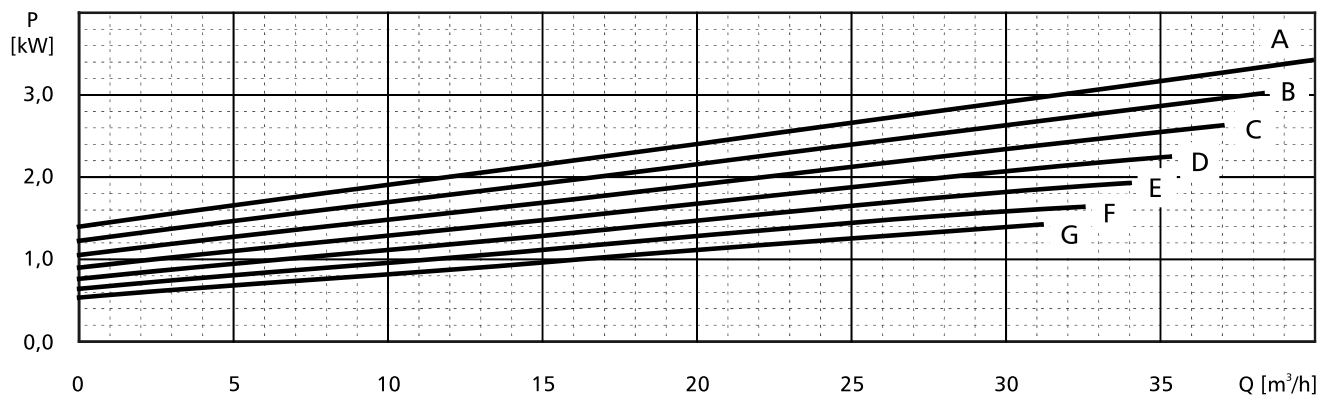
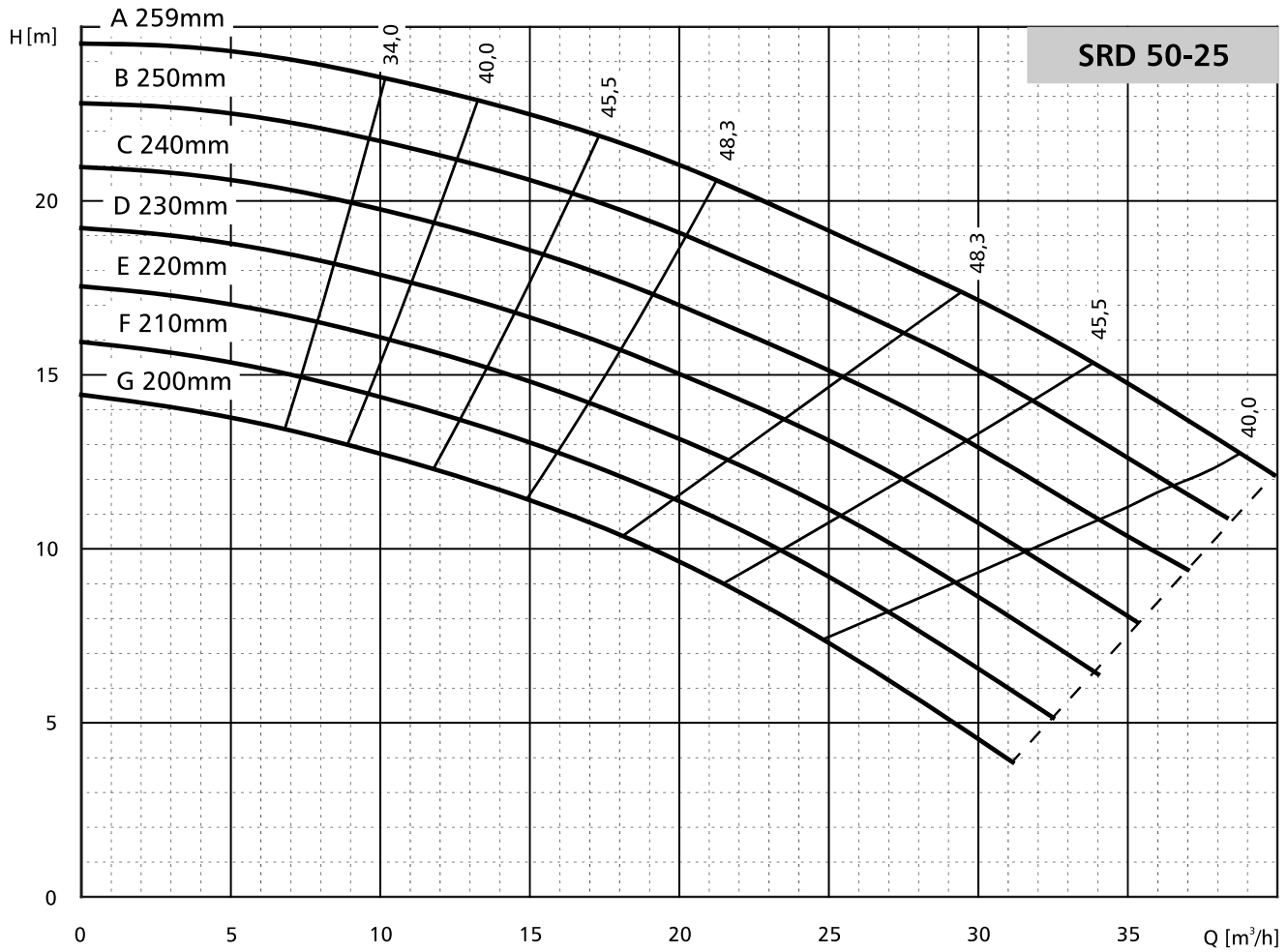

$n=1450\text{min}^{-1}$

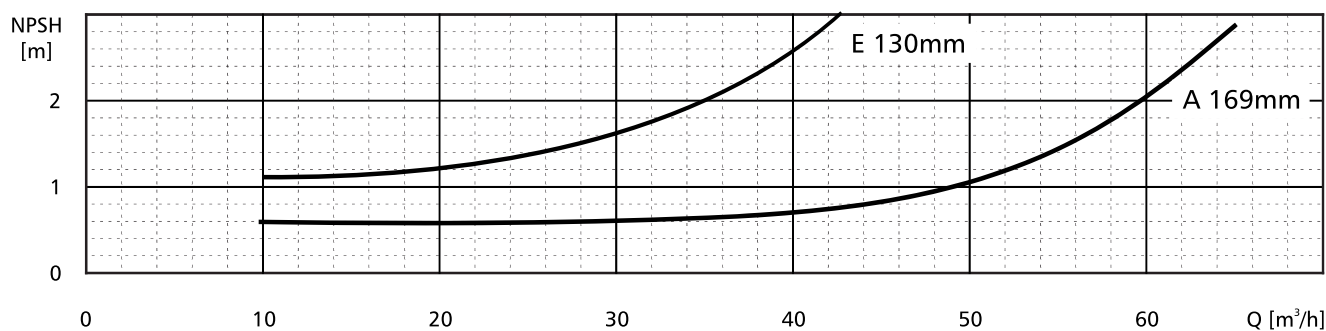
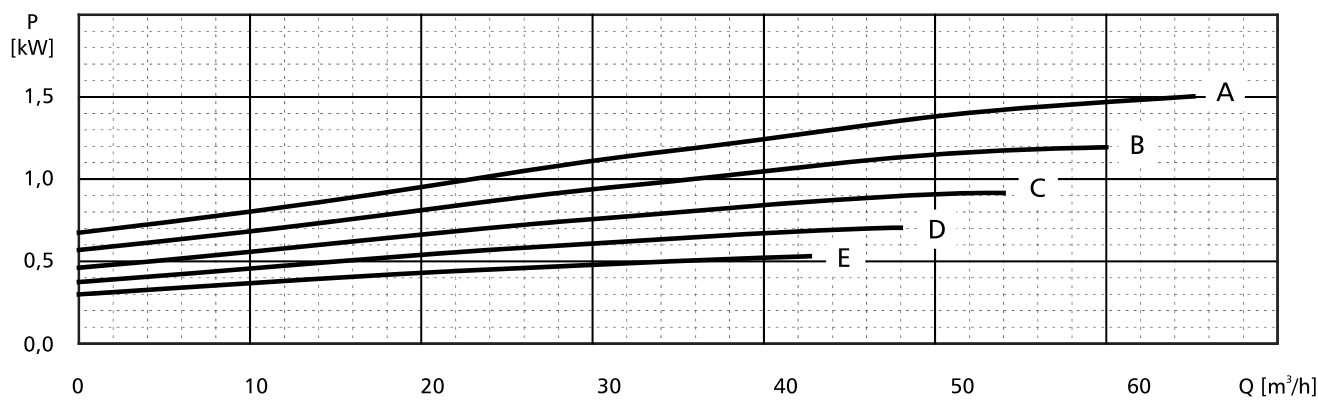
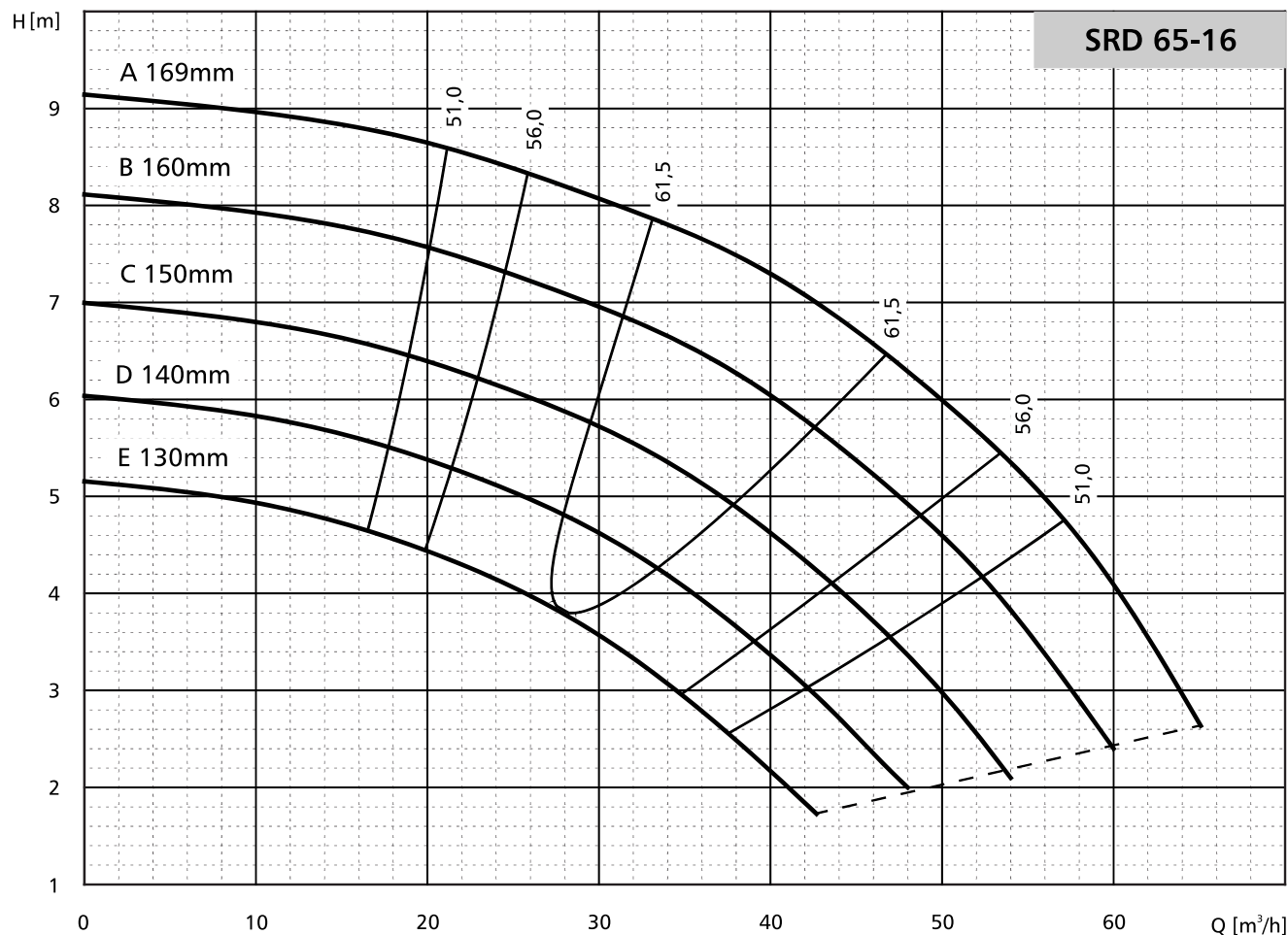

POMPY SPECJALISTYCZNE

$n=1450\text{min}^{-1}$

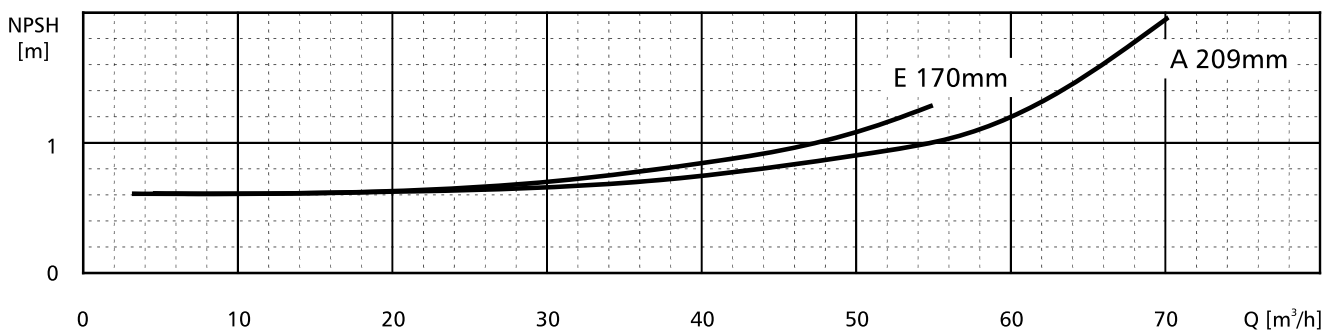
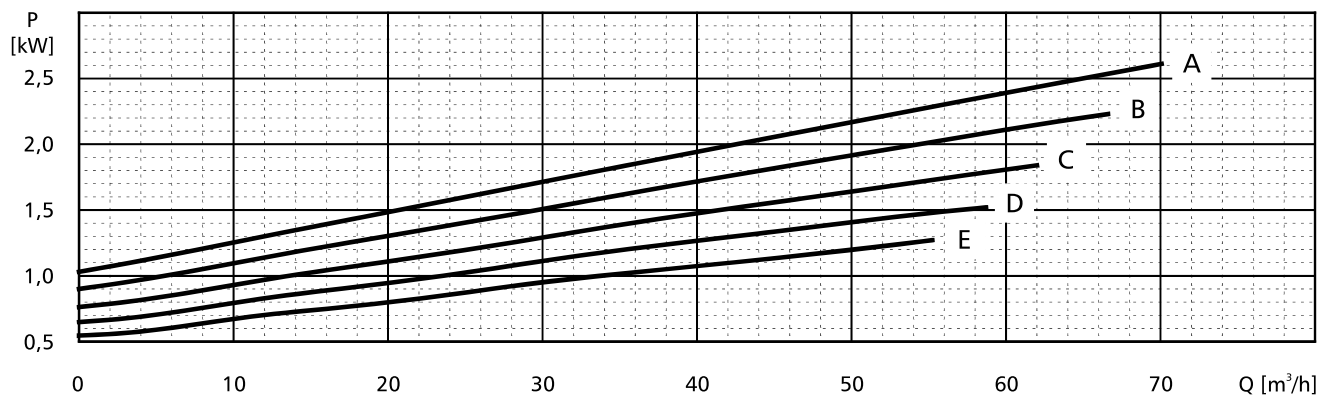
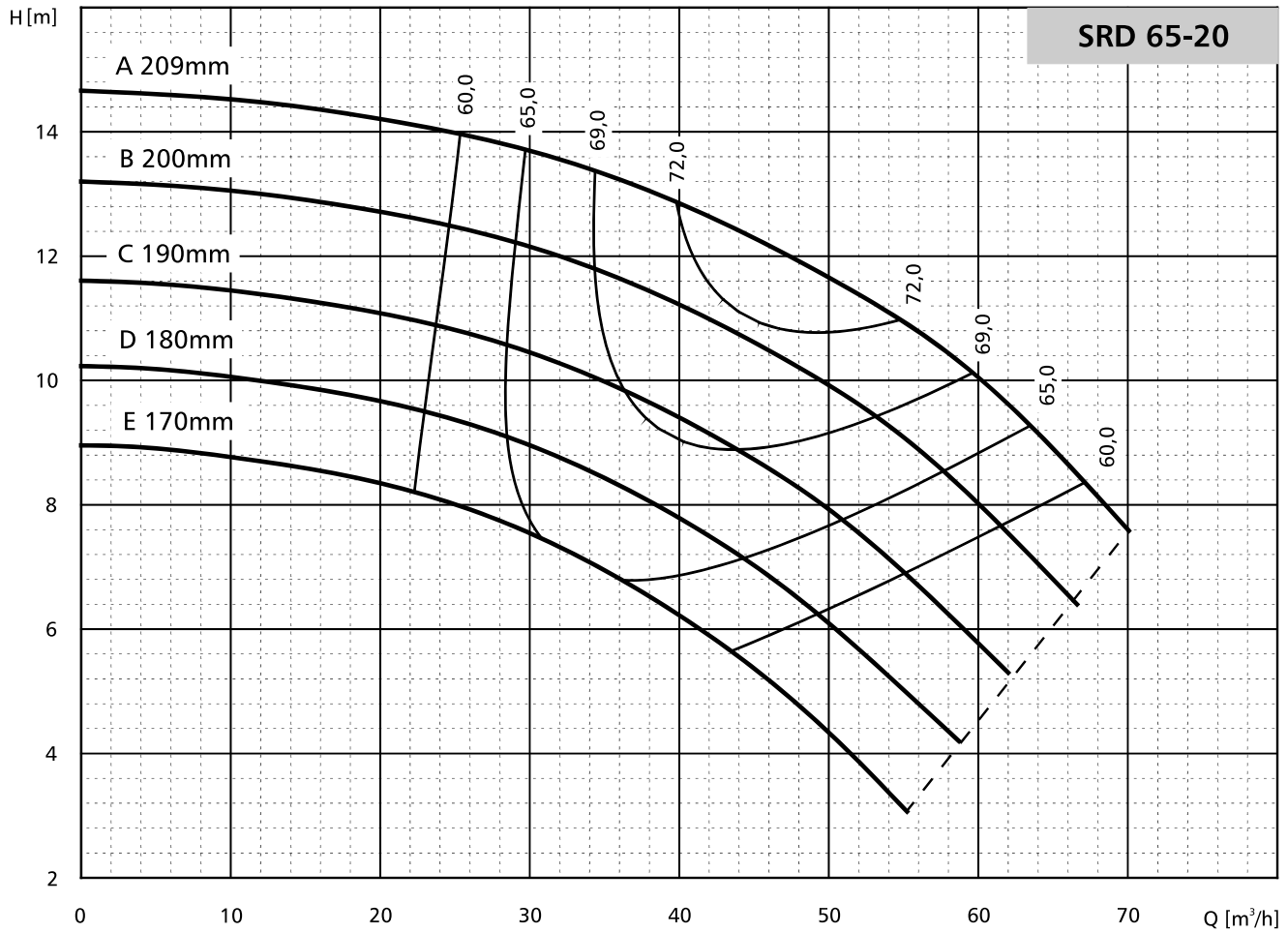

$n=1450\text{min}^{-1}$

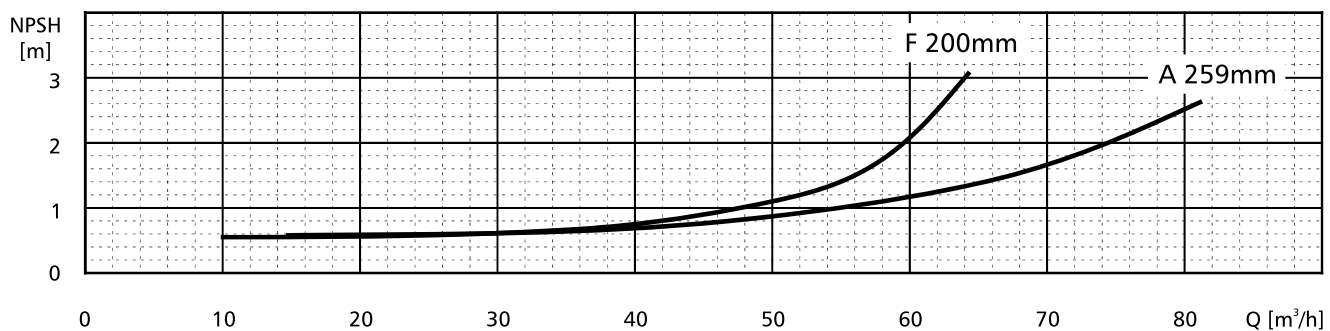
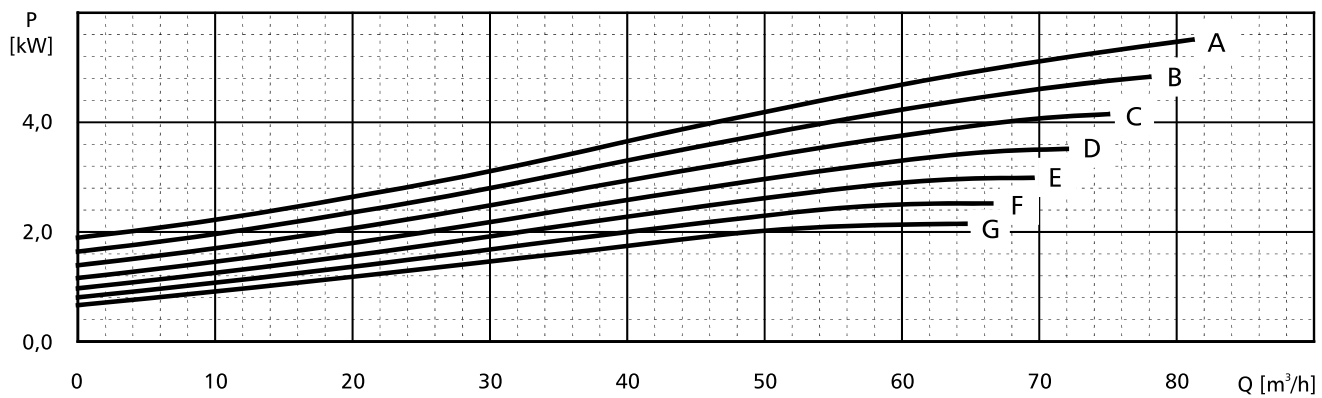
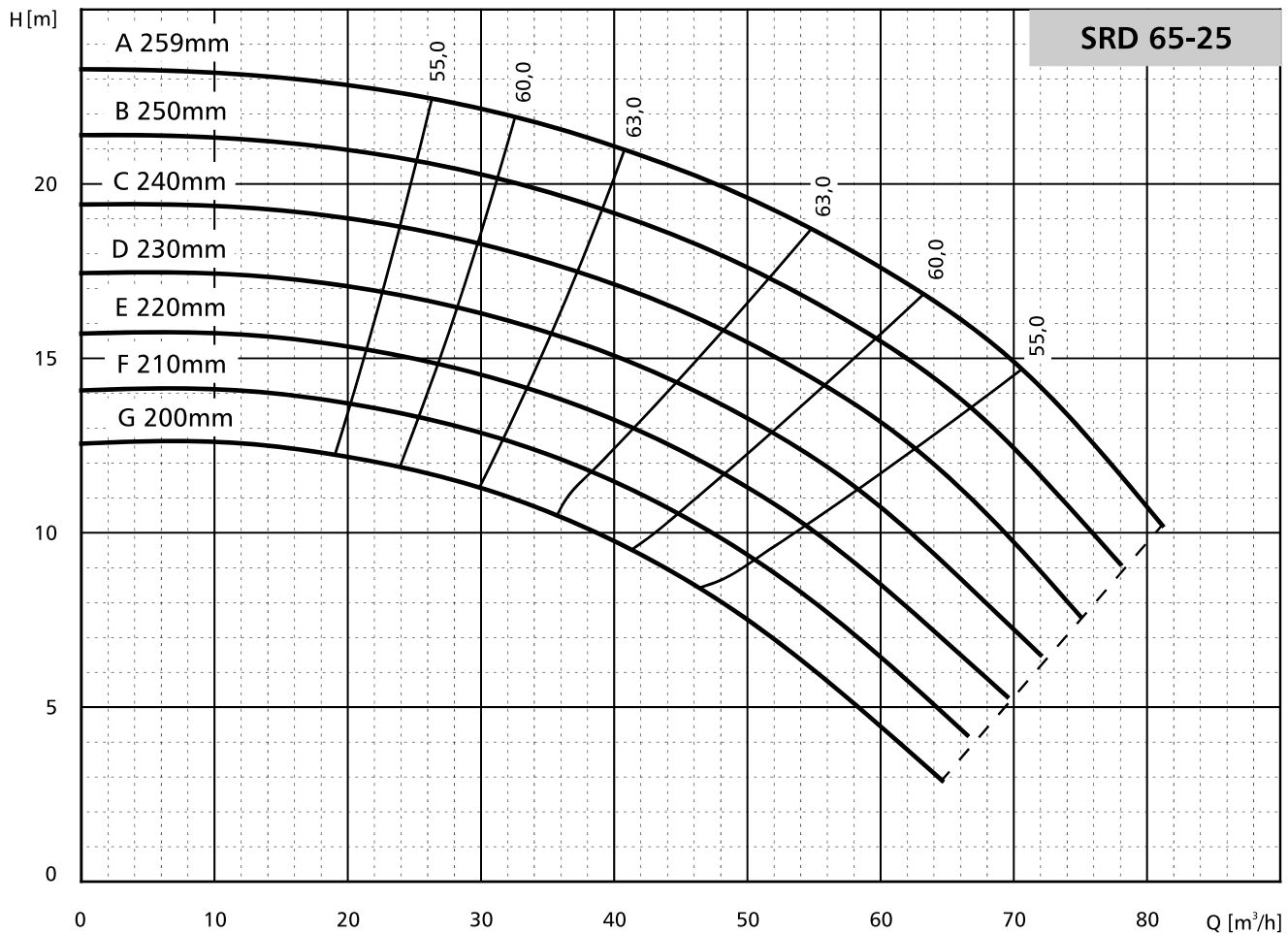

POMPY SPECJALISTYCZNE

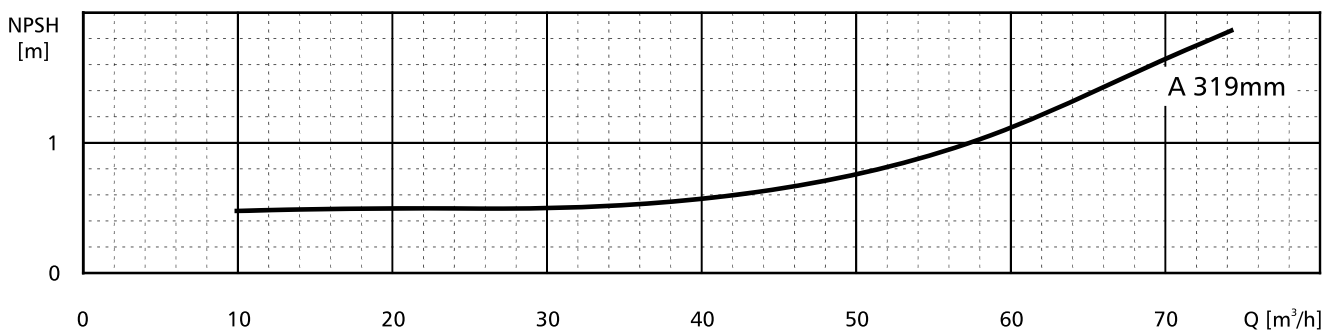
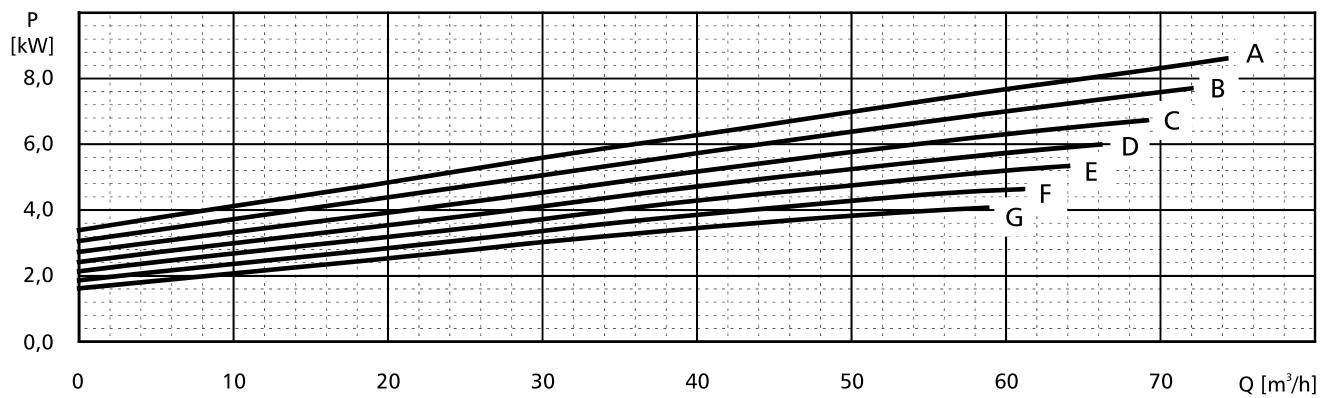
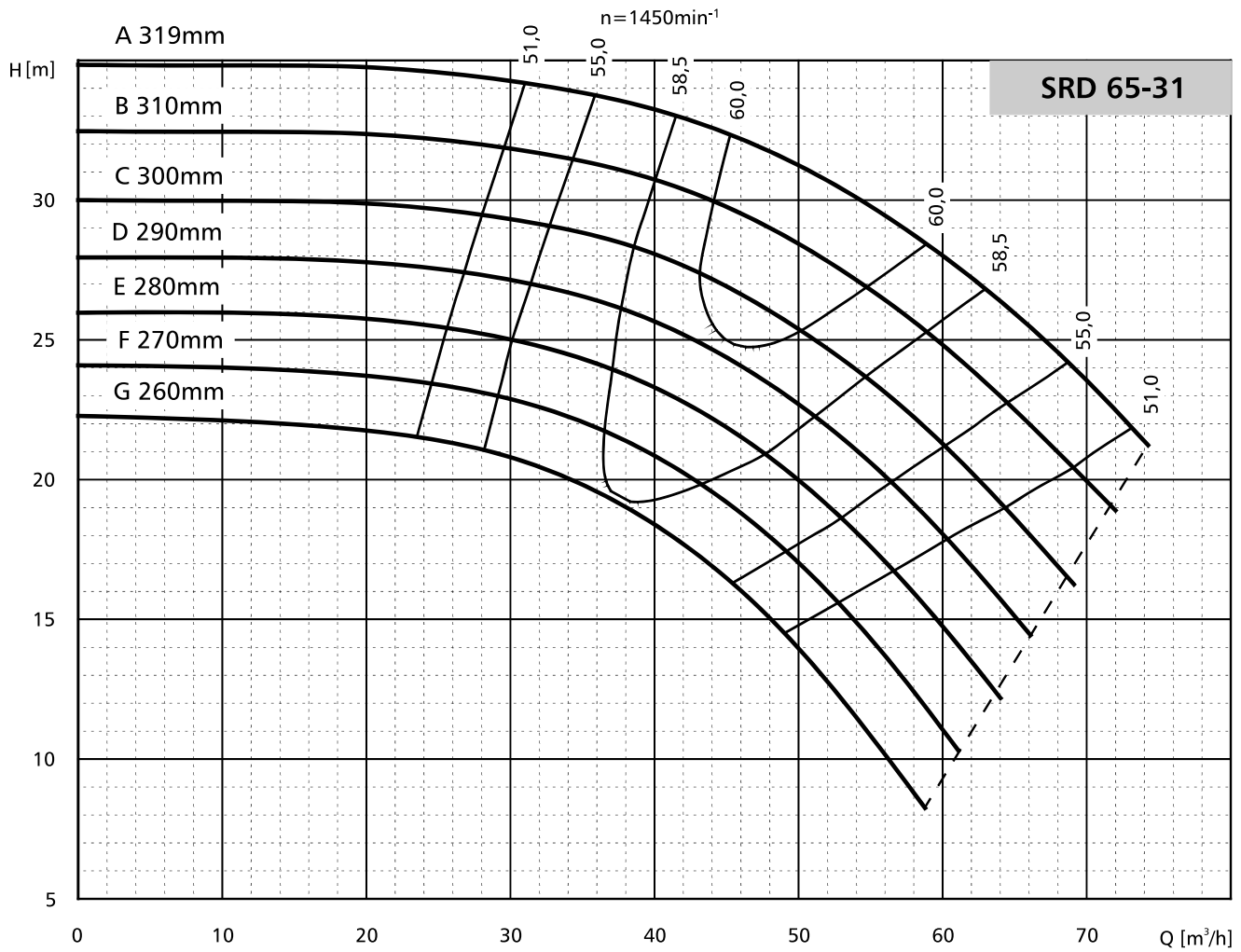

$n=1450\text{min}^{-1}$

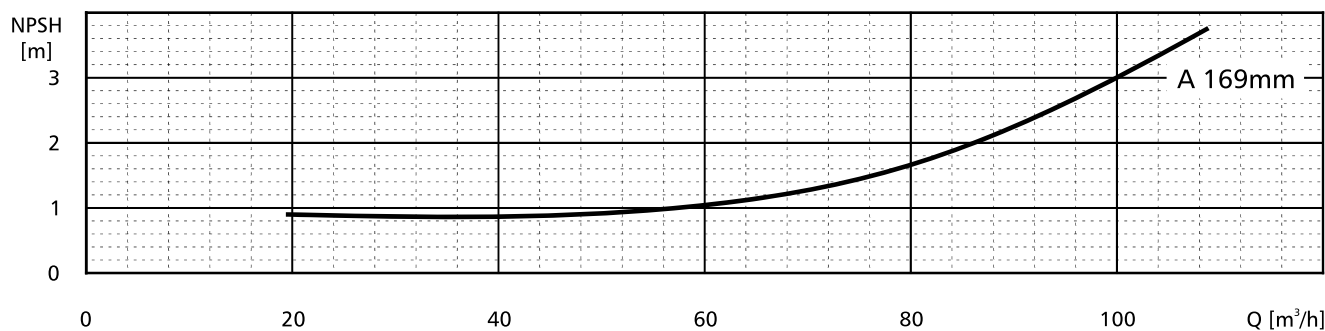
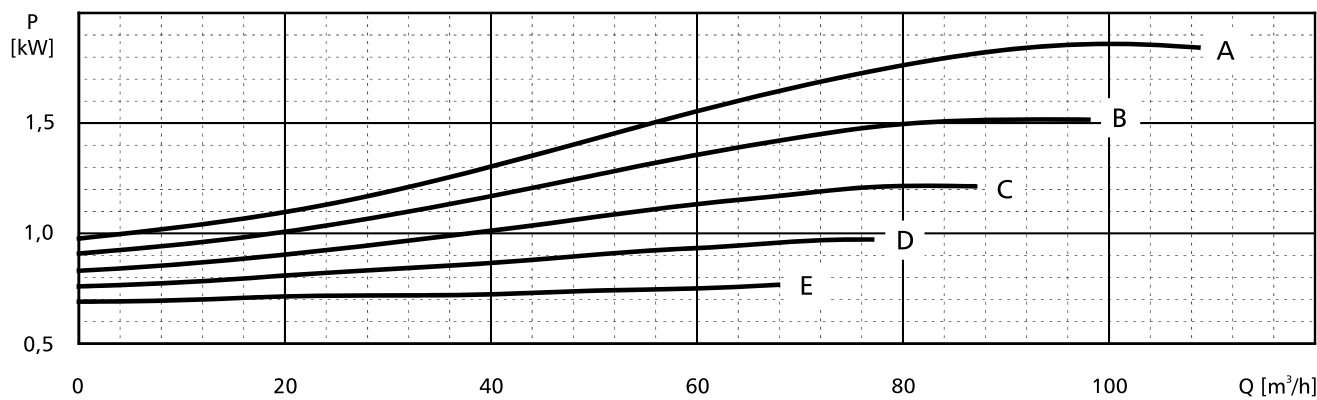
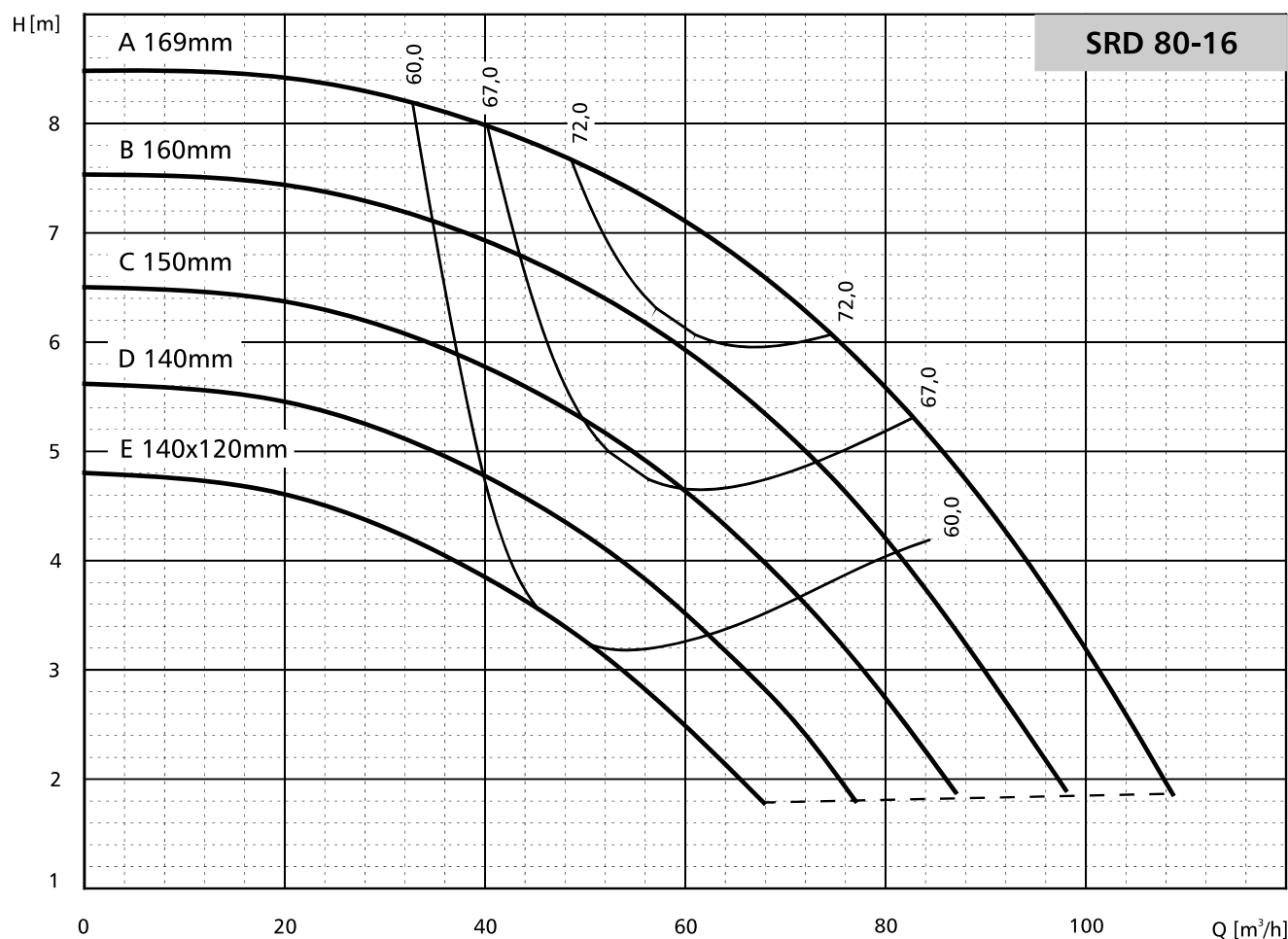

$n=1450\text{min}^{-1}$

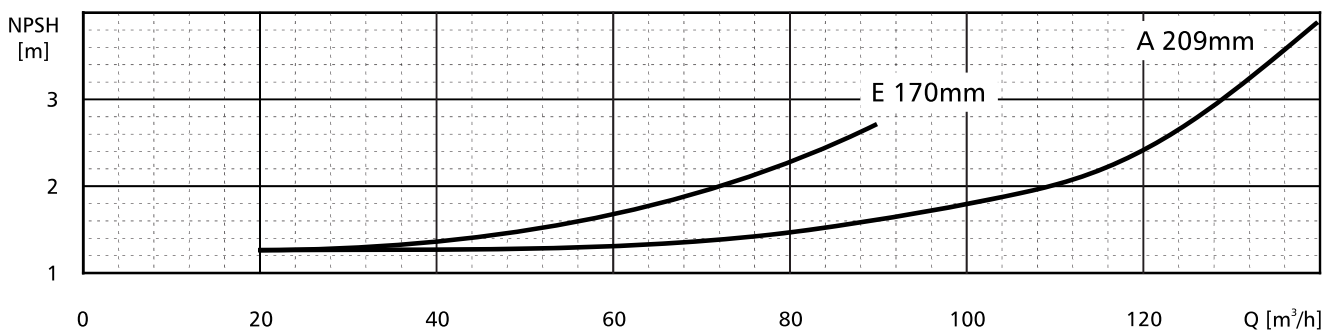
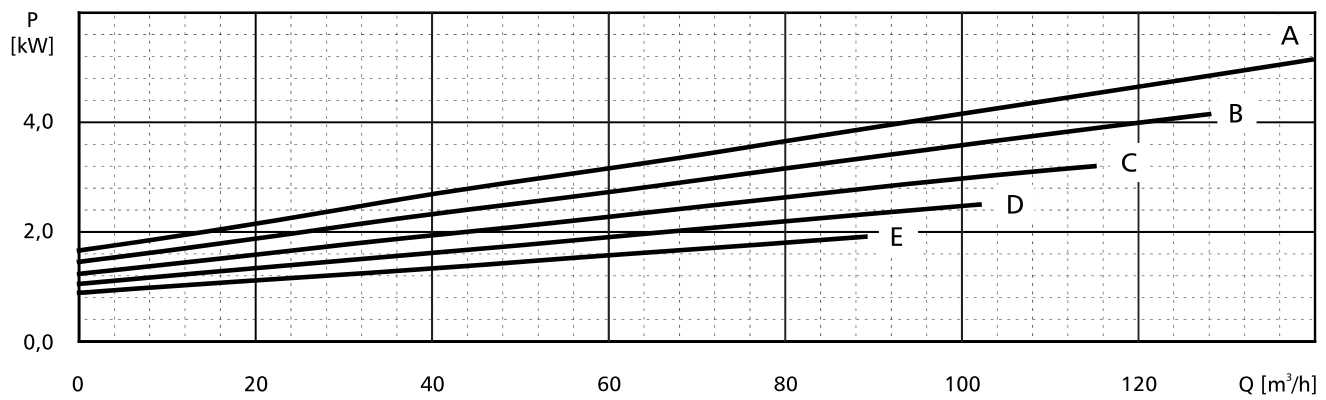
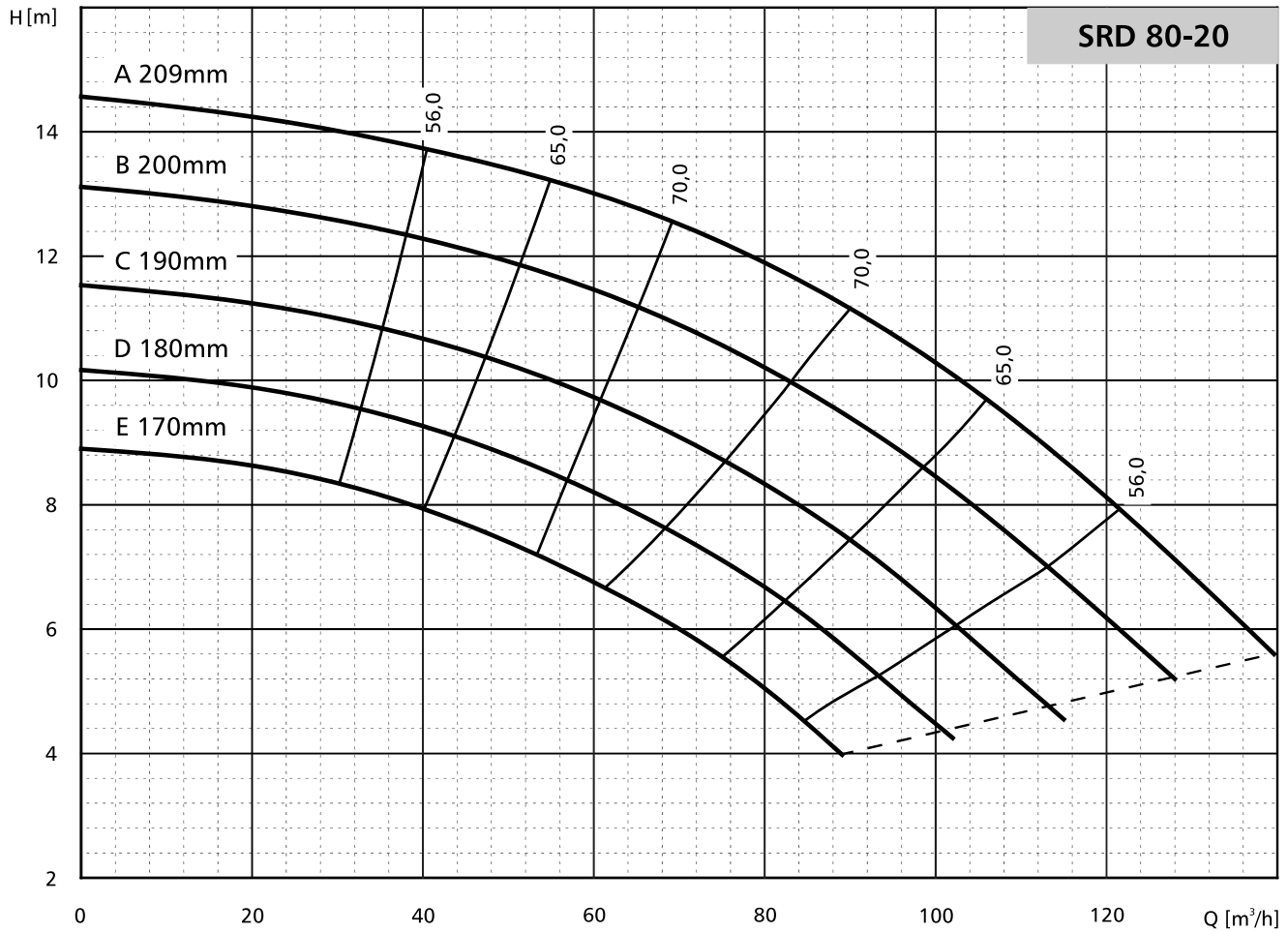

$n=1450\text{min}^{-1}$

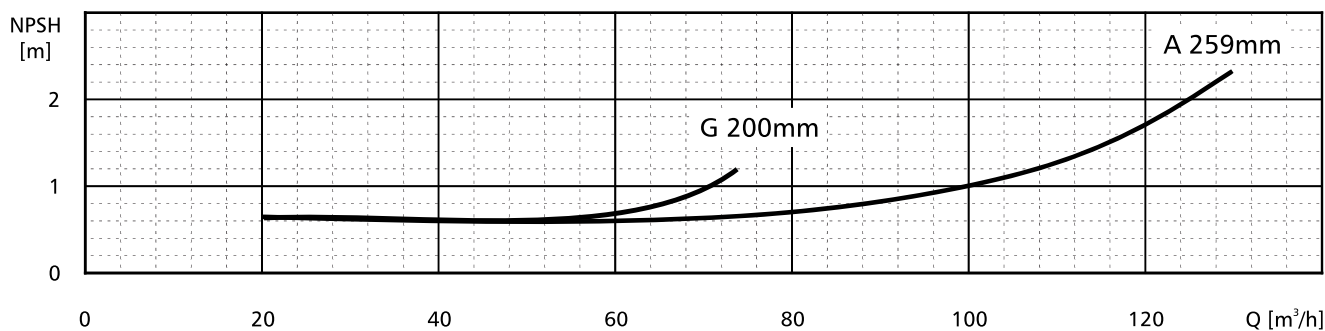
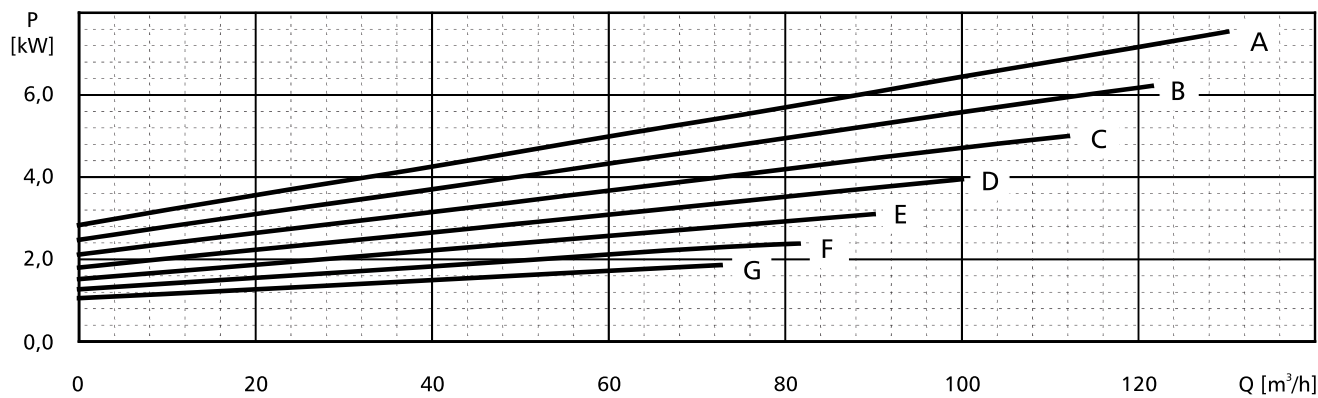
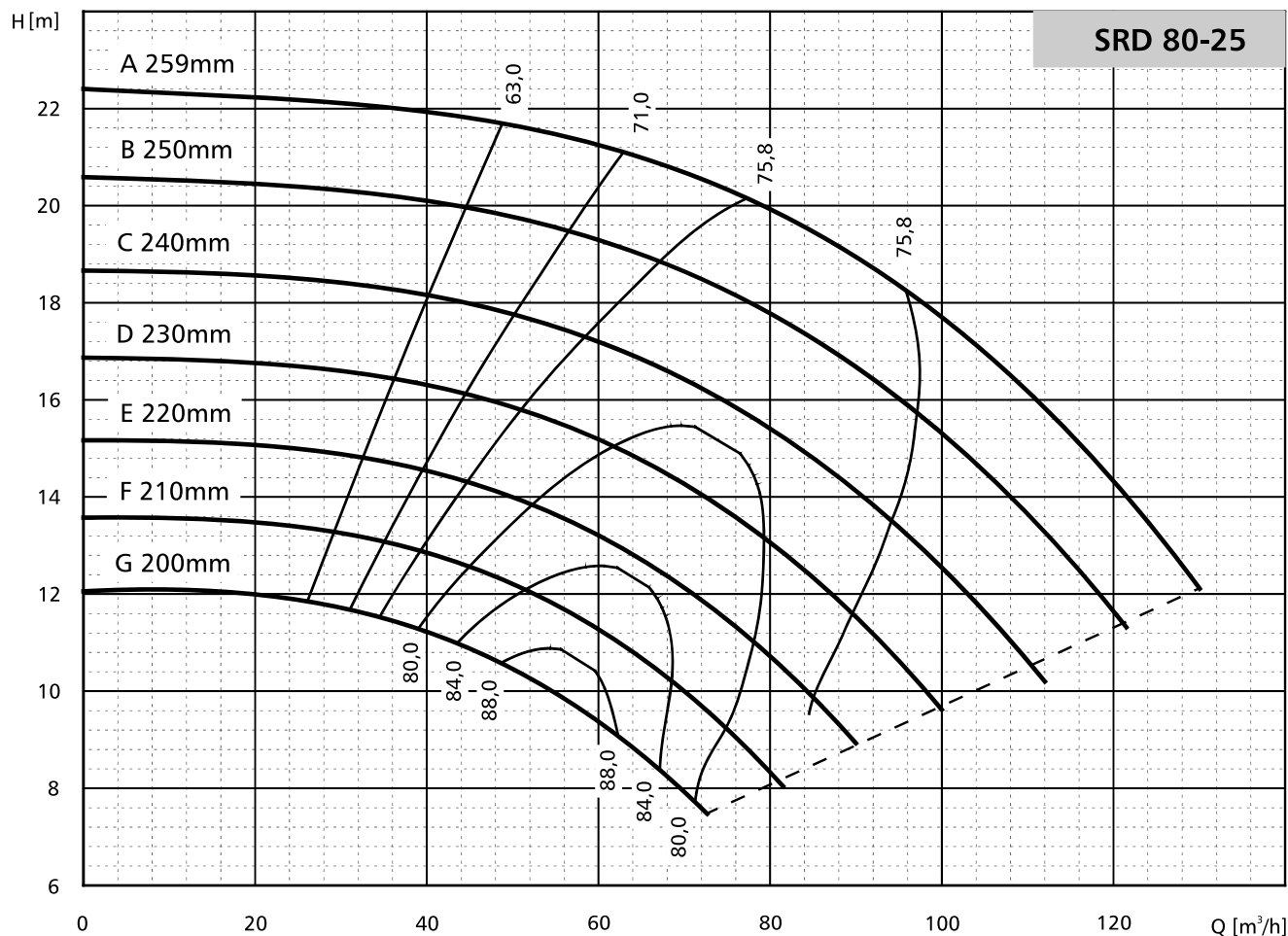

POMPY SPECJALISTYCZNE

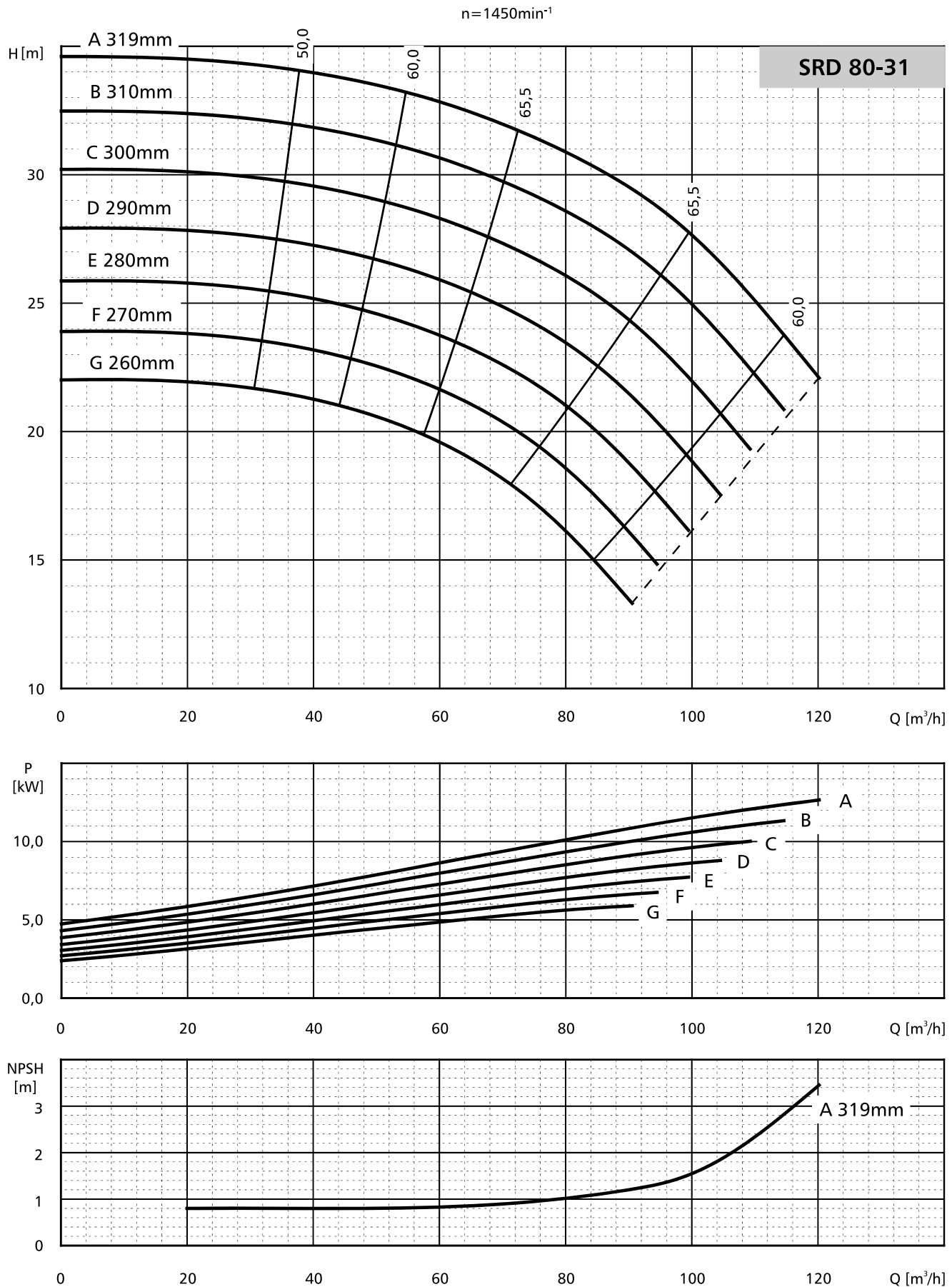

$n=1450\text{min}^{-1}$

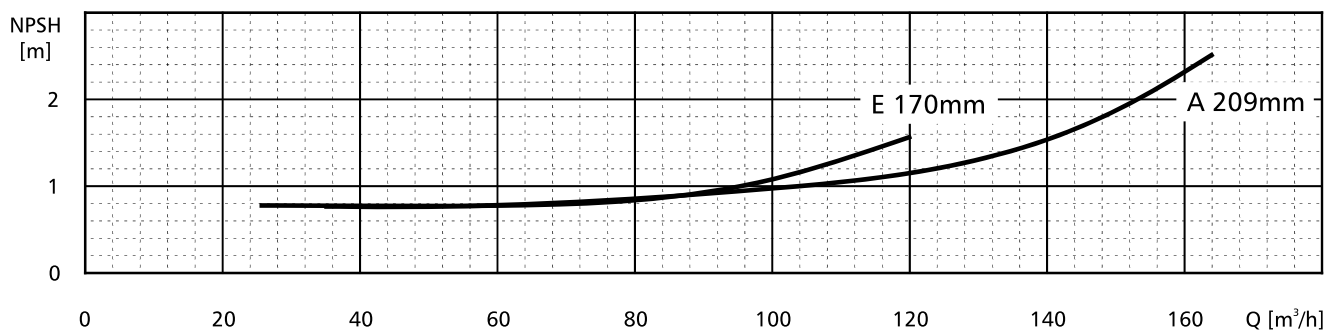
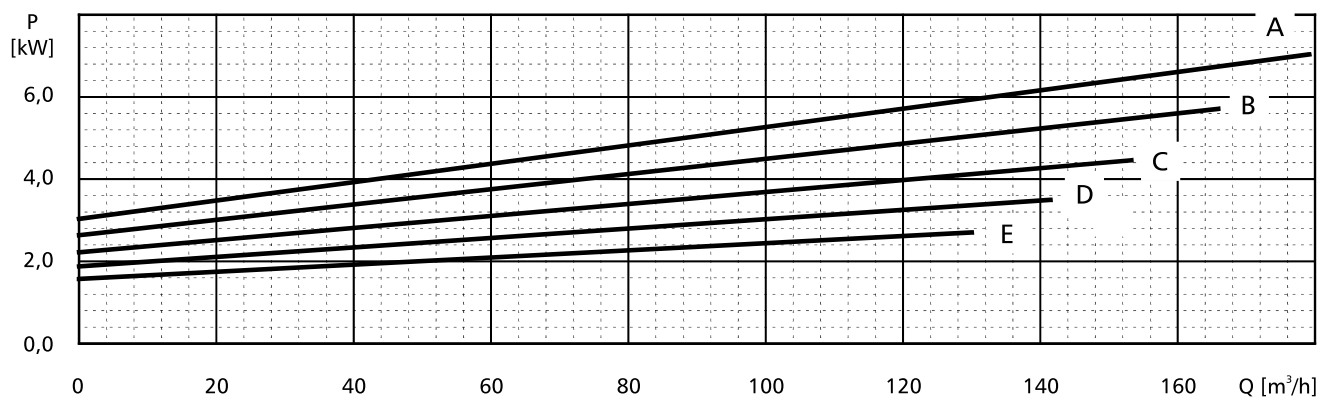
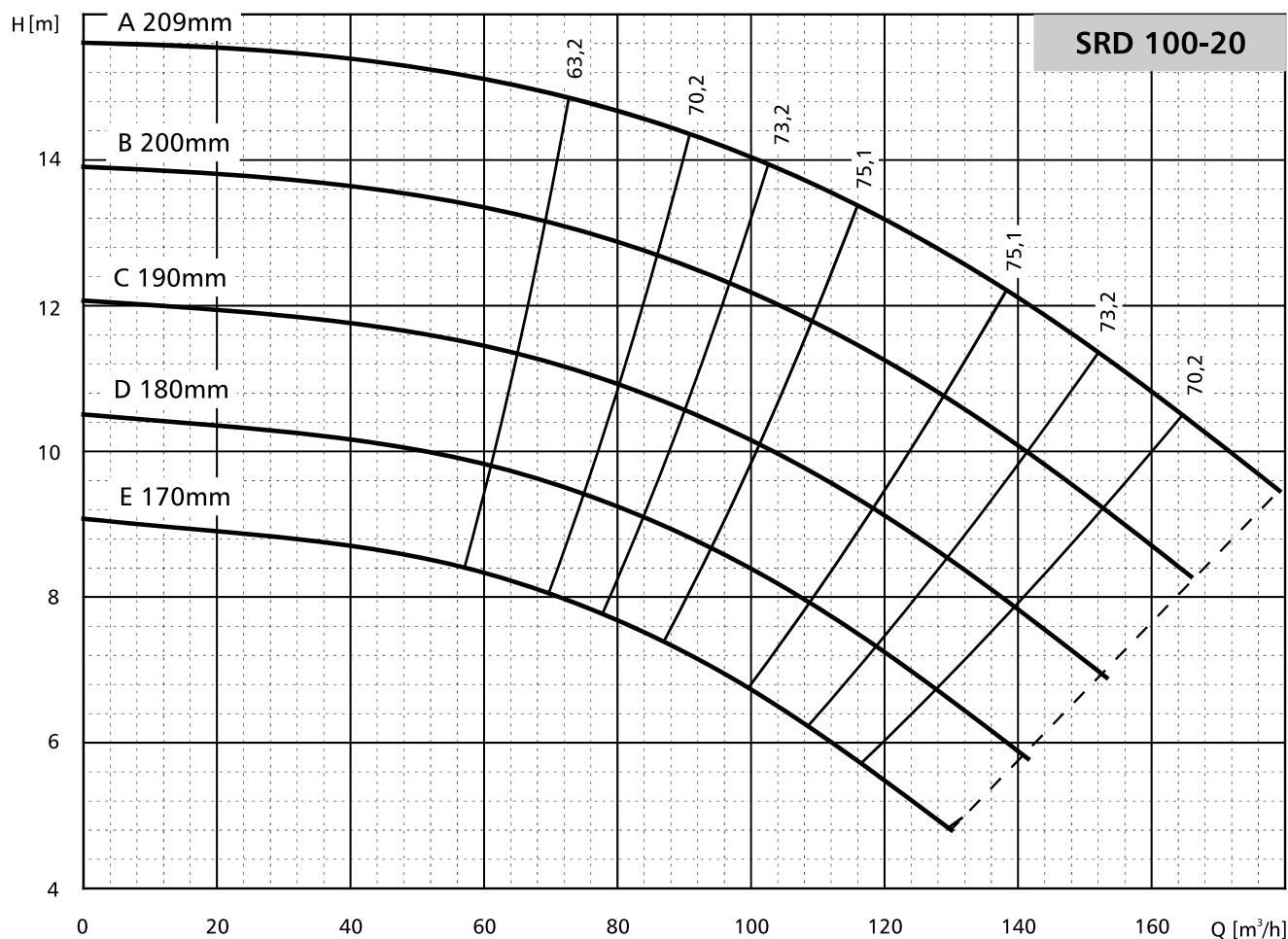

$n=1450\text{min}^{-1}$

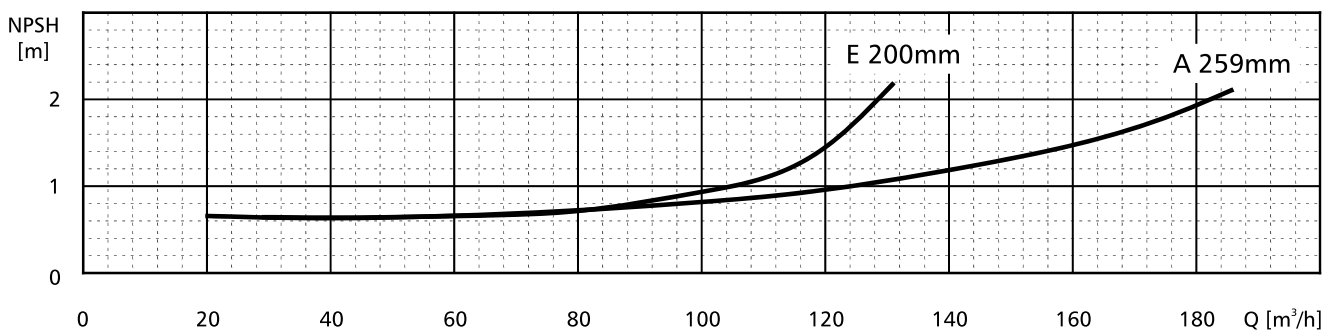
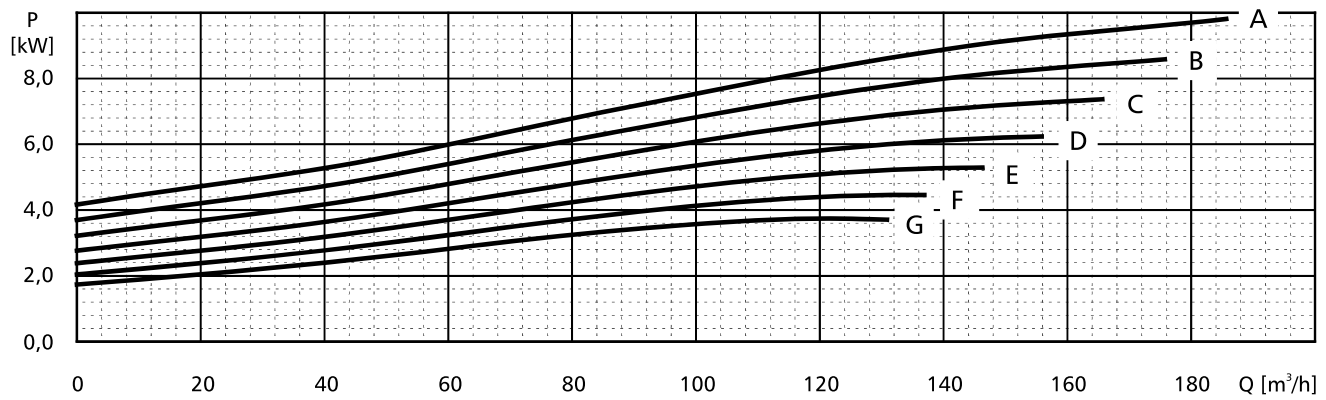
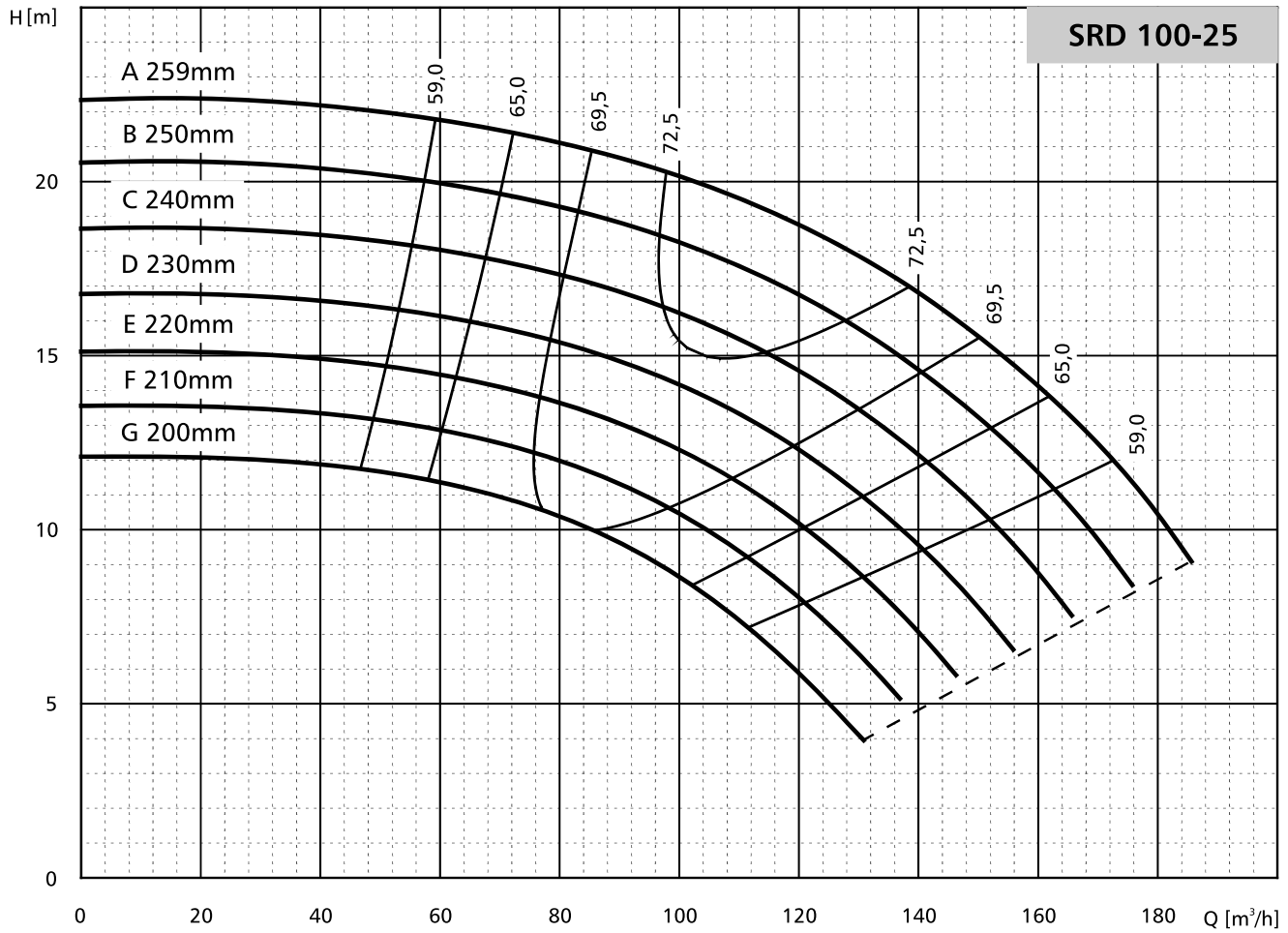

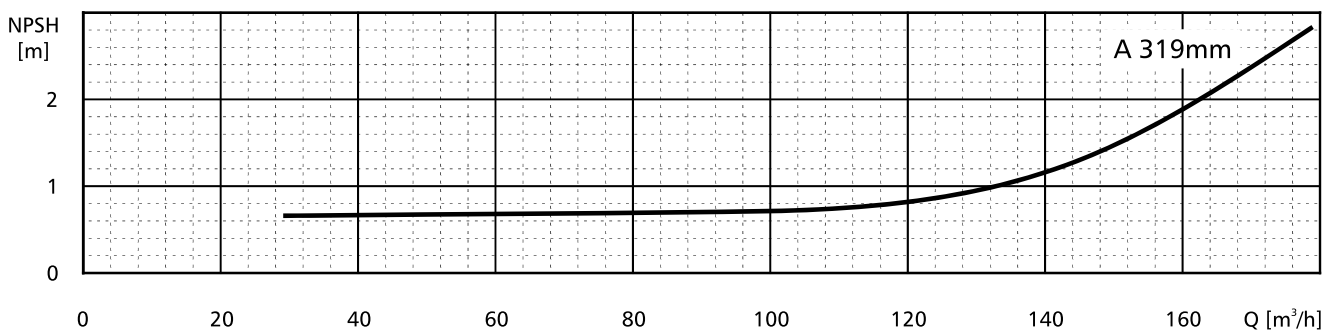
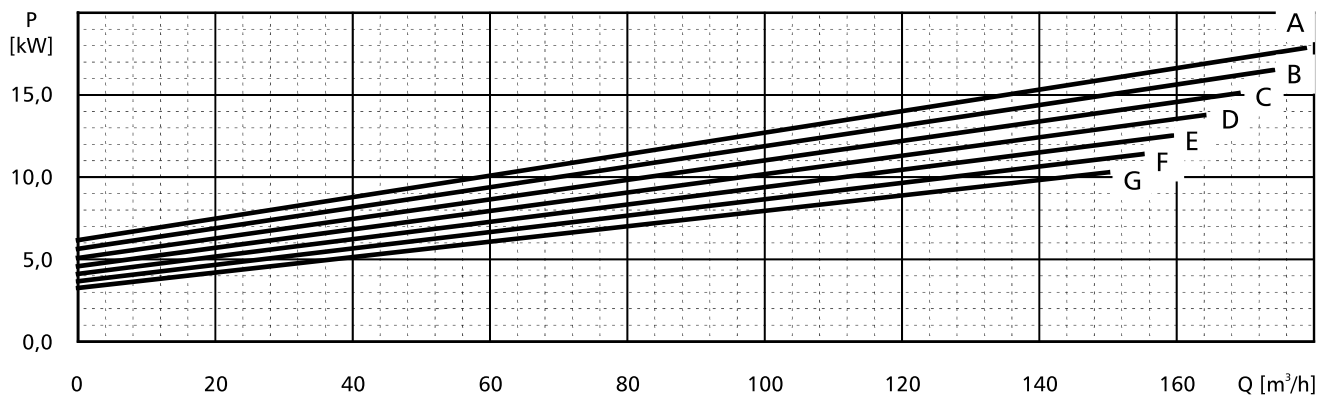
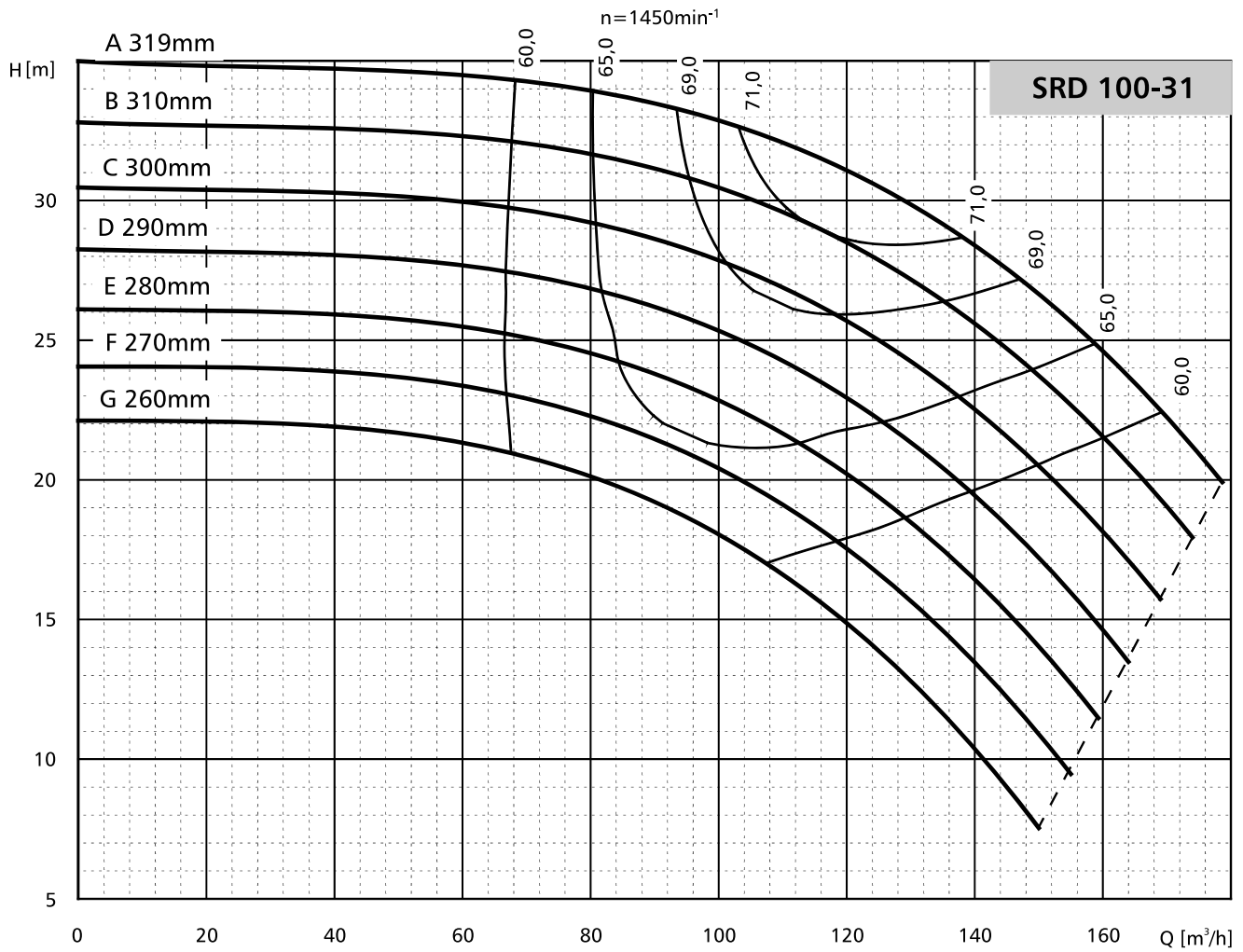

POMPY SPECJALISTYCZNE

$n=1450\text{min}^{-1}$

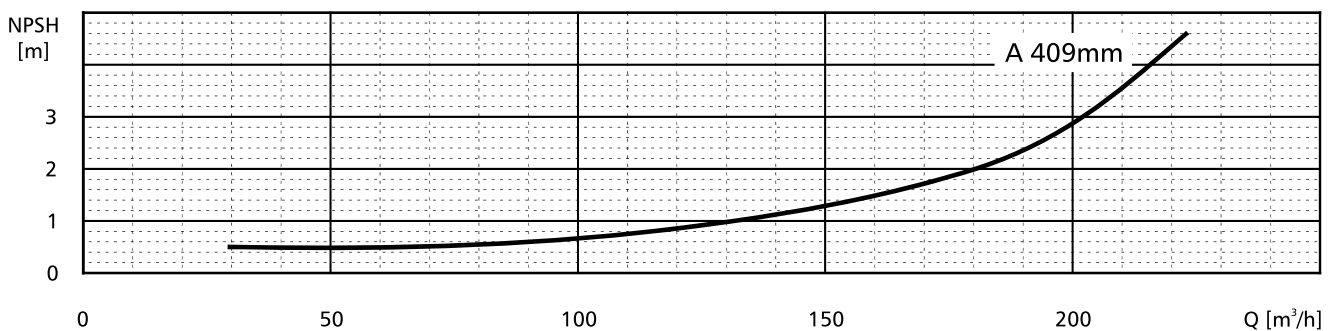
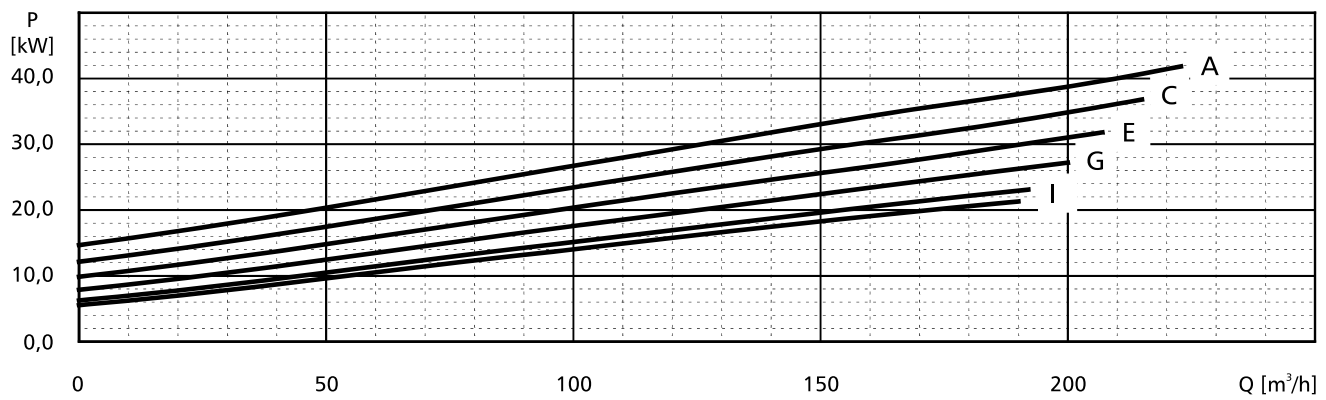
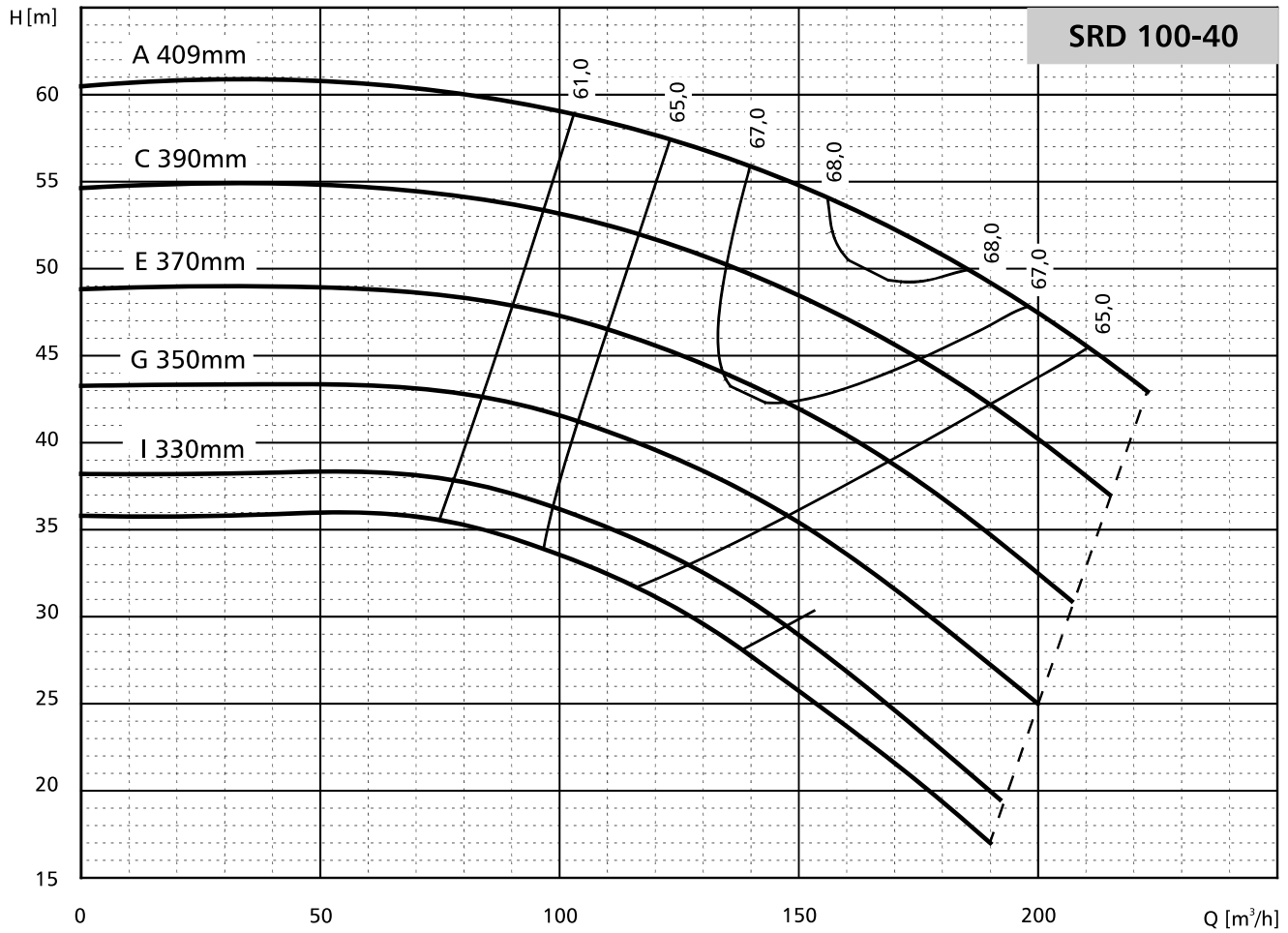

$n=1450\text{min}^{-1}$

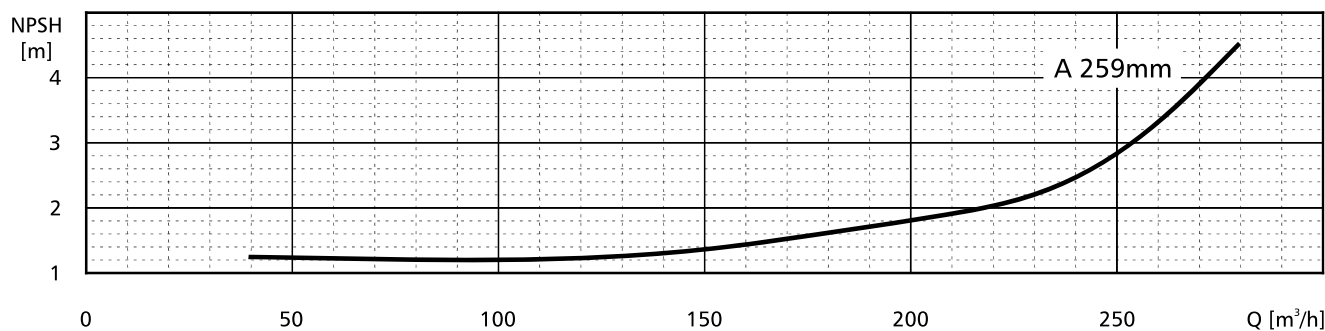
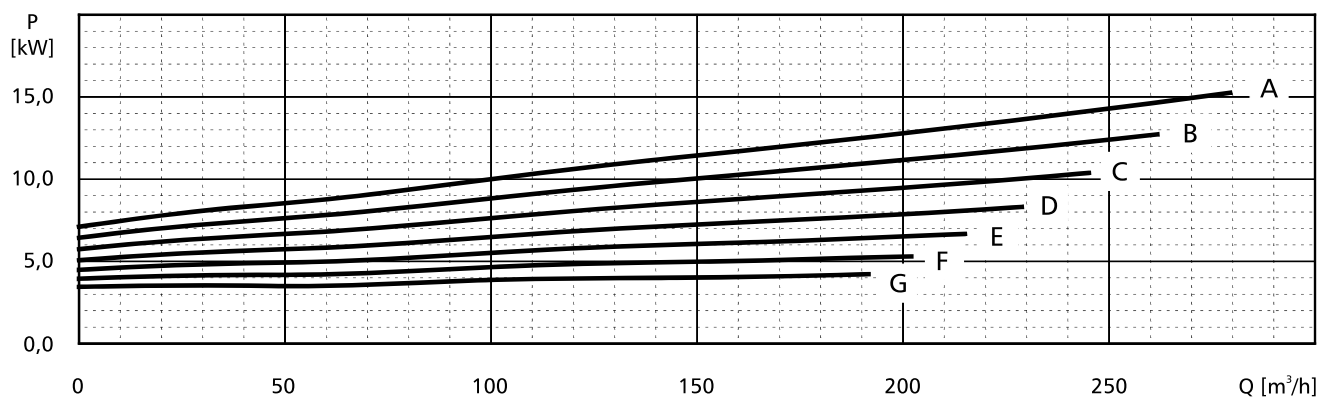
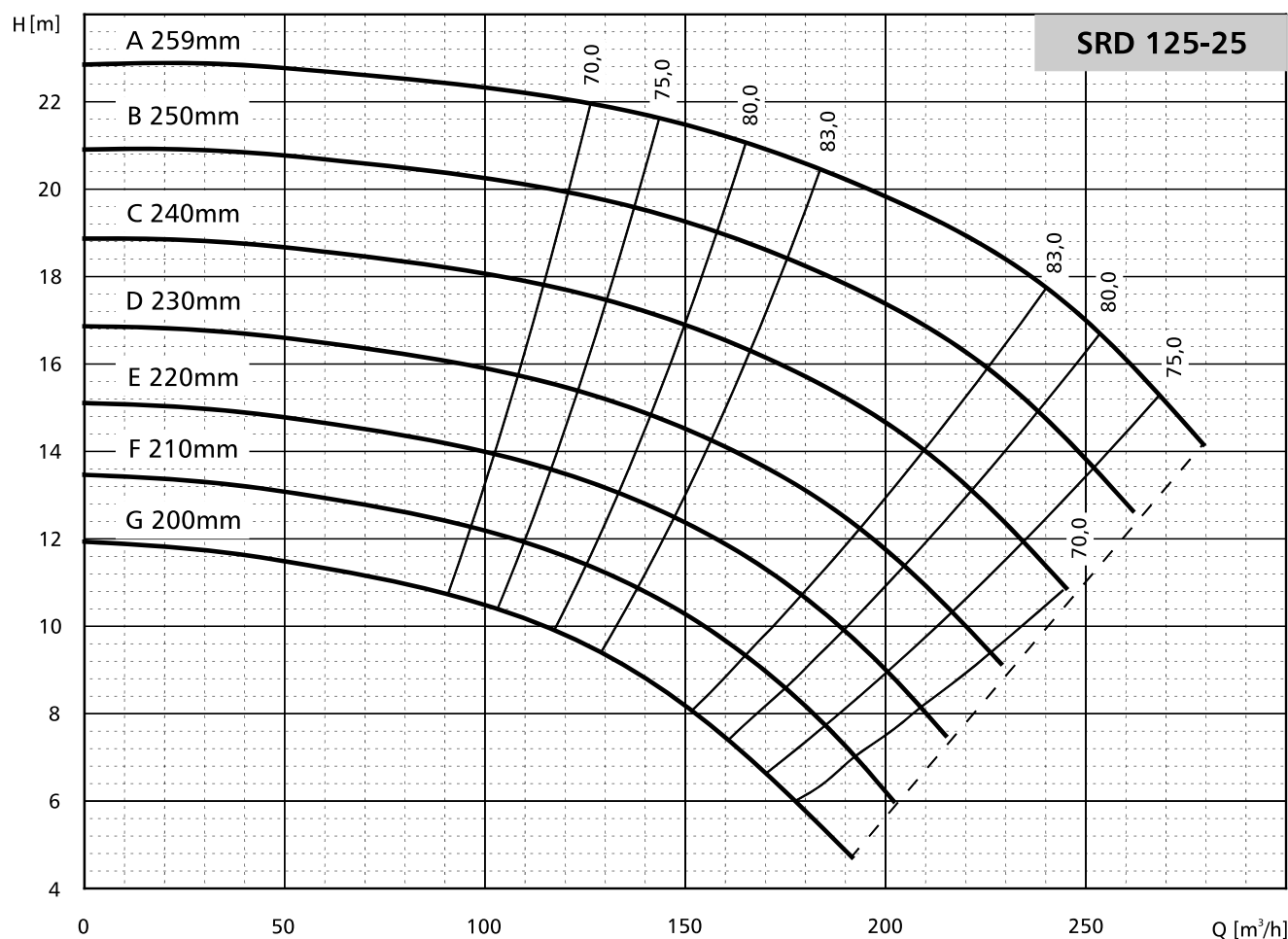

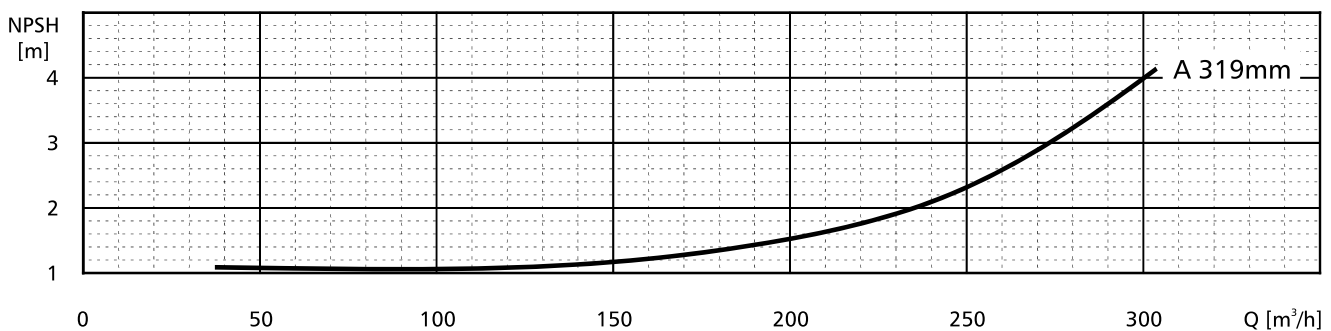
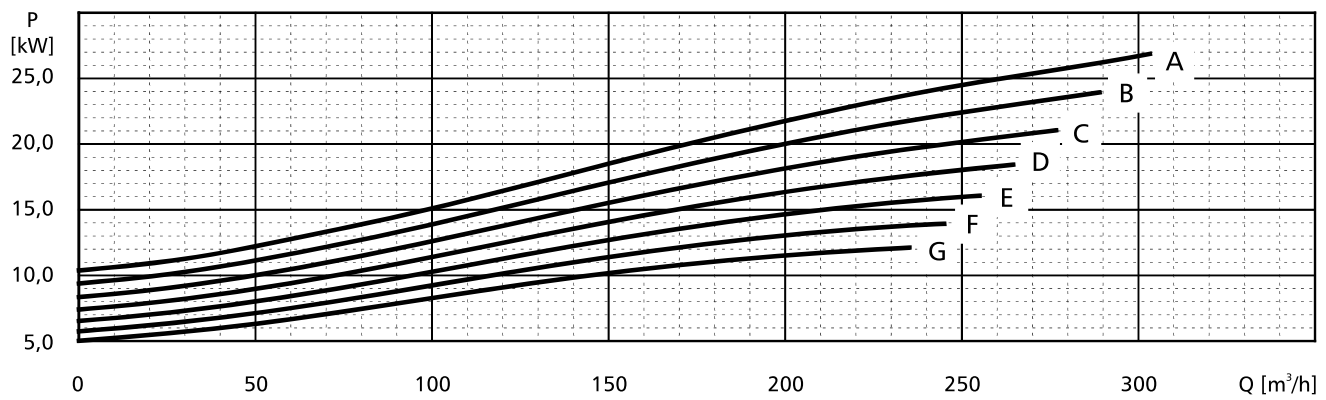
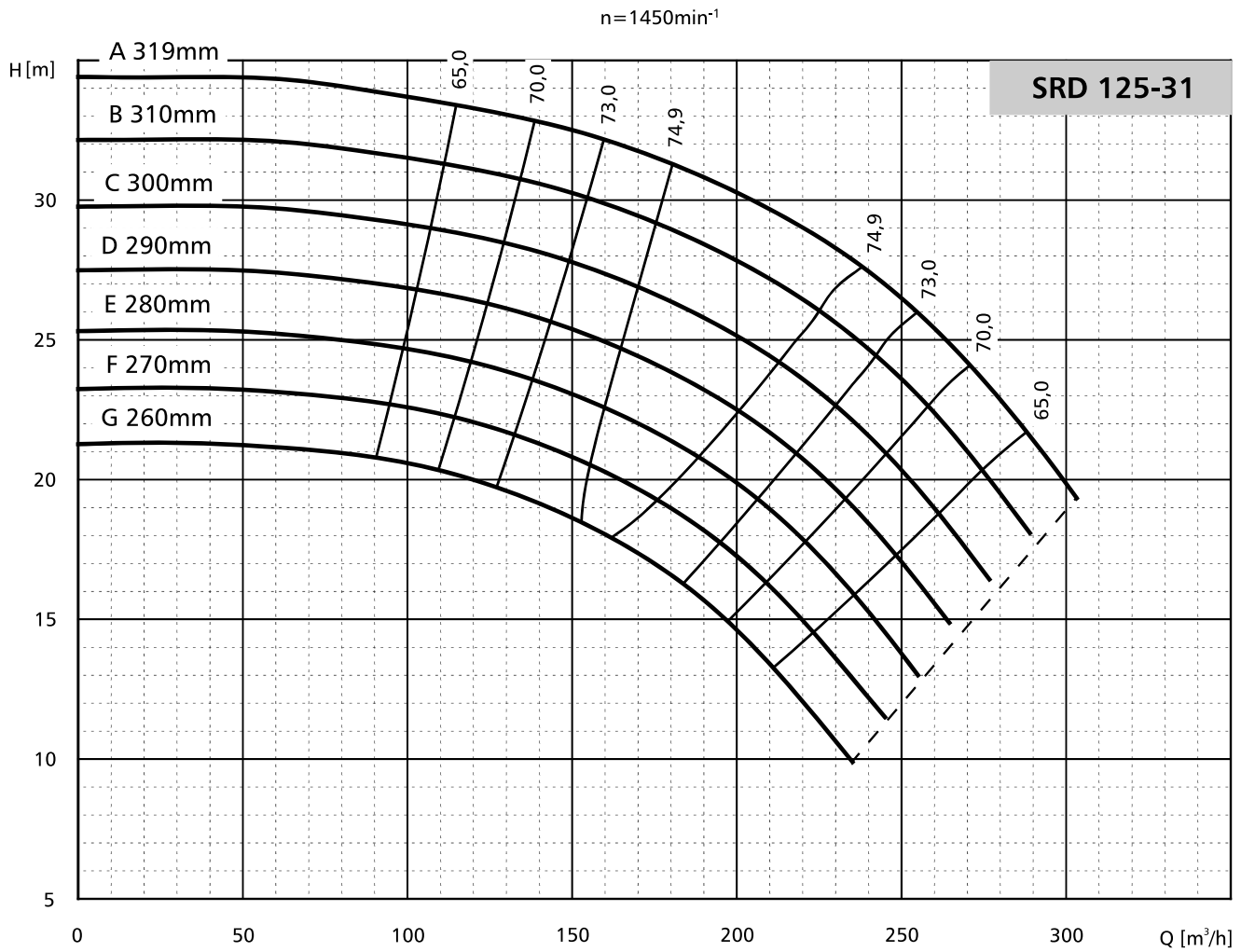

$n=1450\text{min}^{-1}$

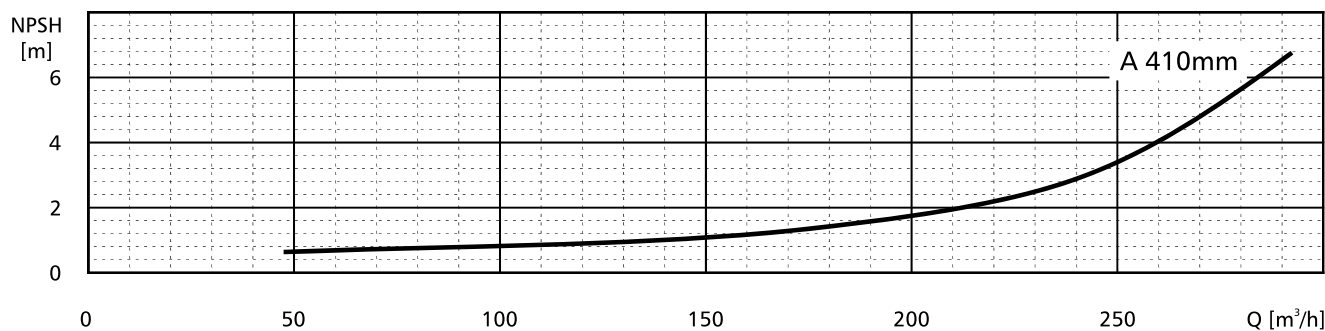
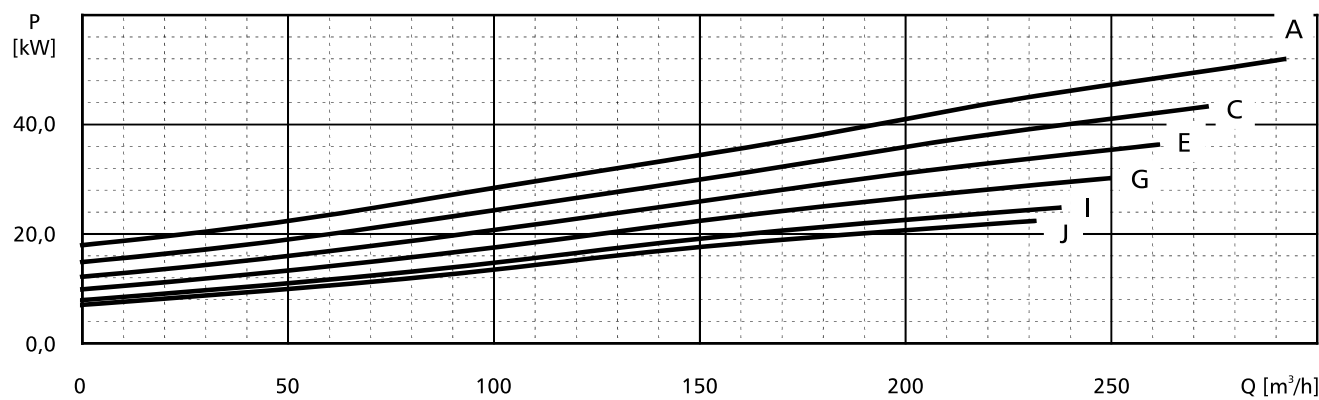
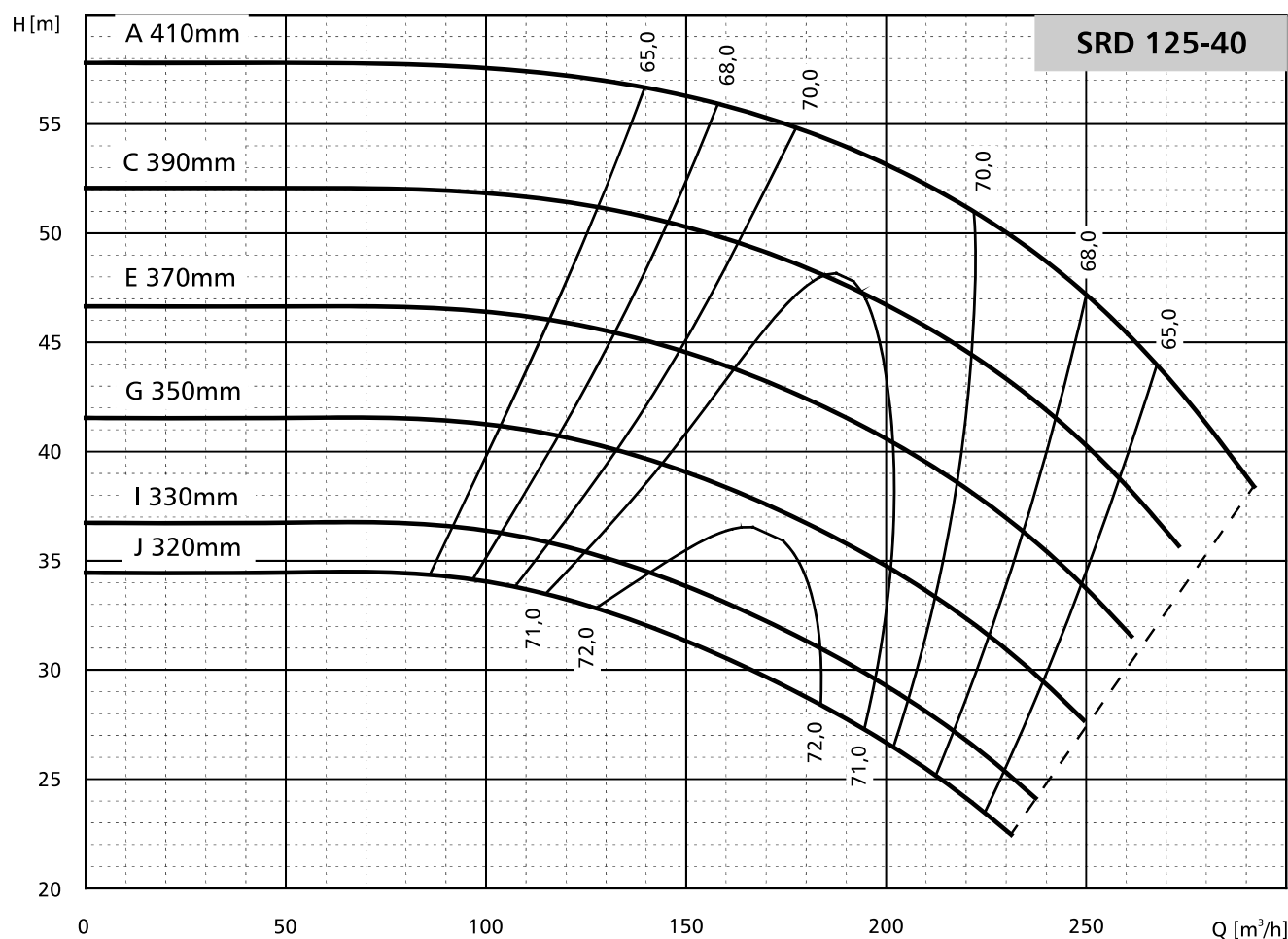

POMPY SPECJALISTYCZNE

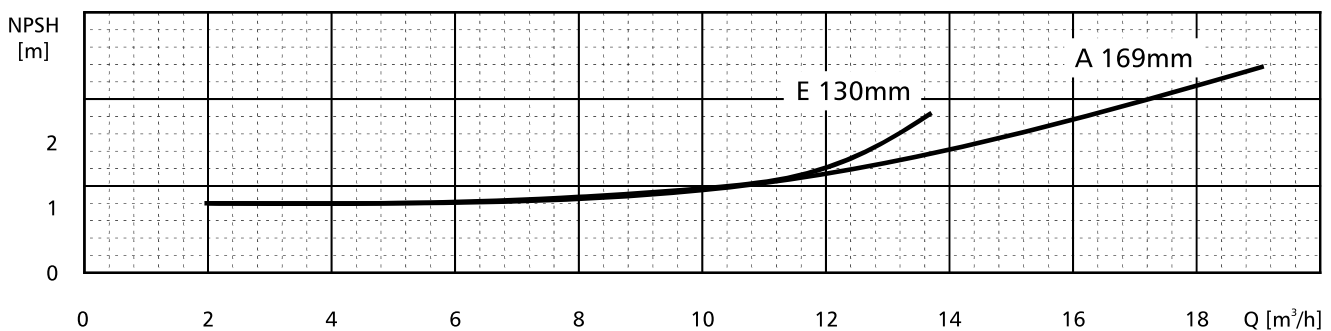
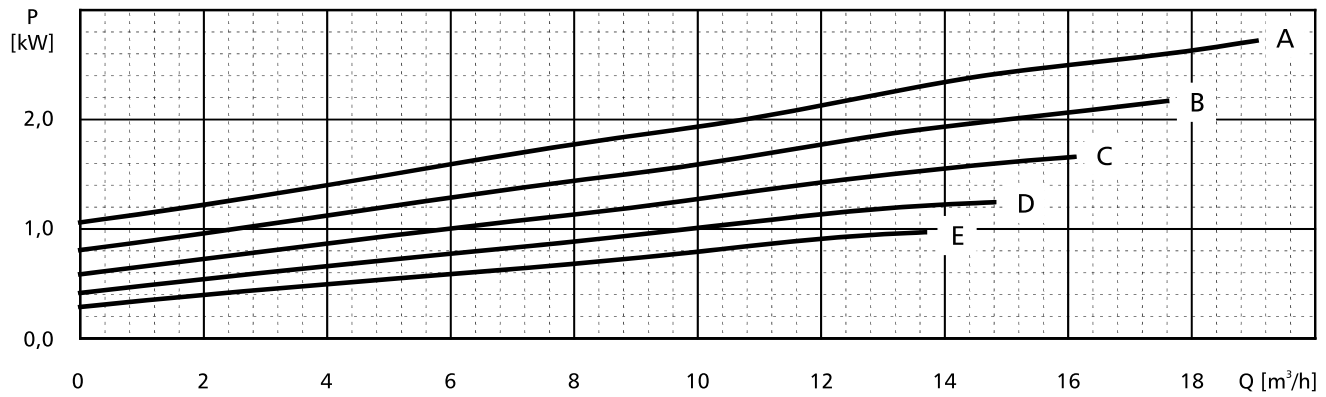
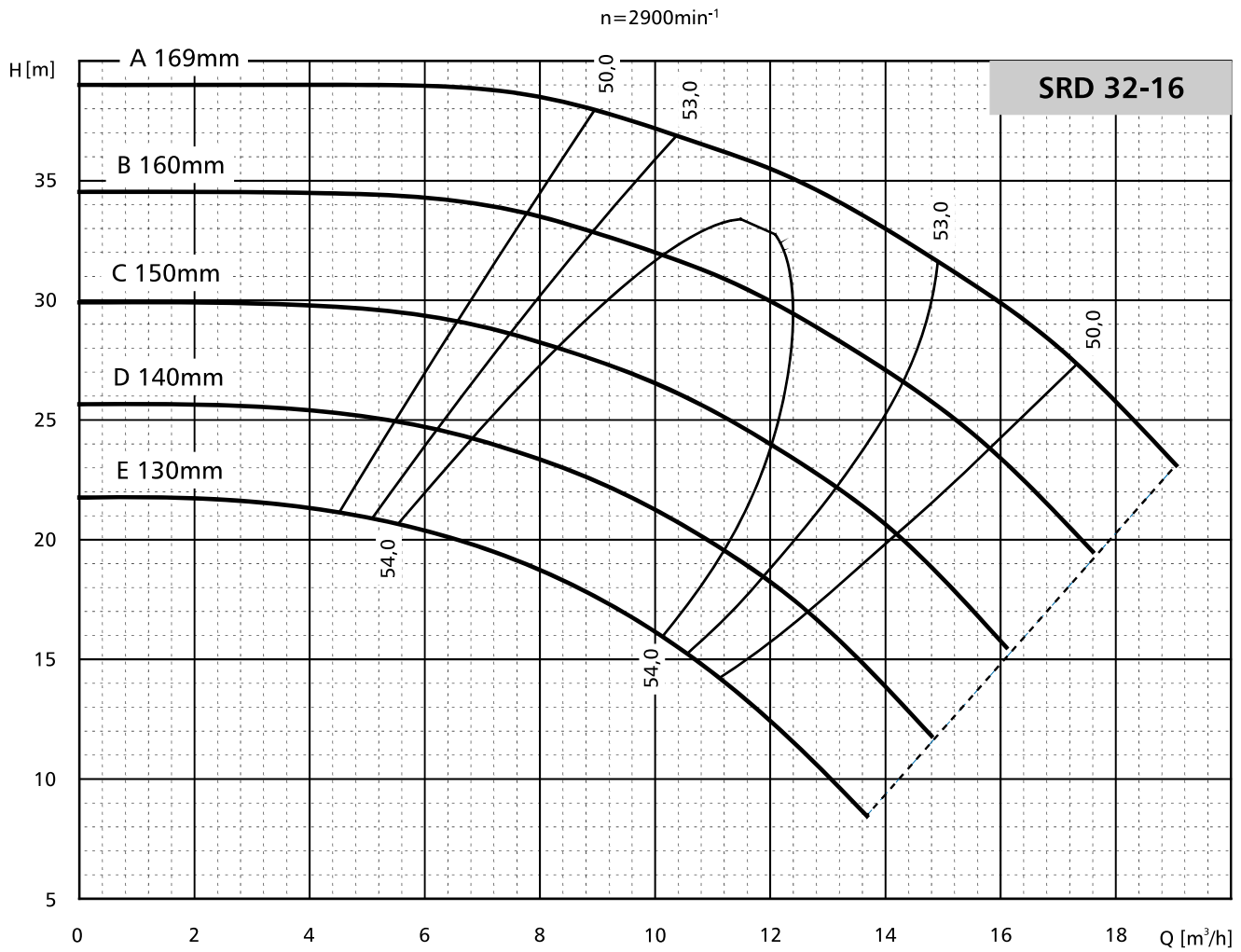

$n=2900\text{min}^{-1}$

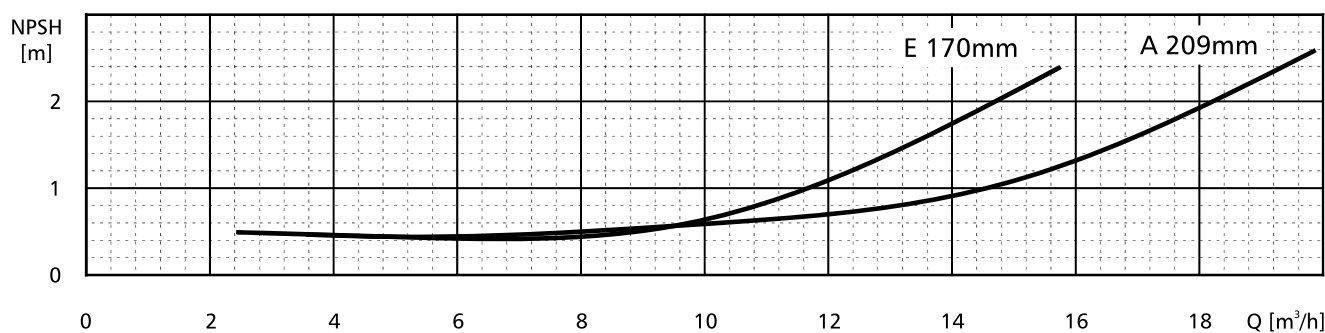
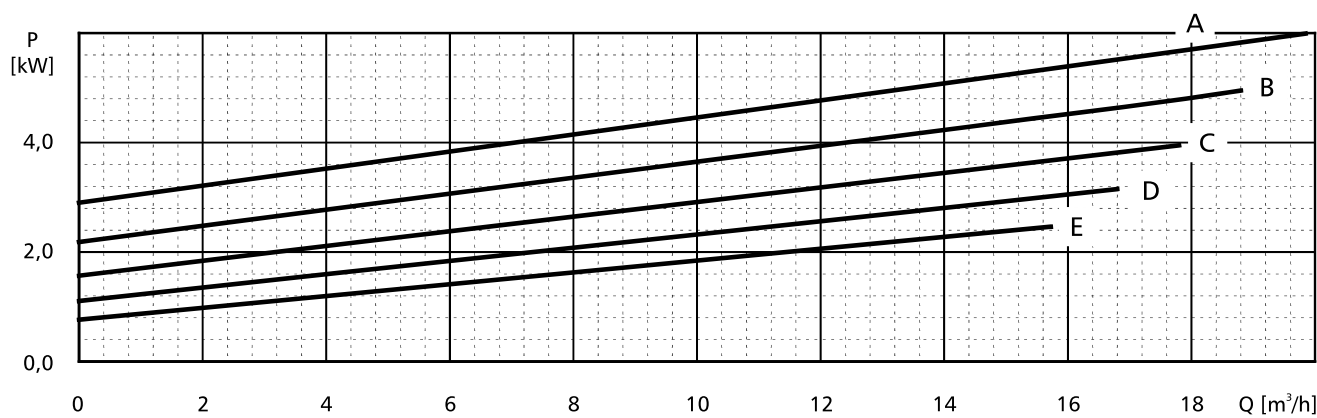
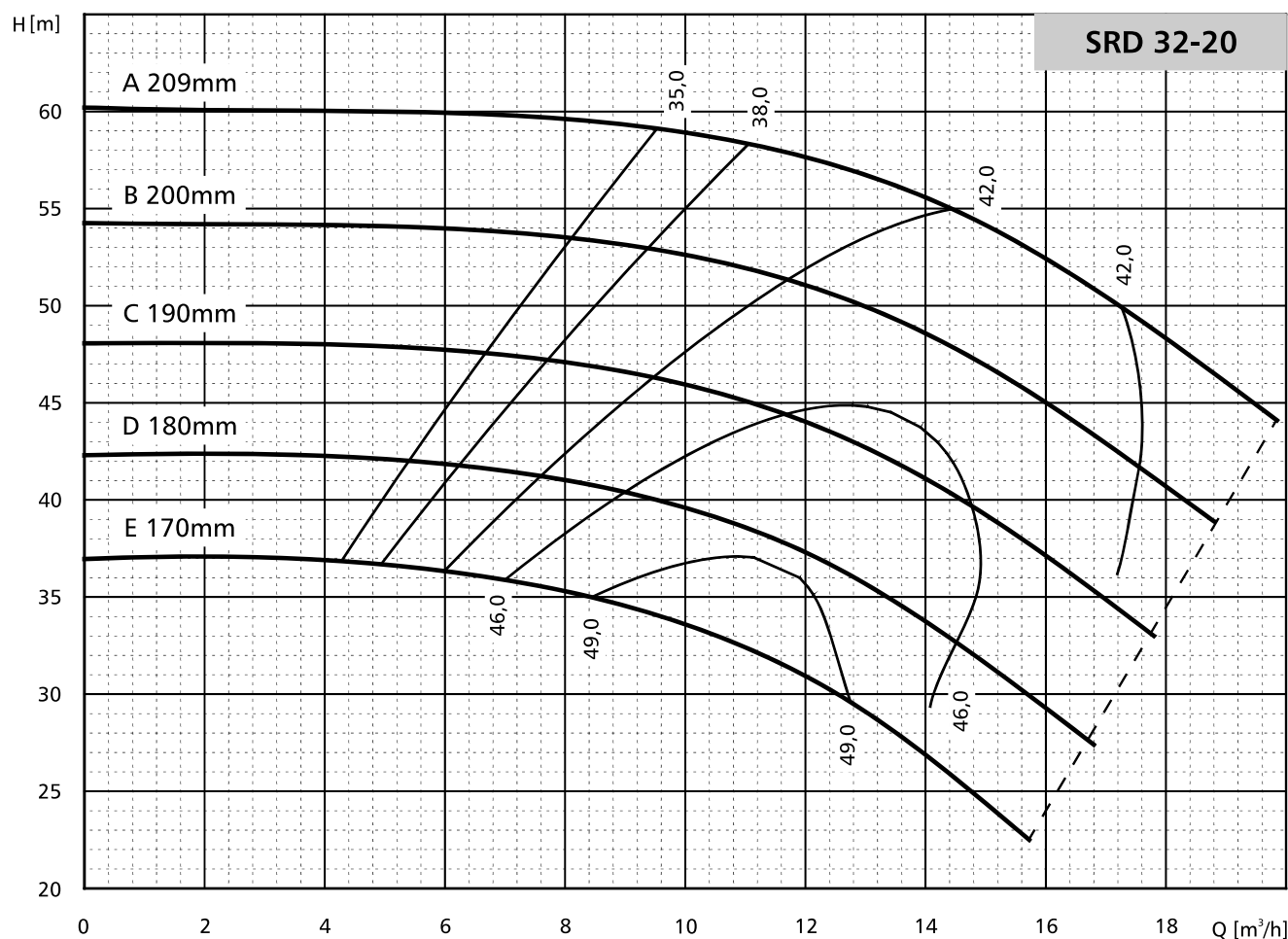

$n=2900\text{min}^{-1}$

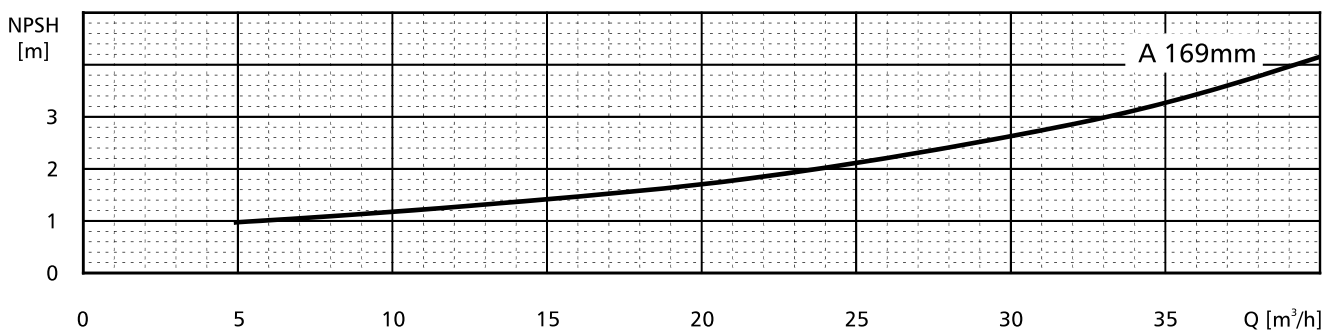
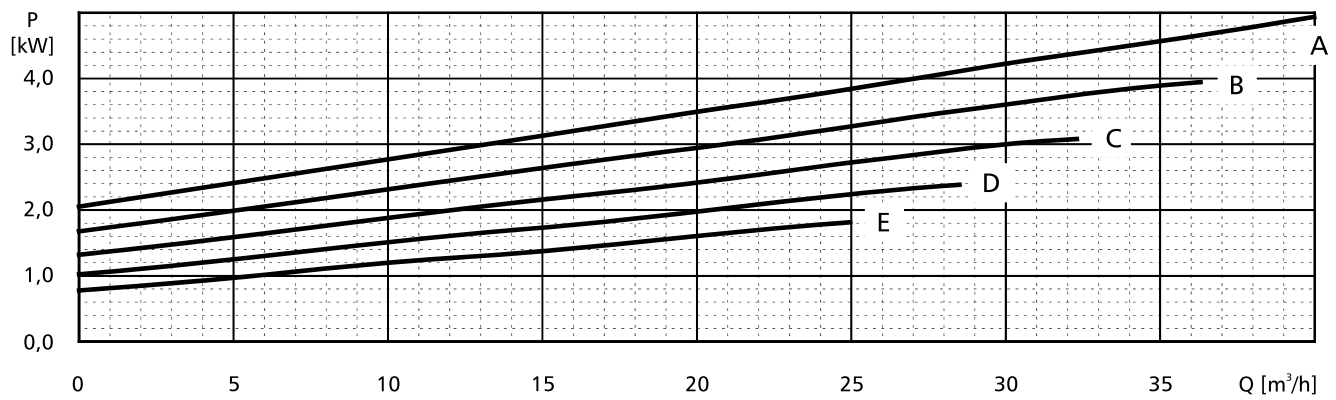
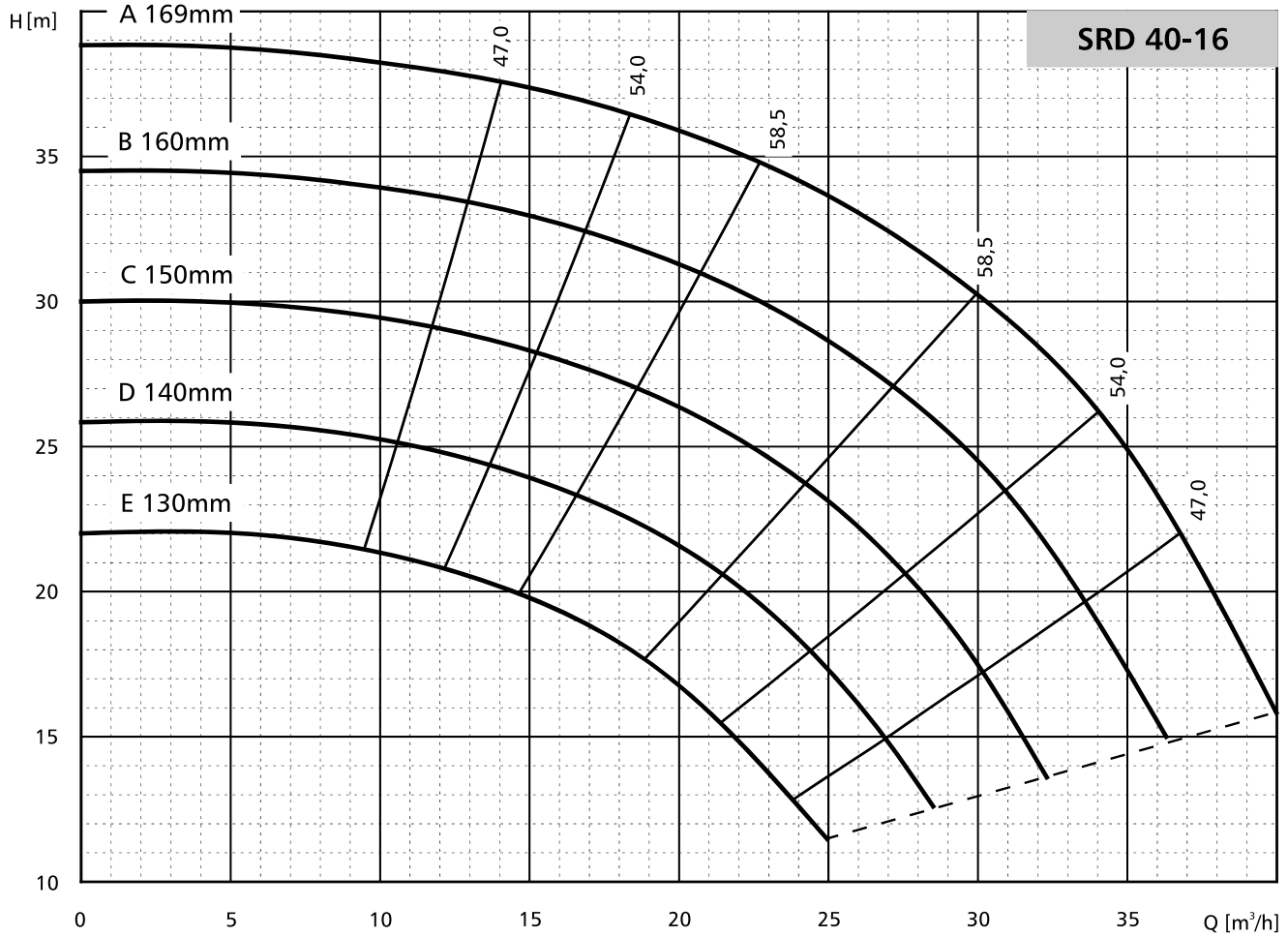

n=2900min⁻¹

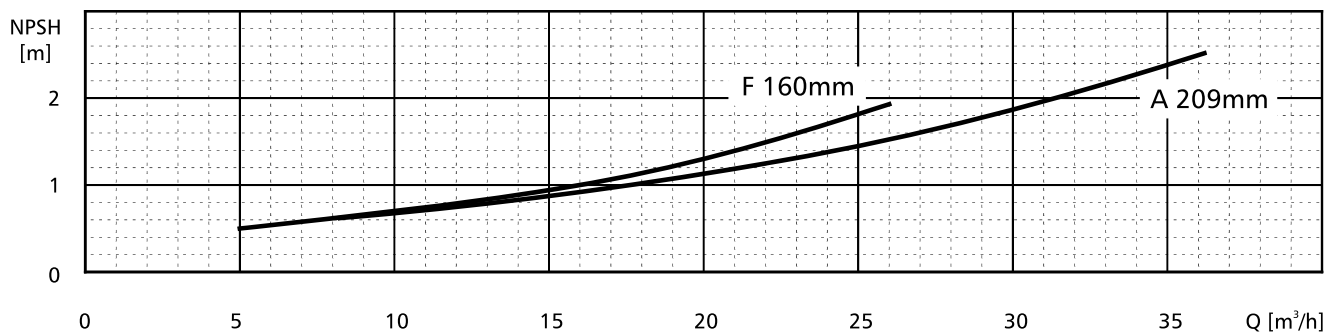
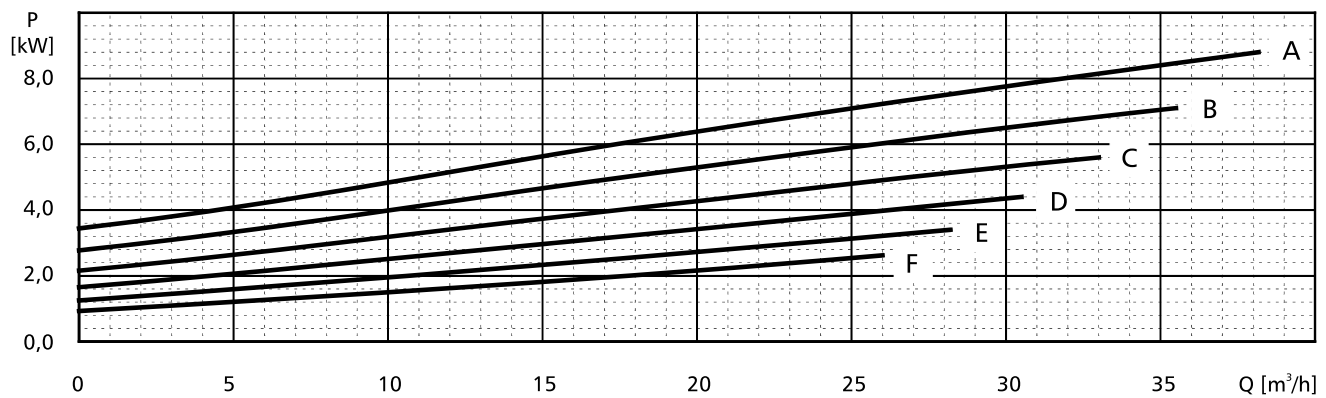
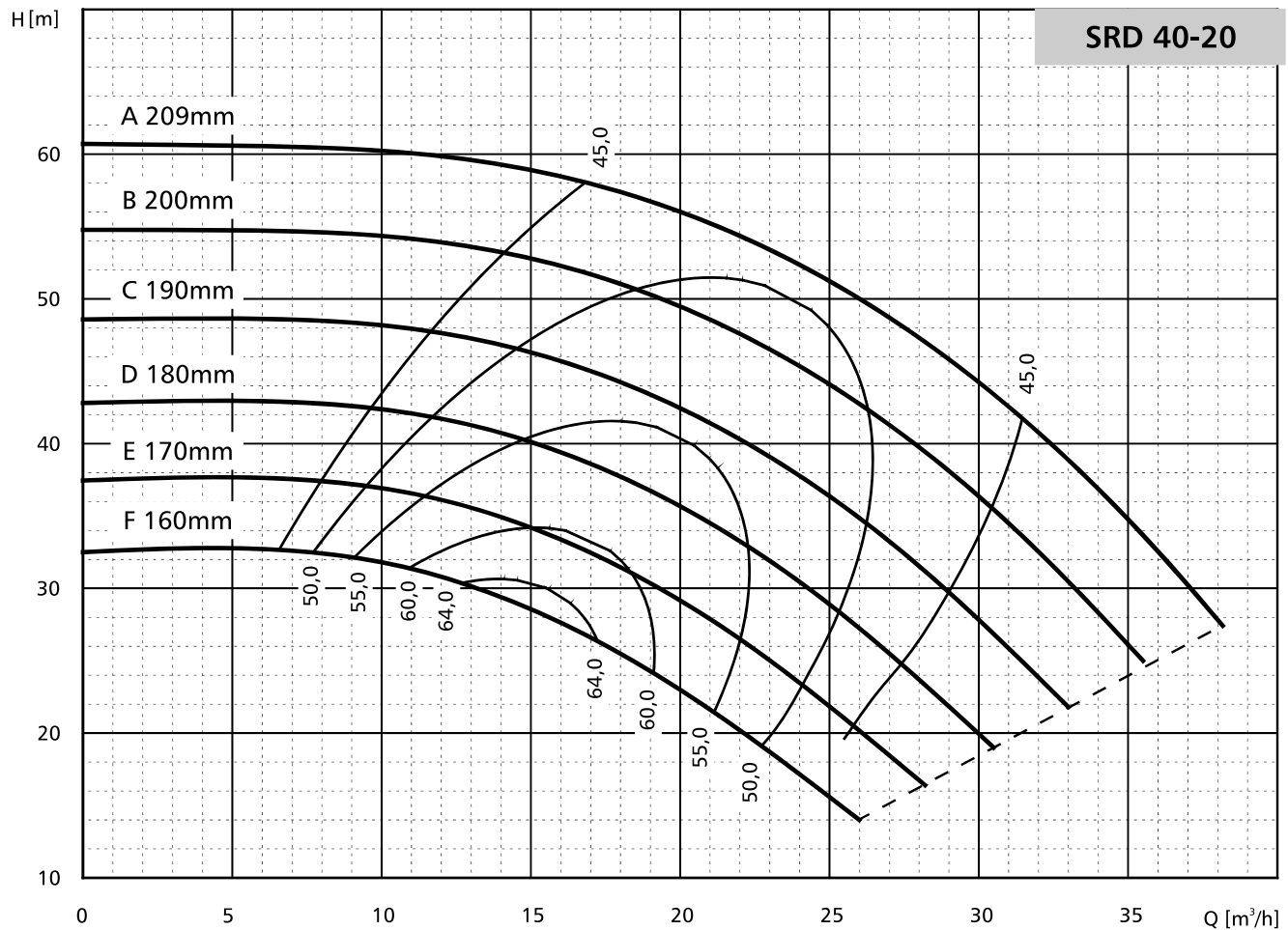

$n=2900\text{min}^{-1}$

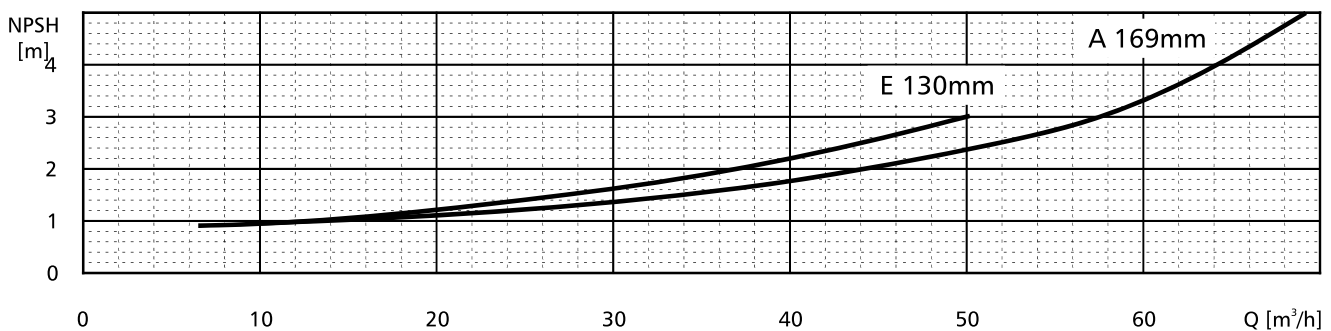
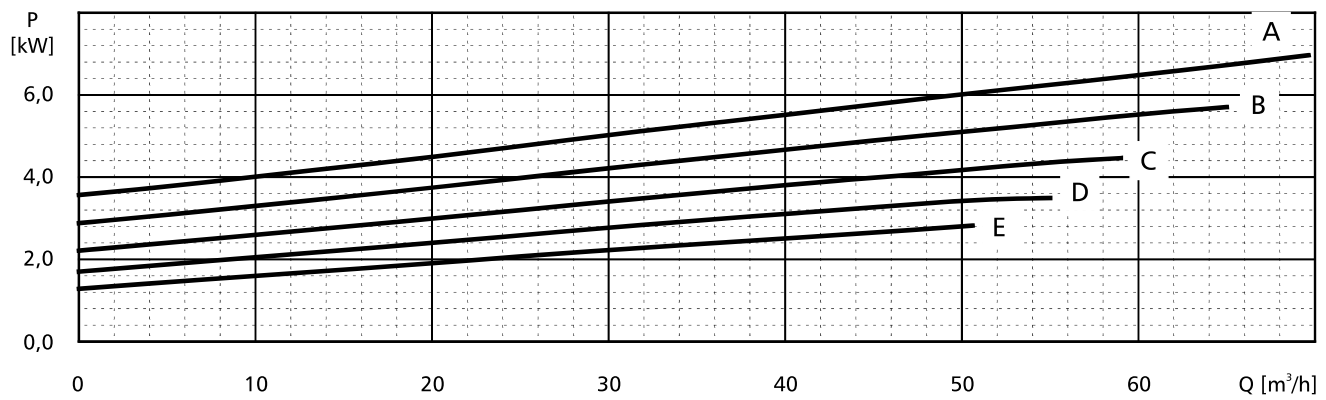
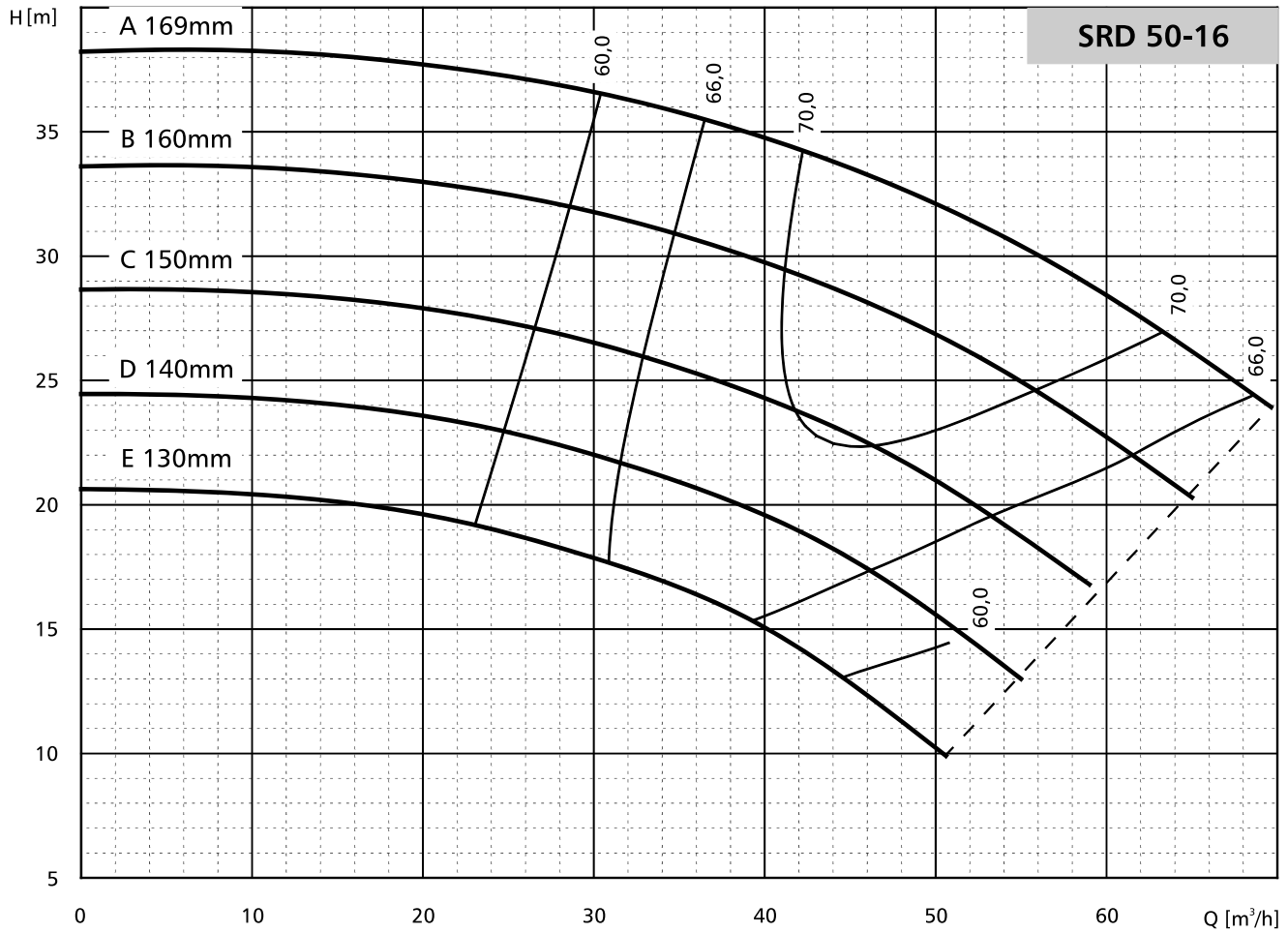

$n=2900\text{min}^{-1}$

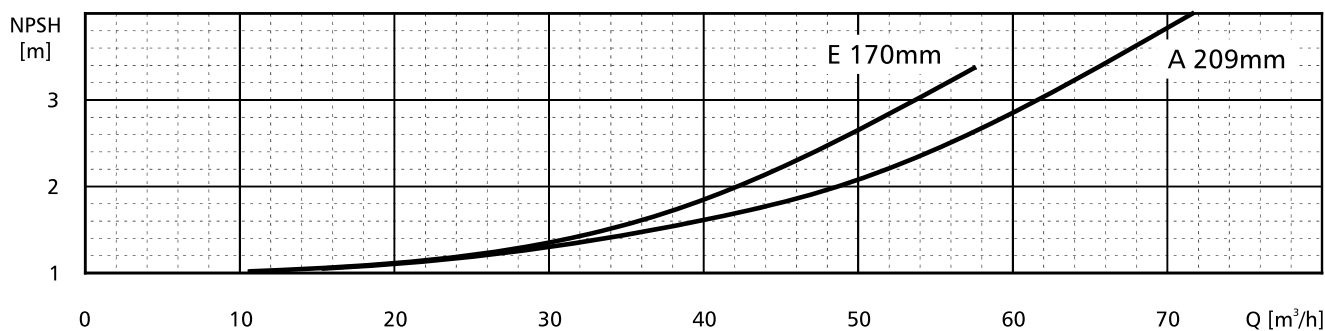
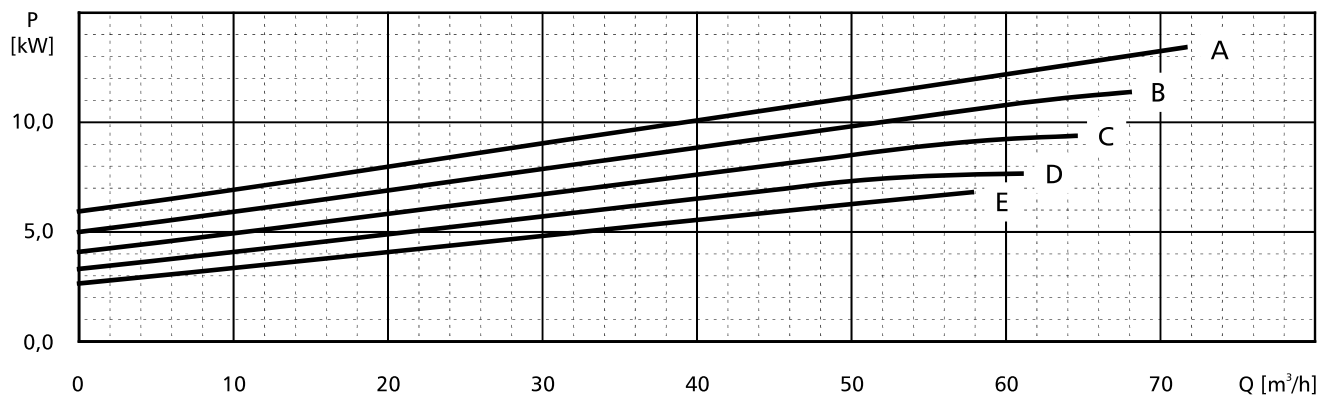
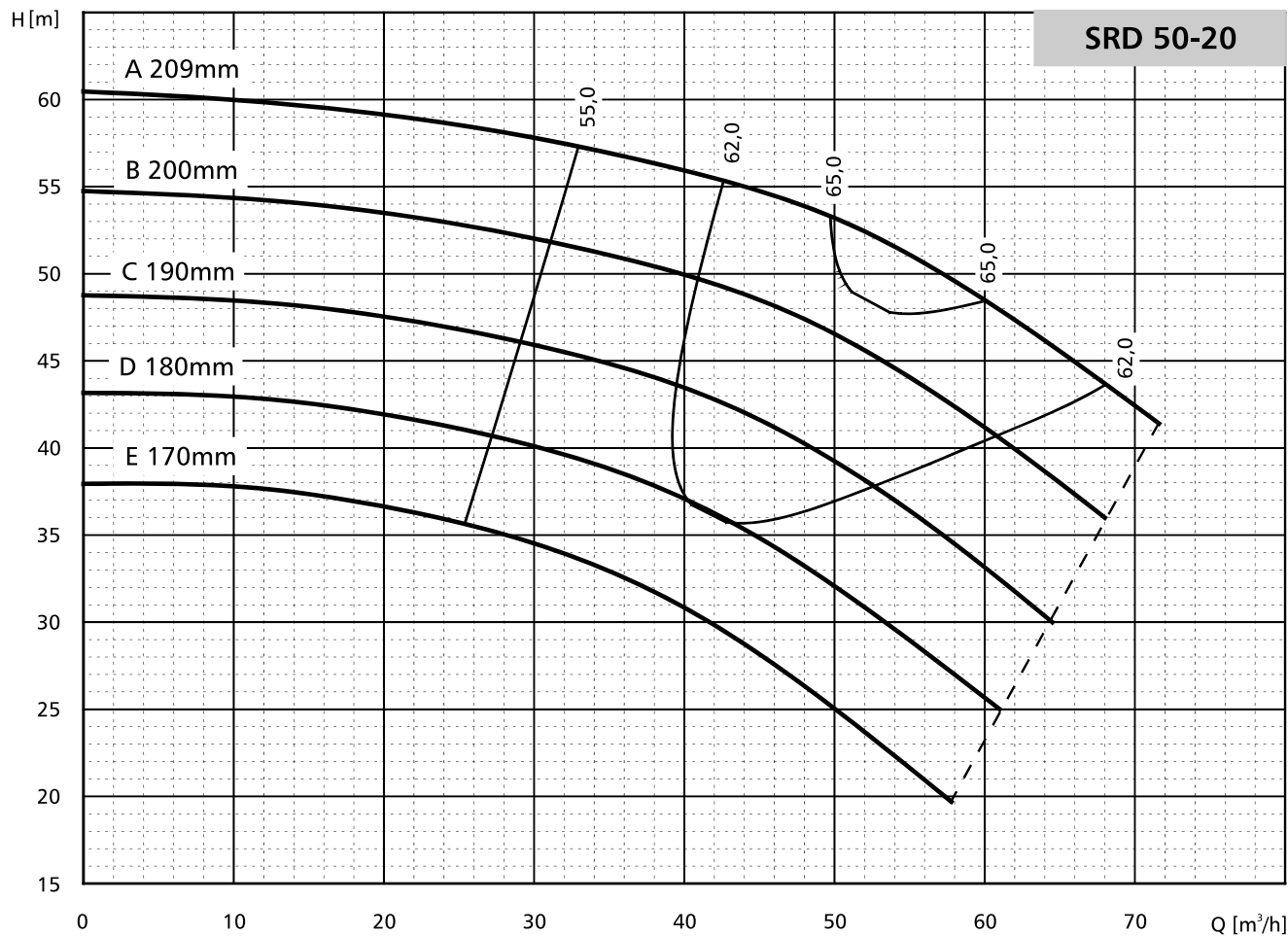

$n=2900\text{min}^{-1}$

SRD 50-25

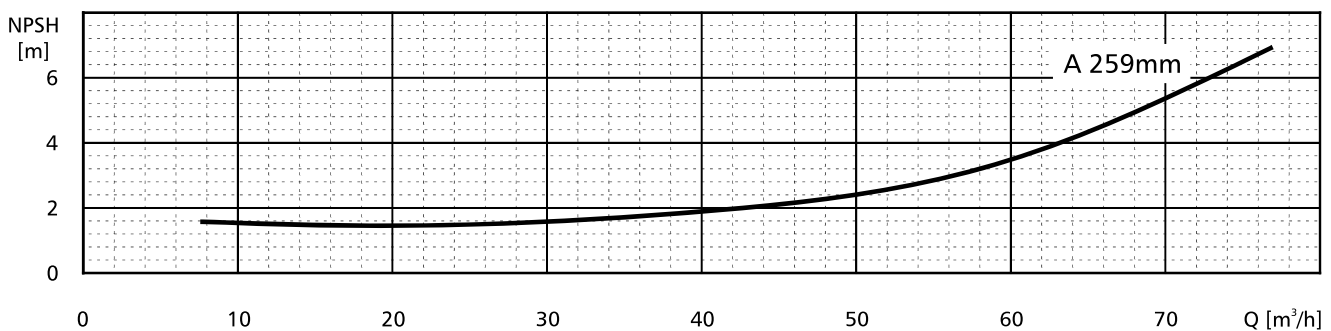
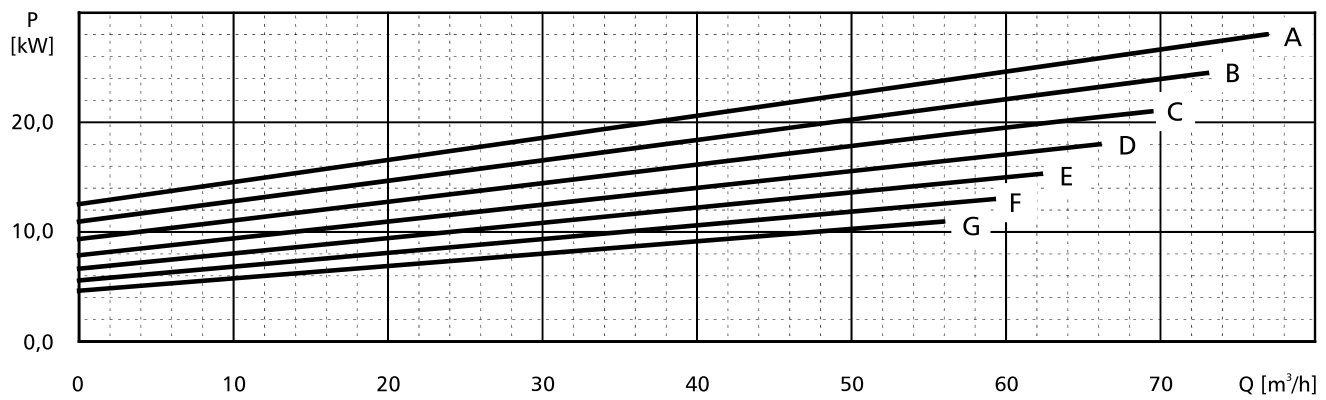
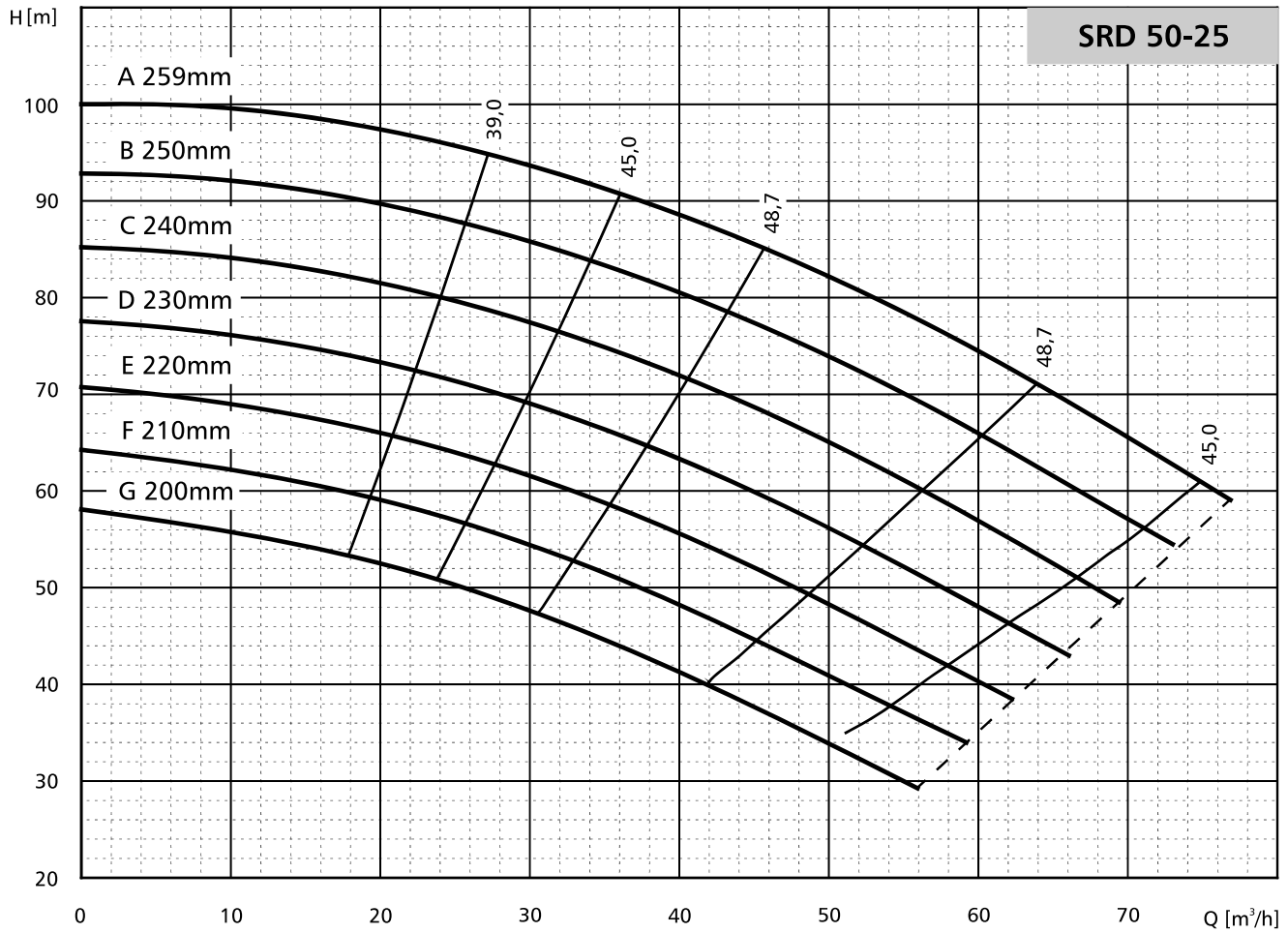

$n=2900\text{min}^{-1}$

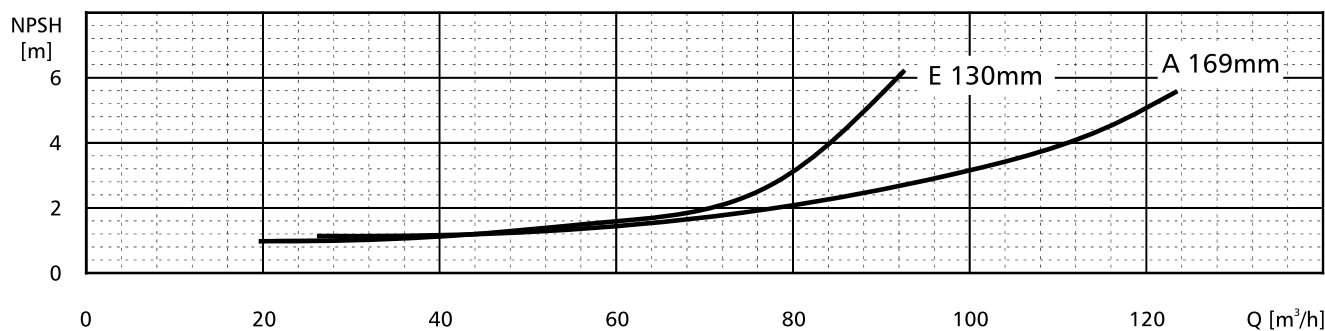
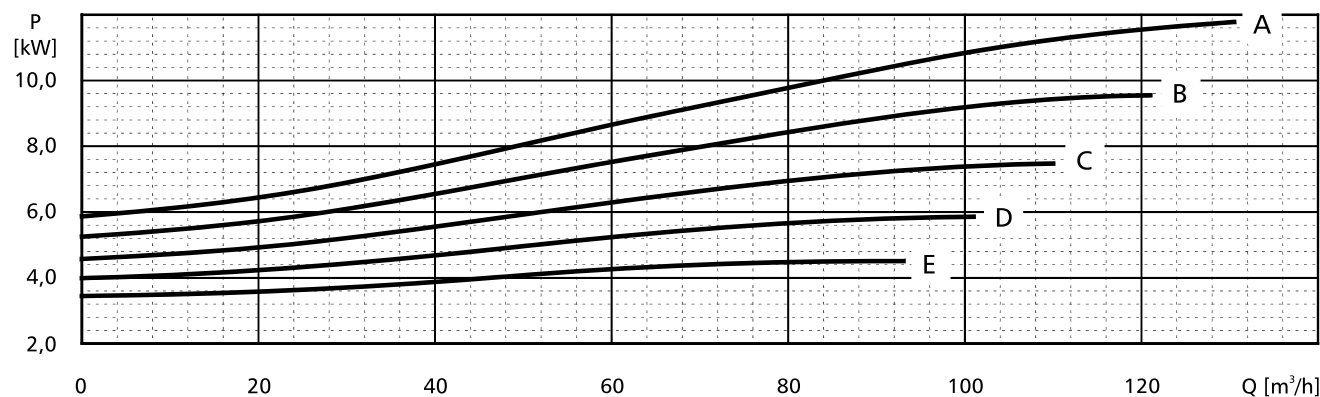
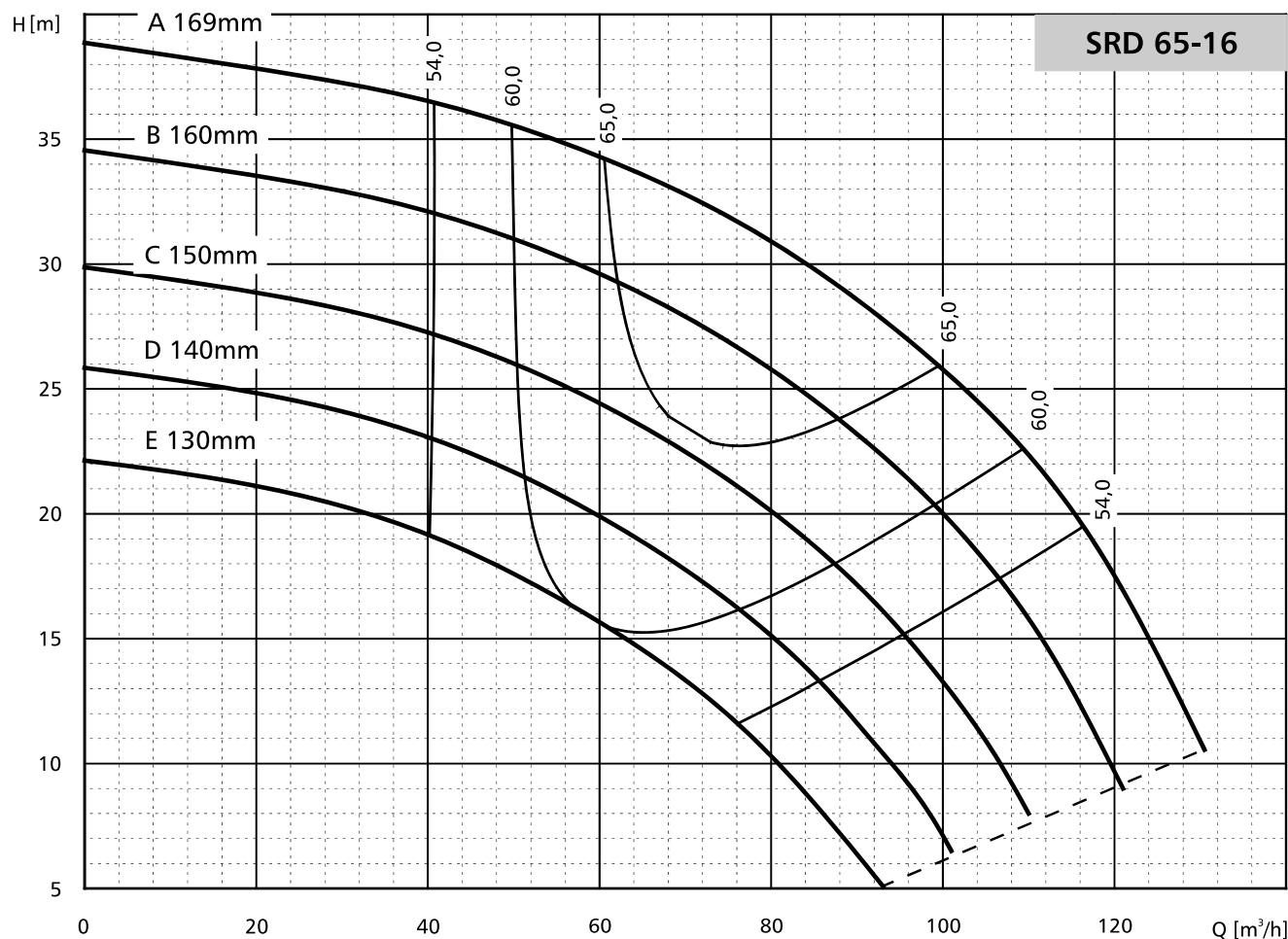

$n=2900\text{min}^{-1}$

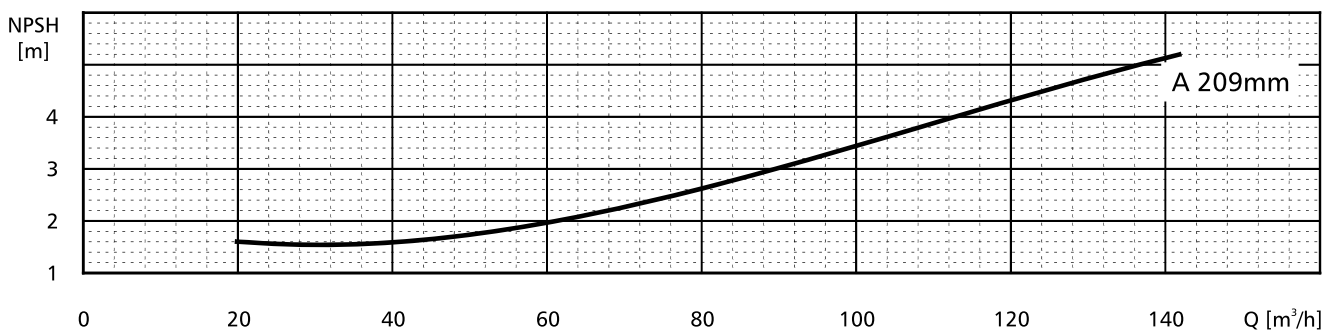
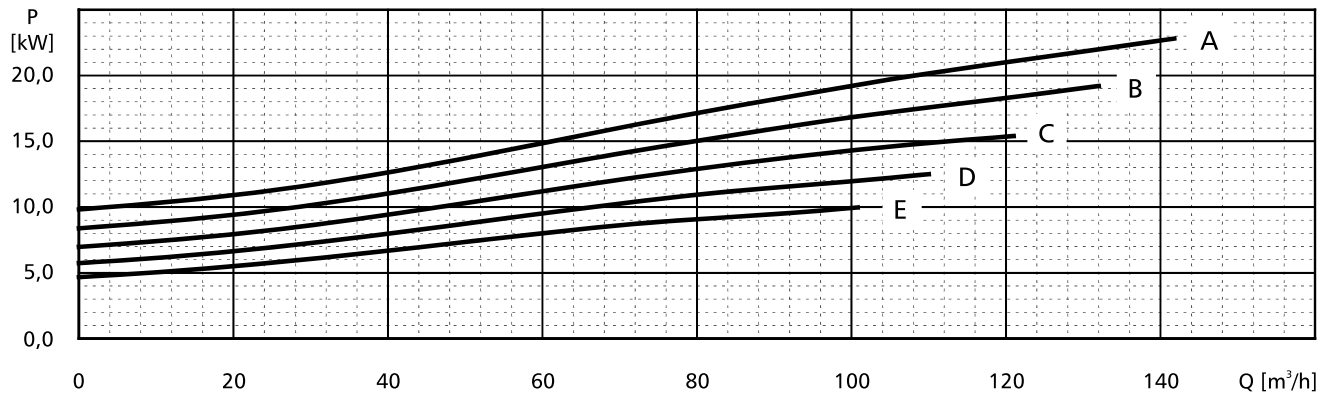
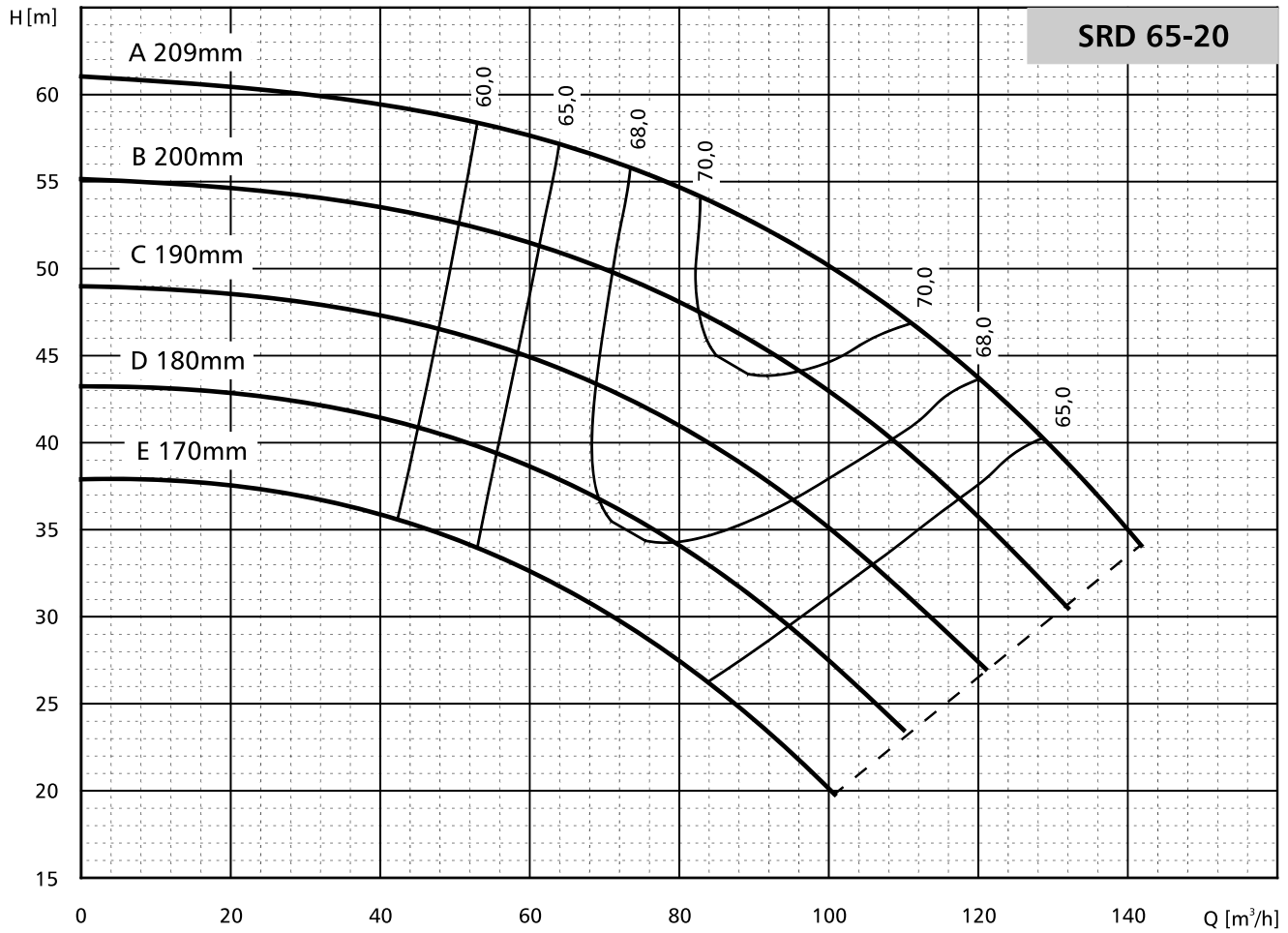

$n=2900\text{min}^{-1}$

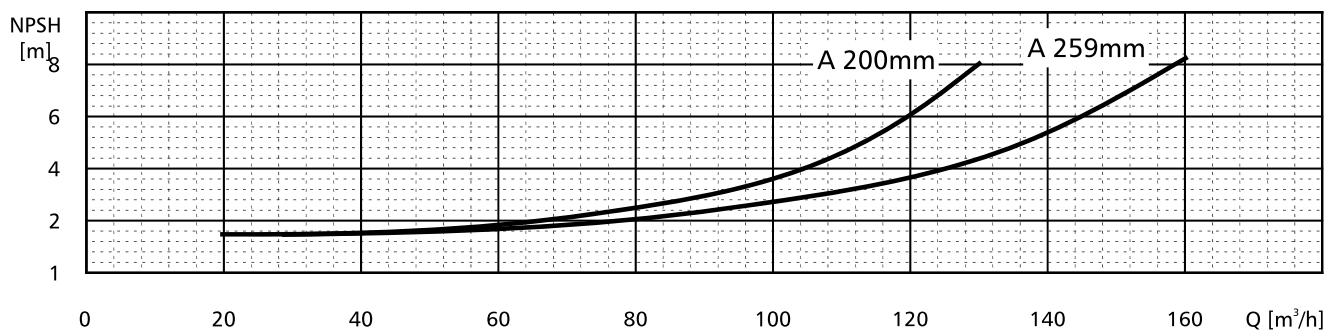
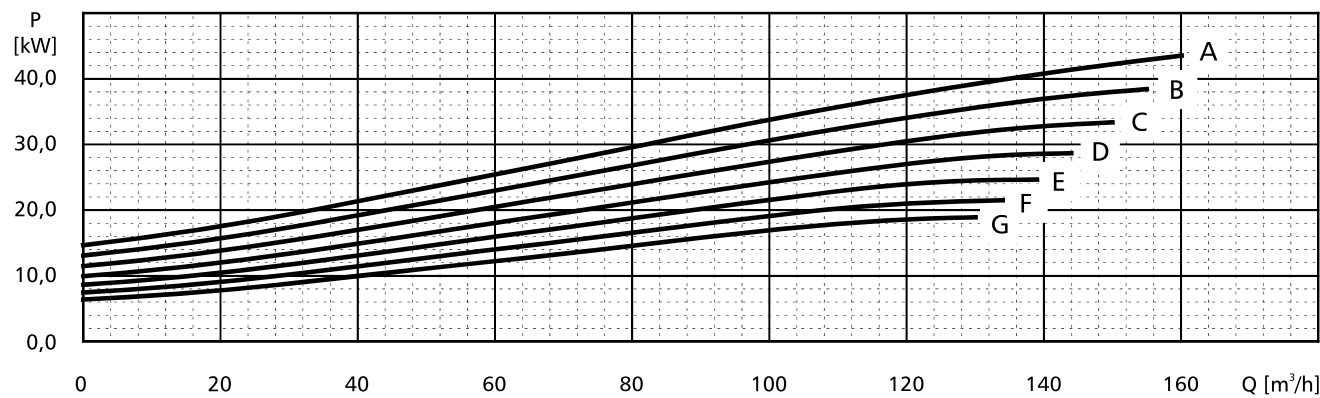
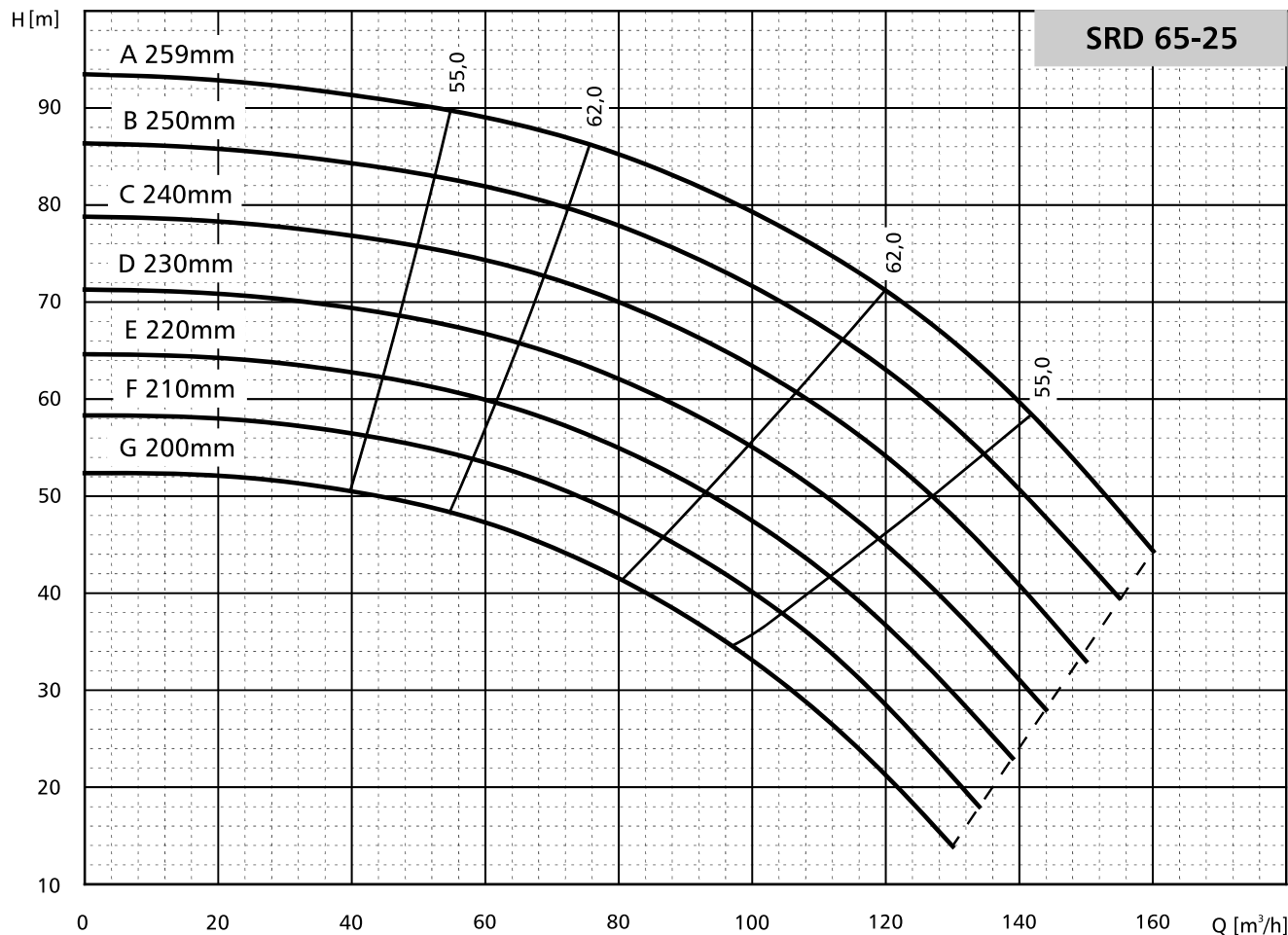

POMPY SPECJALISTYCZNE

$n=2900\text{min}^{-1}$

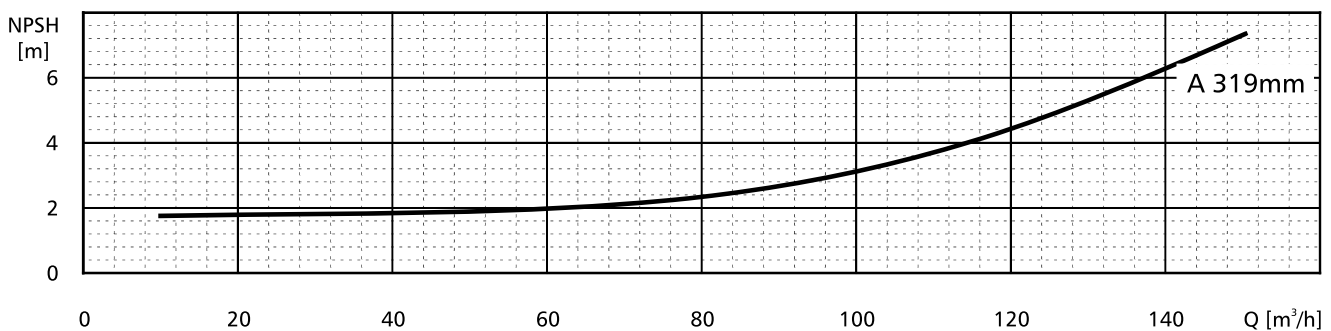
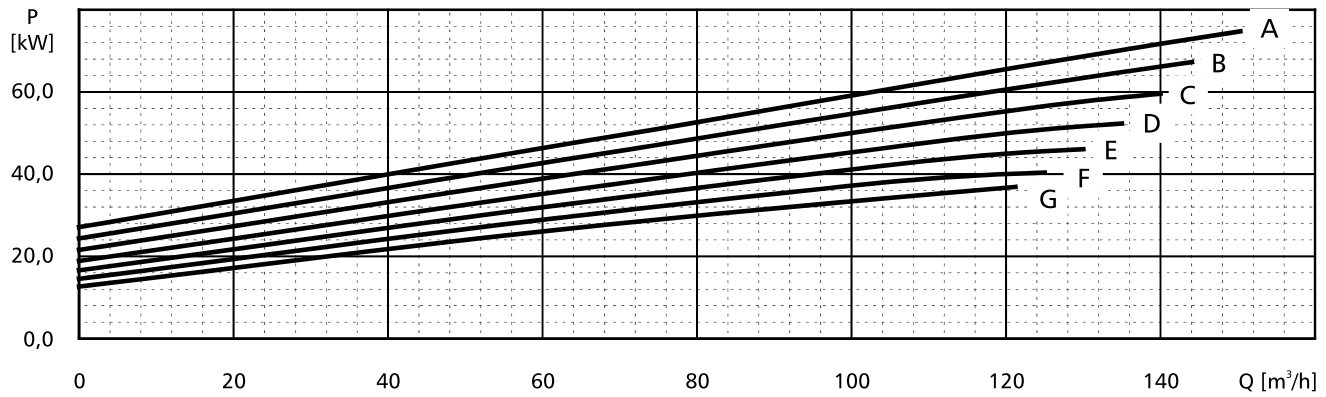
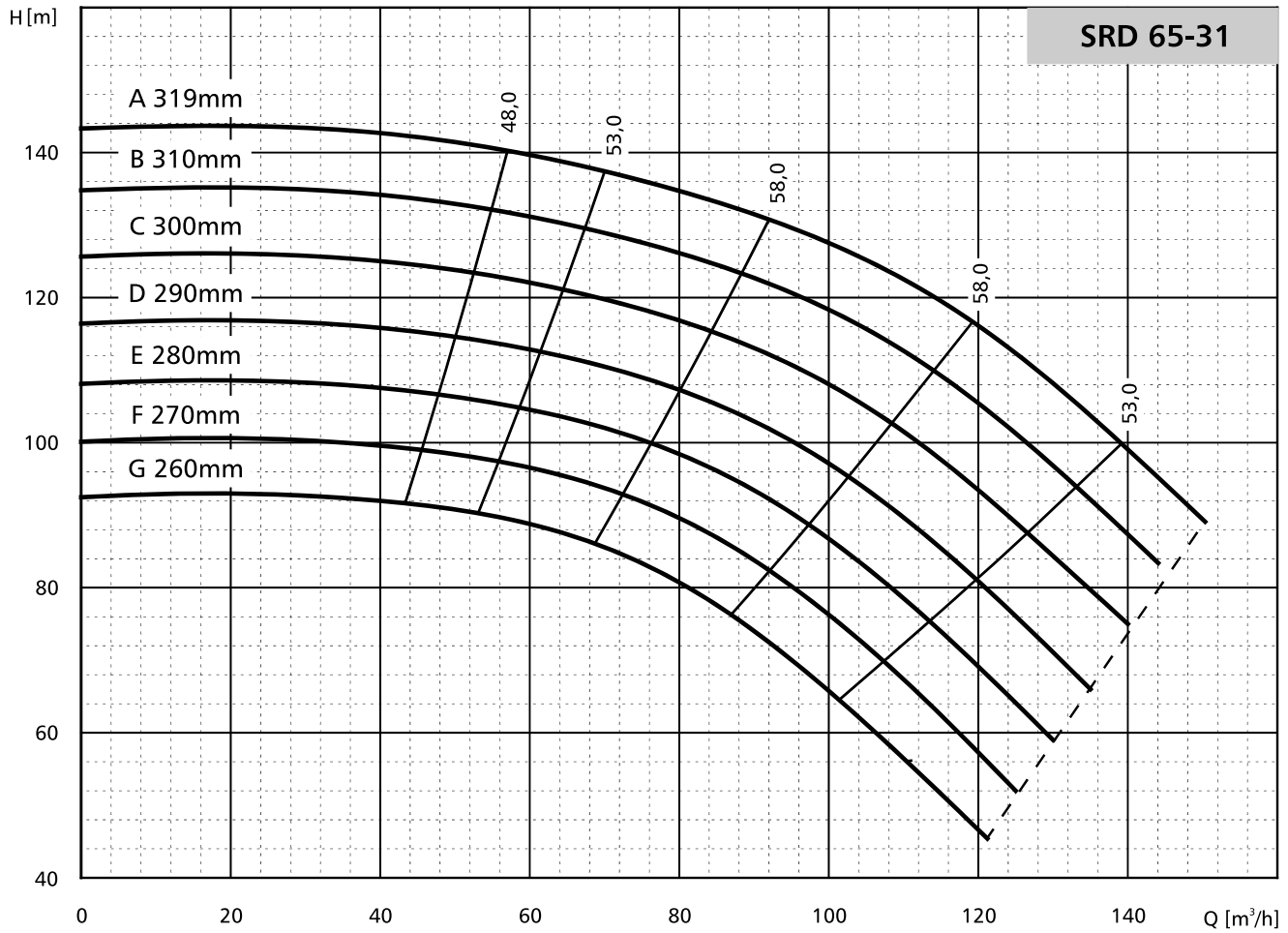

$n=2900\text{min}^{-1}$

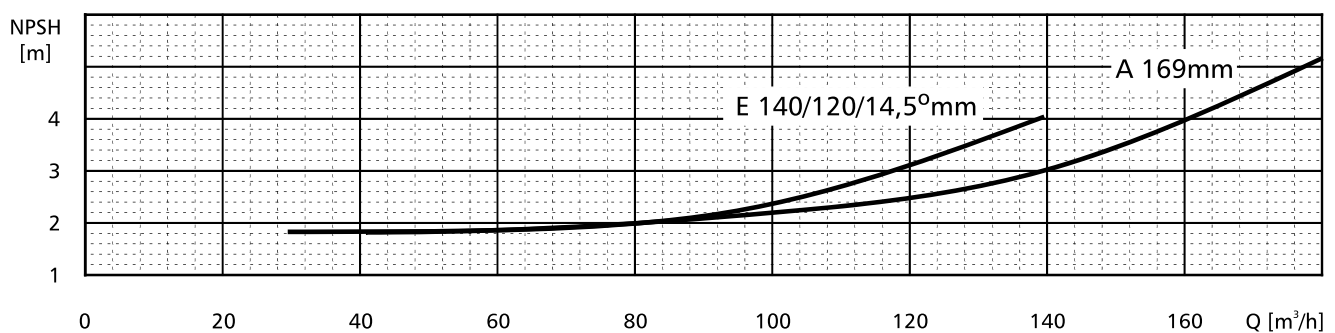
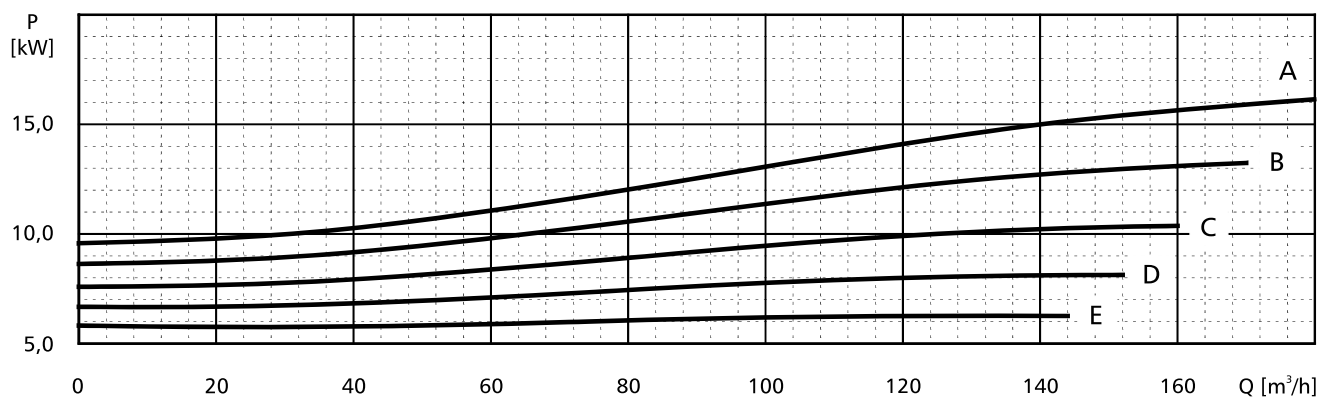
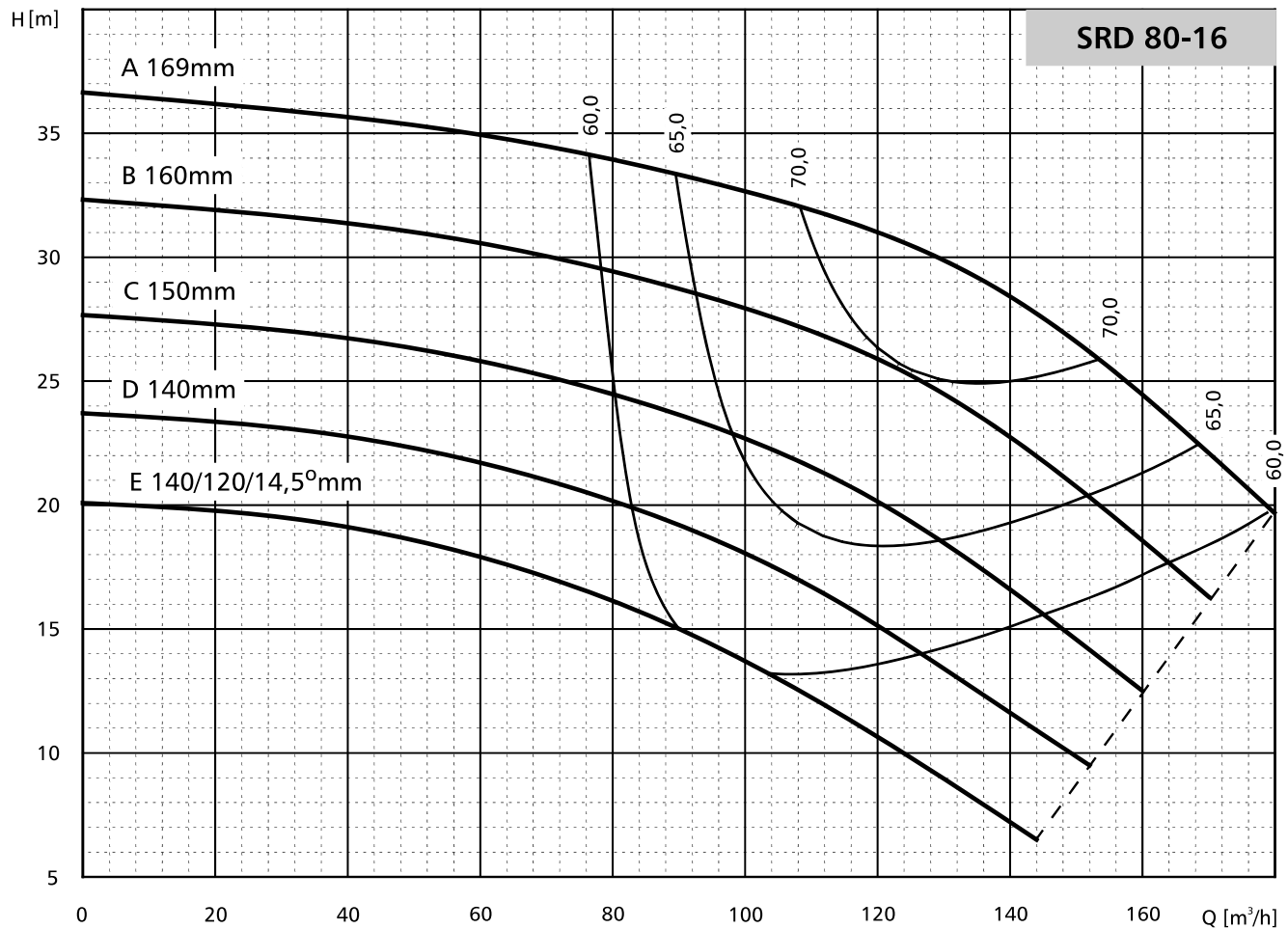

$n=2900\text{min}^{-1}$

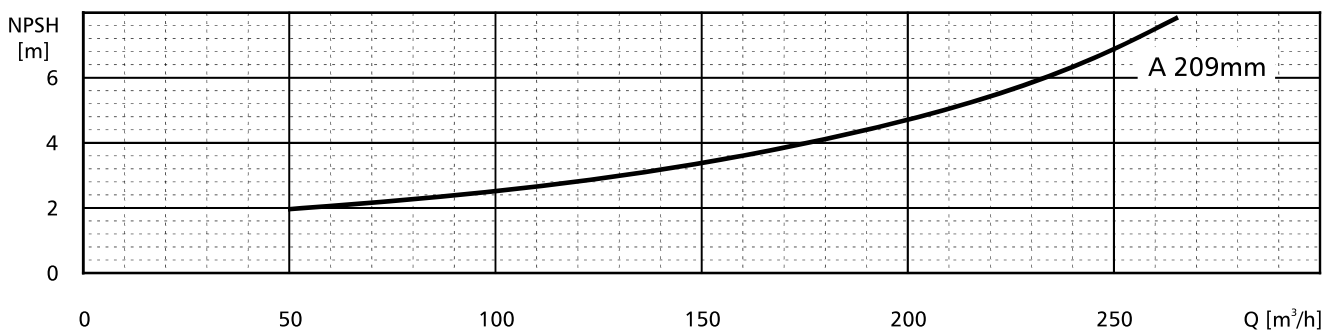
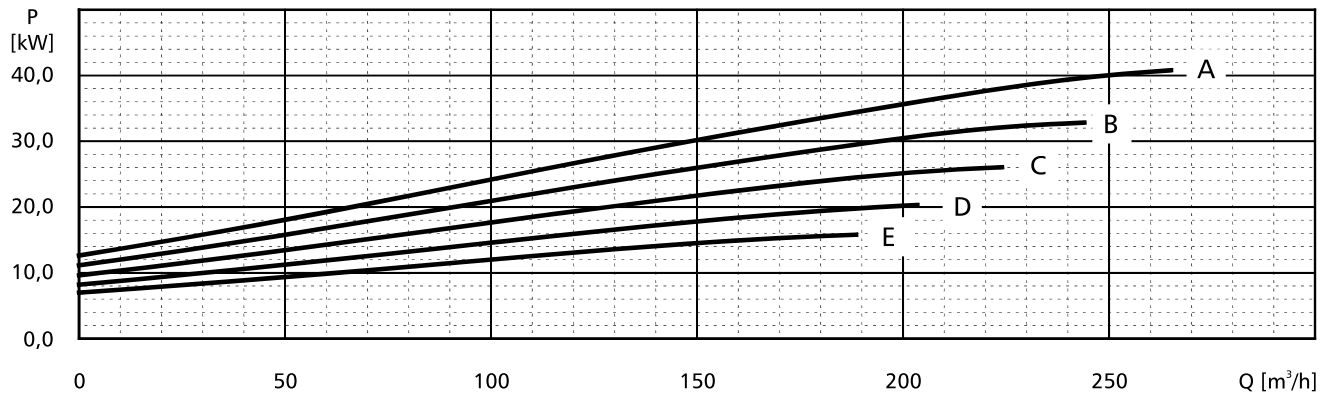
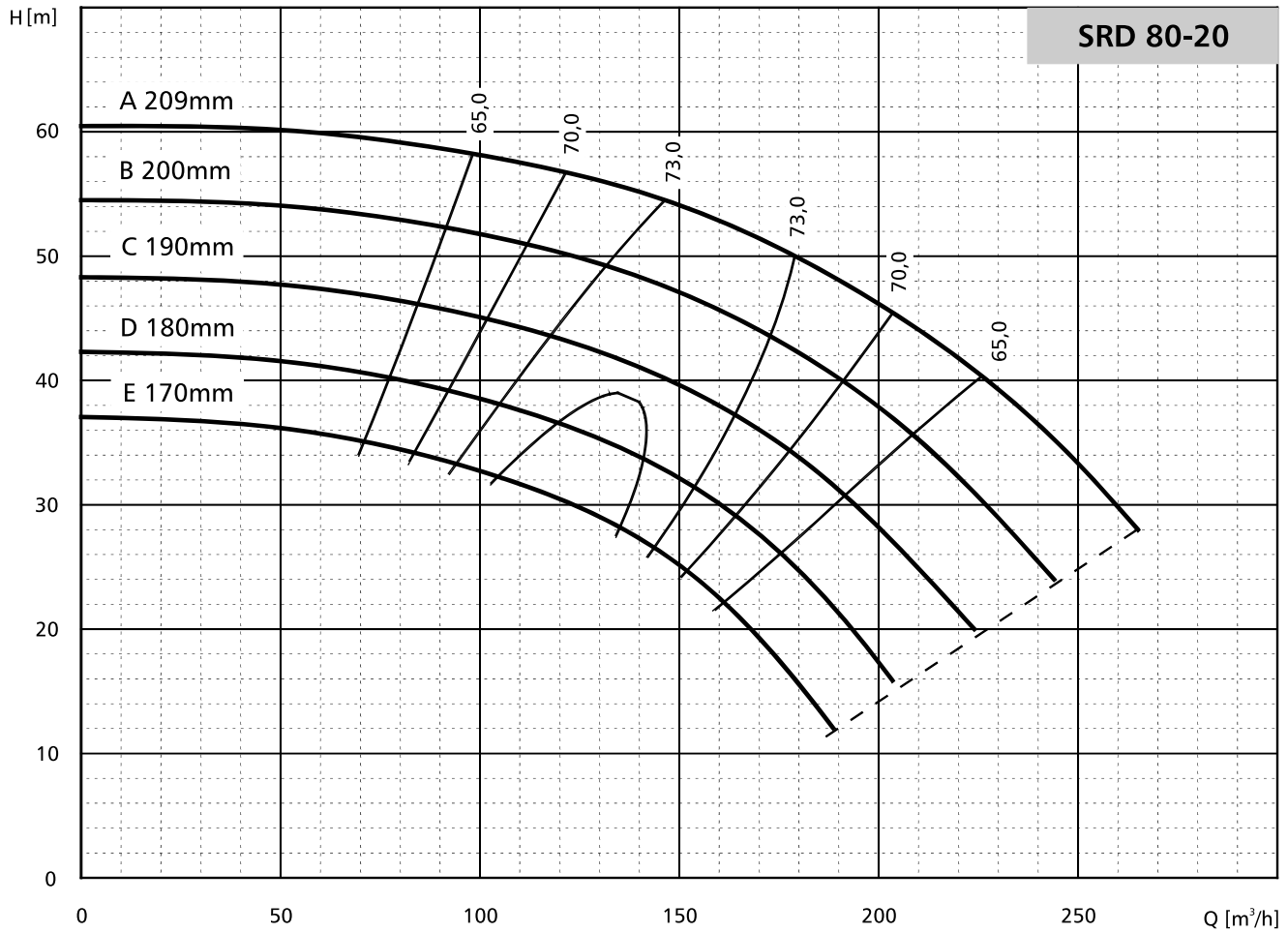

$n=2900\text{min}^{-1}$

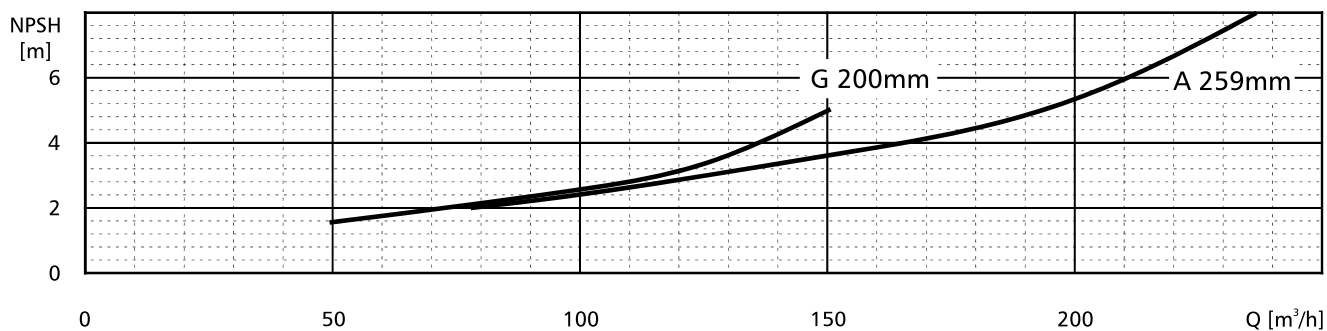
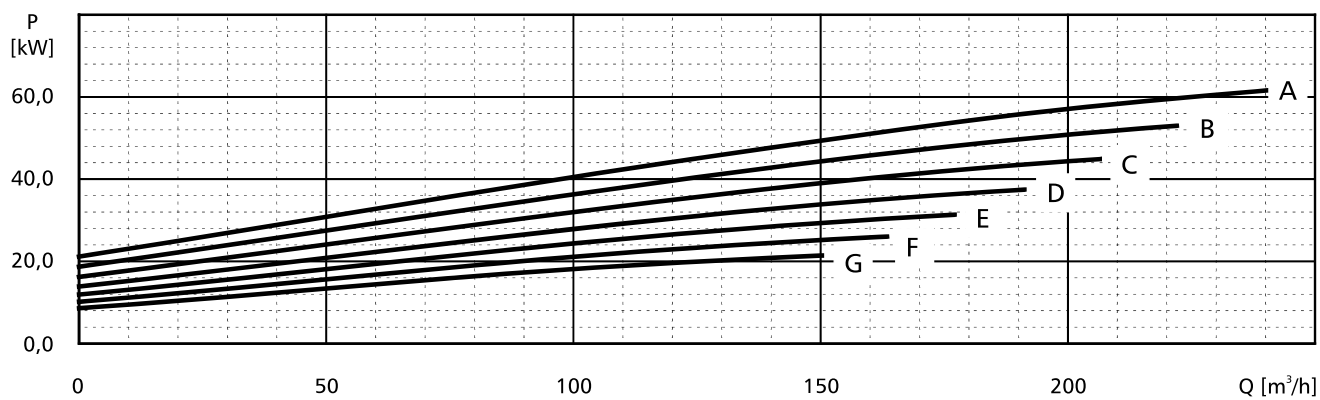
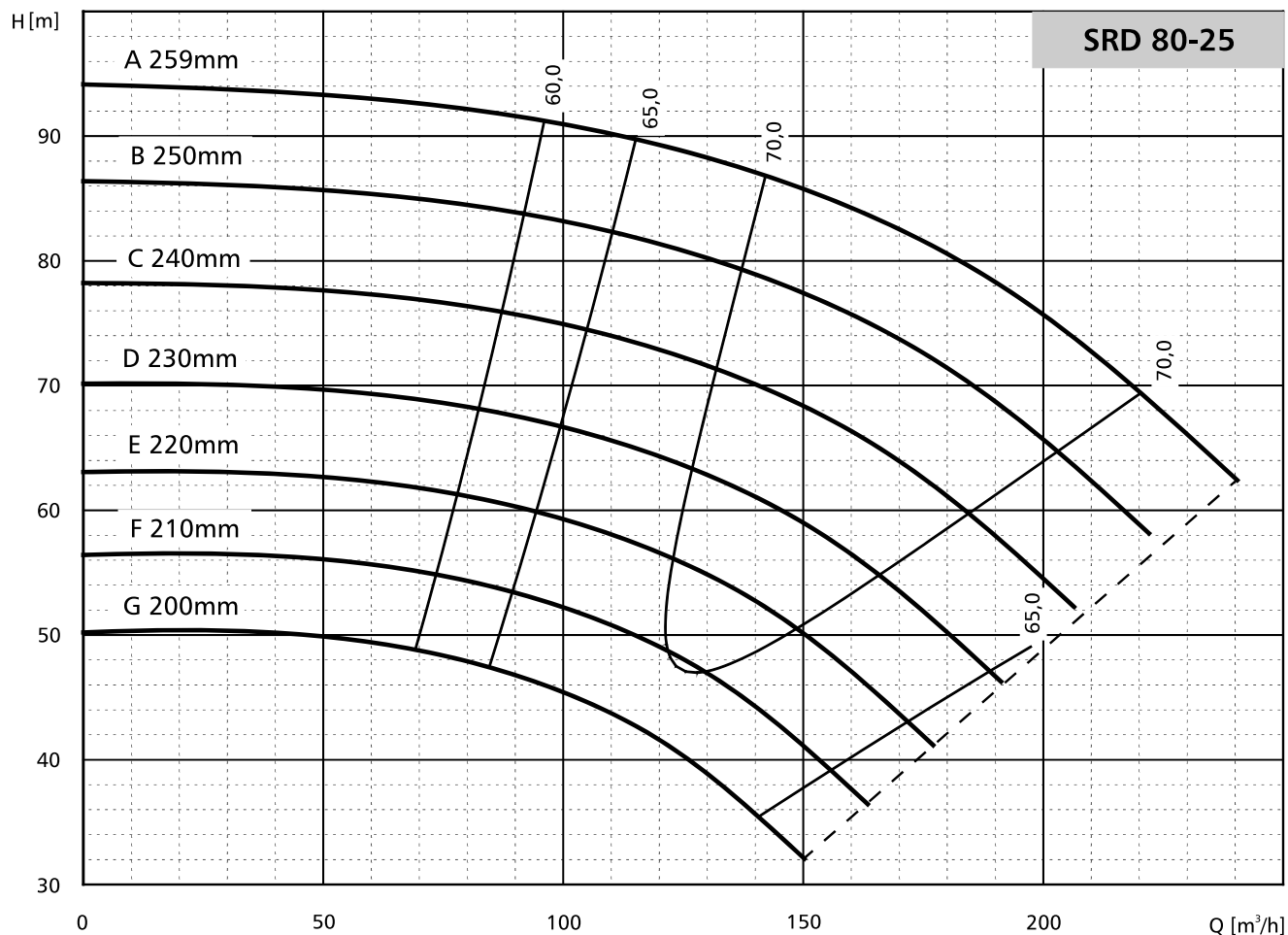

POMPY SPECJALISTYCZNE

$n=2900\text{min}^{-1}$

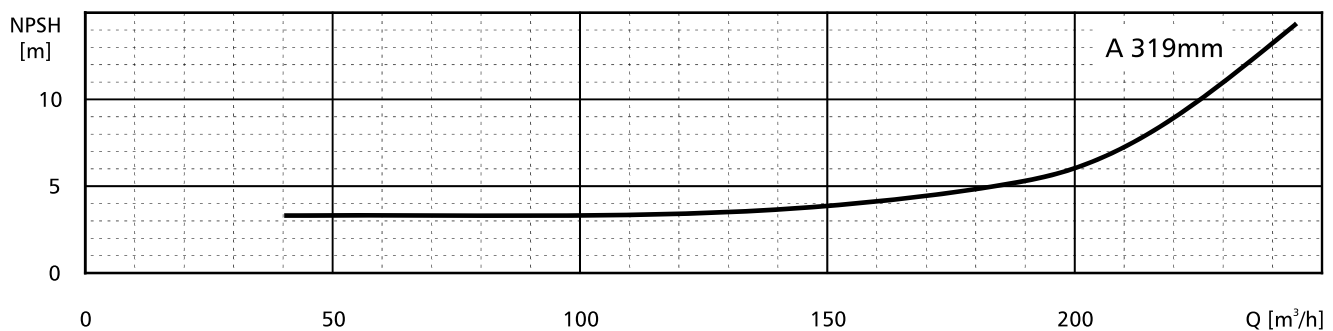
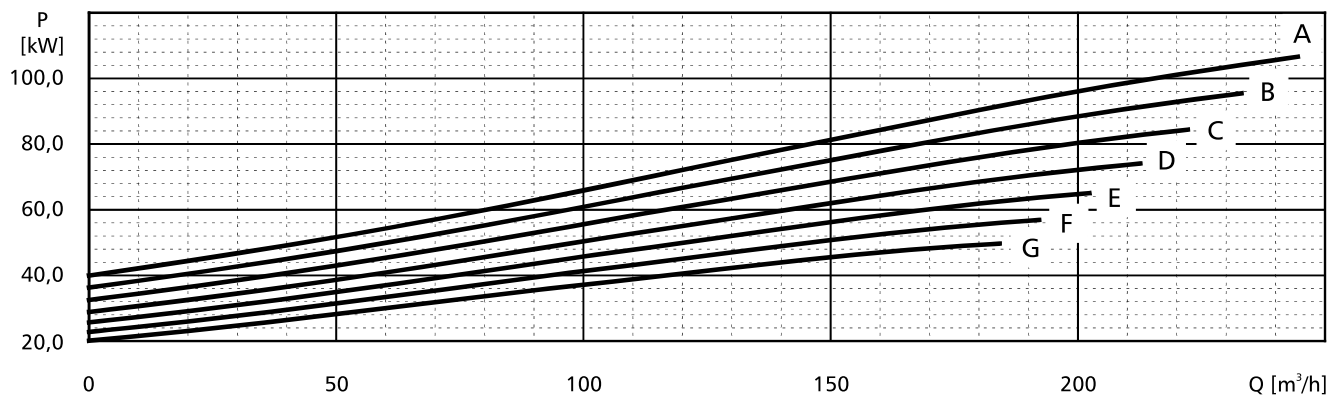
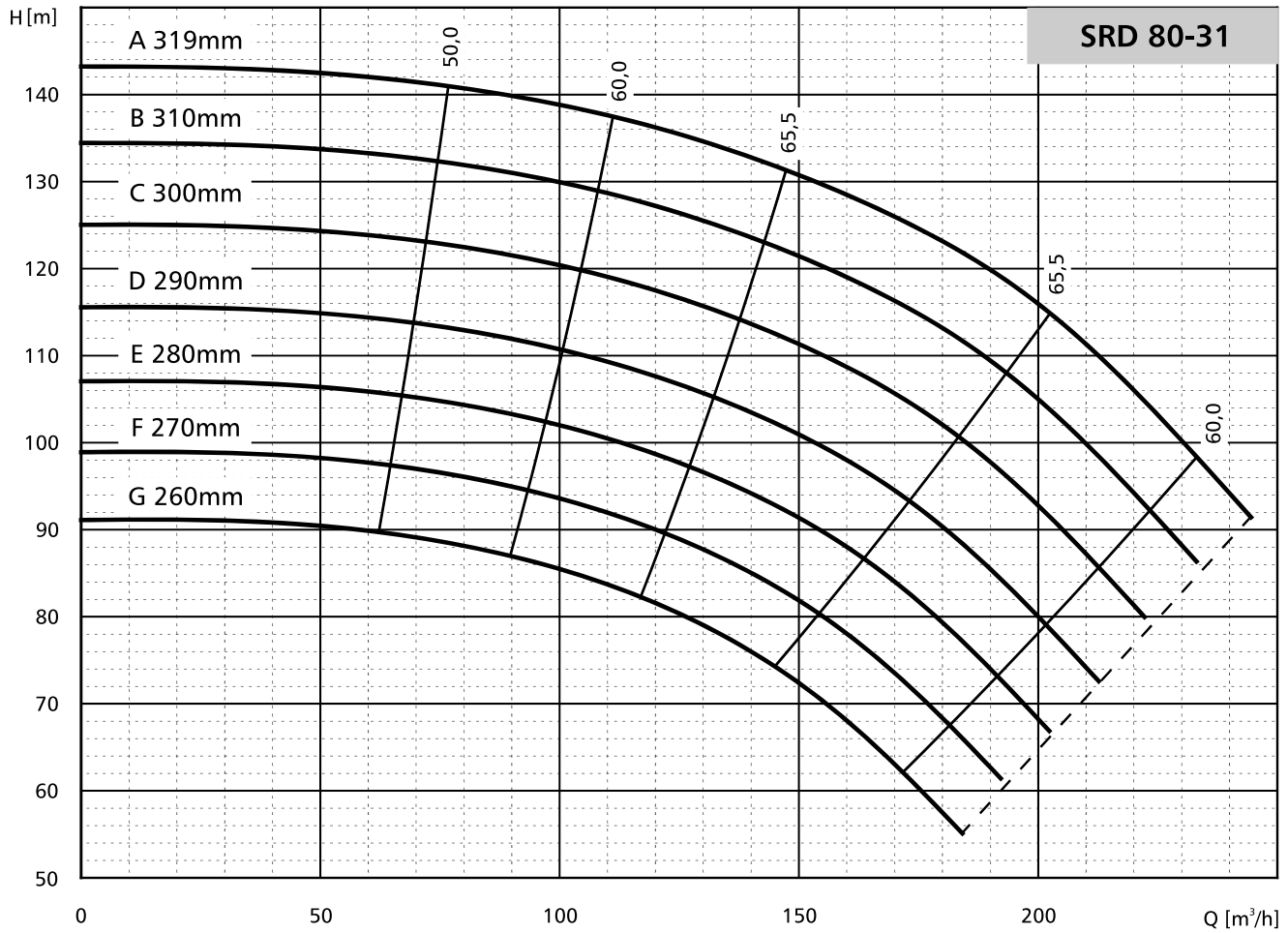

$n=2900\text{min}^{-1}$

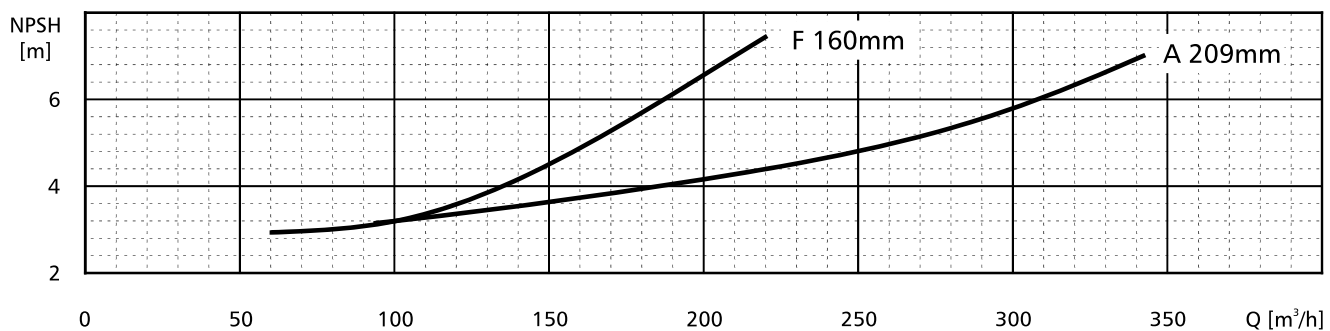
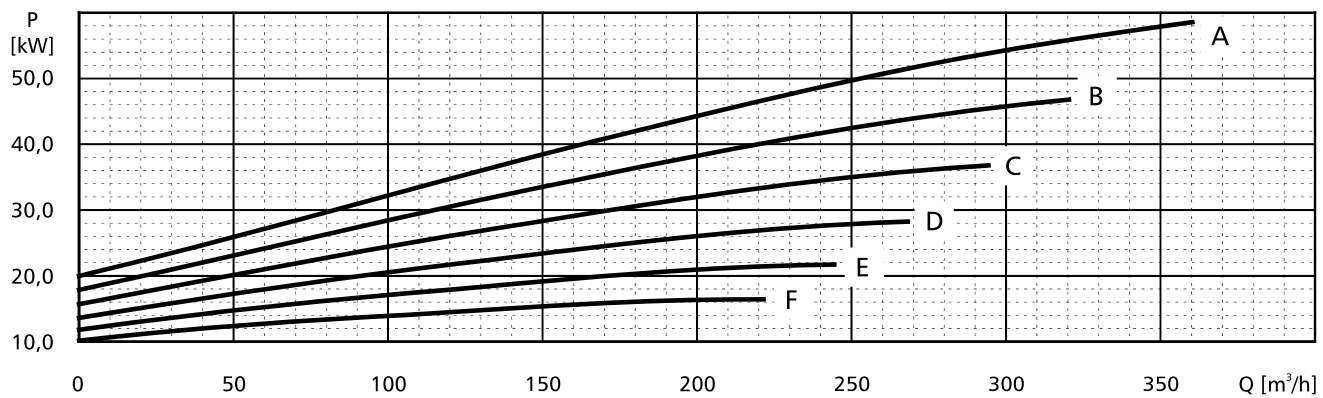
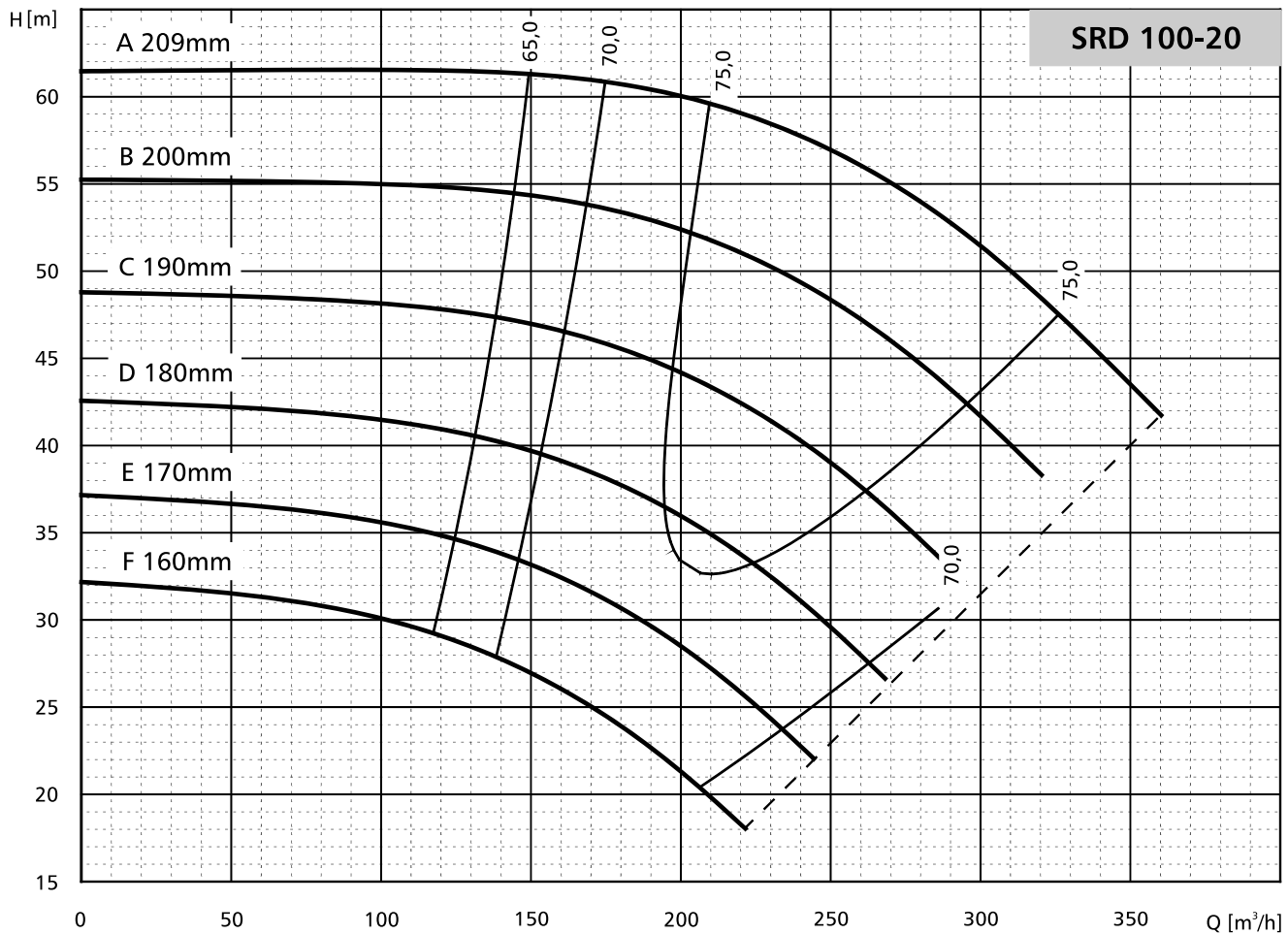

POMPY SPECJALISTYCZNE

$n=2900\text{min}^{-1}$

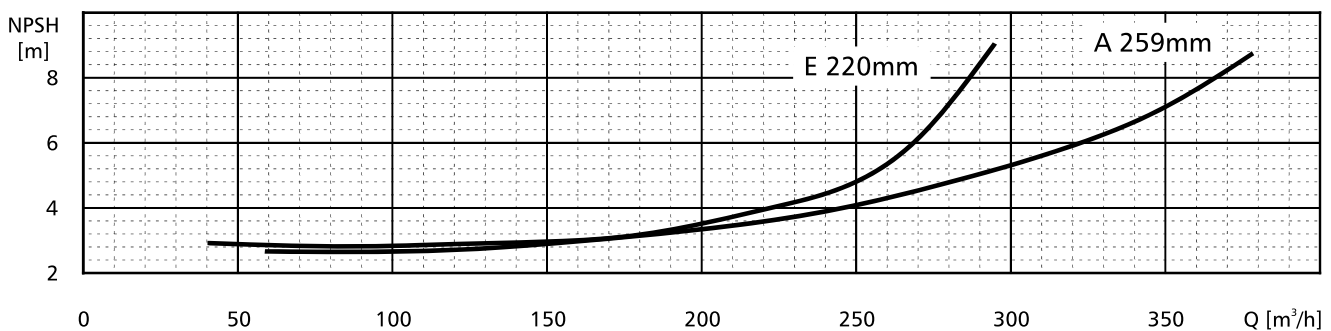
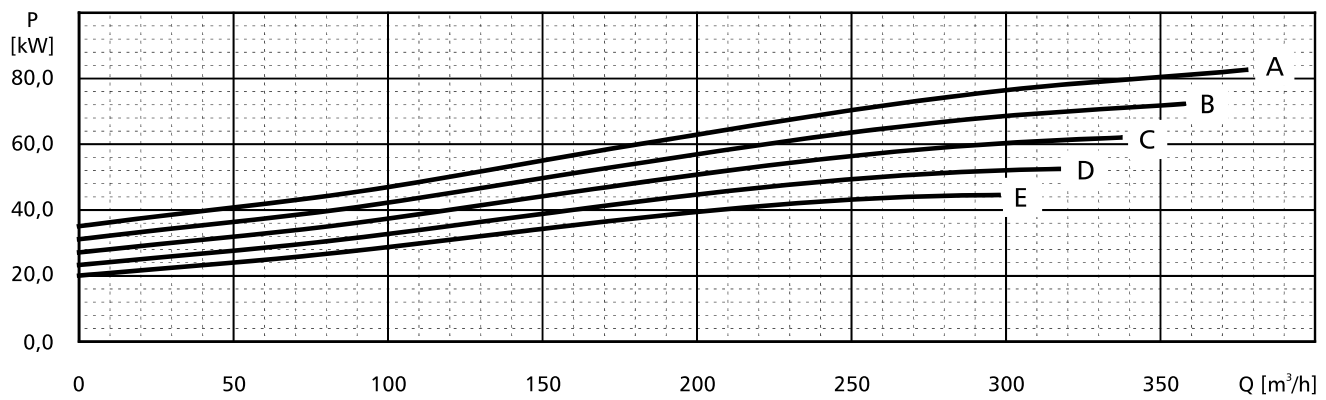
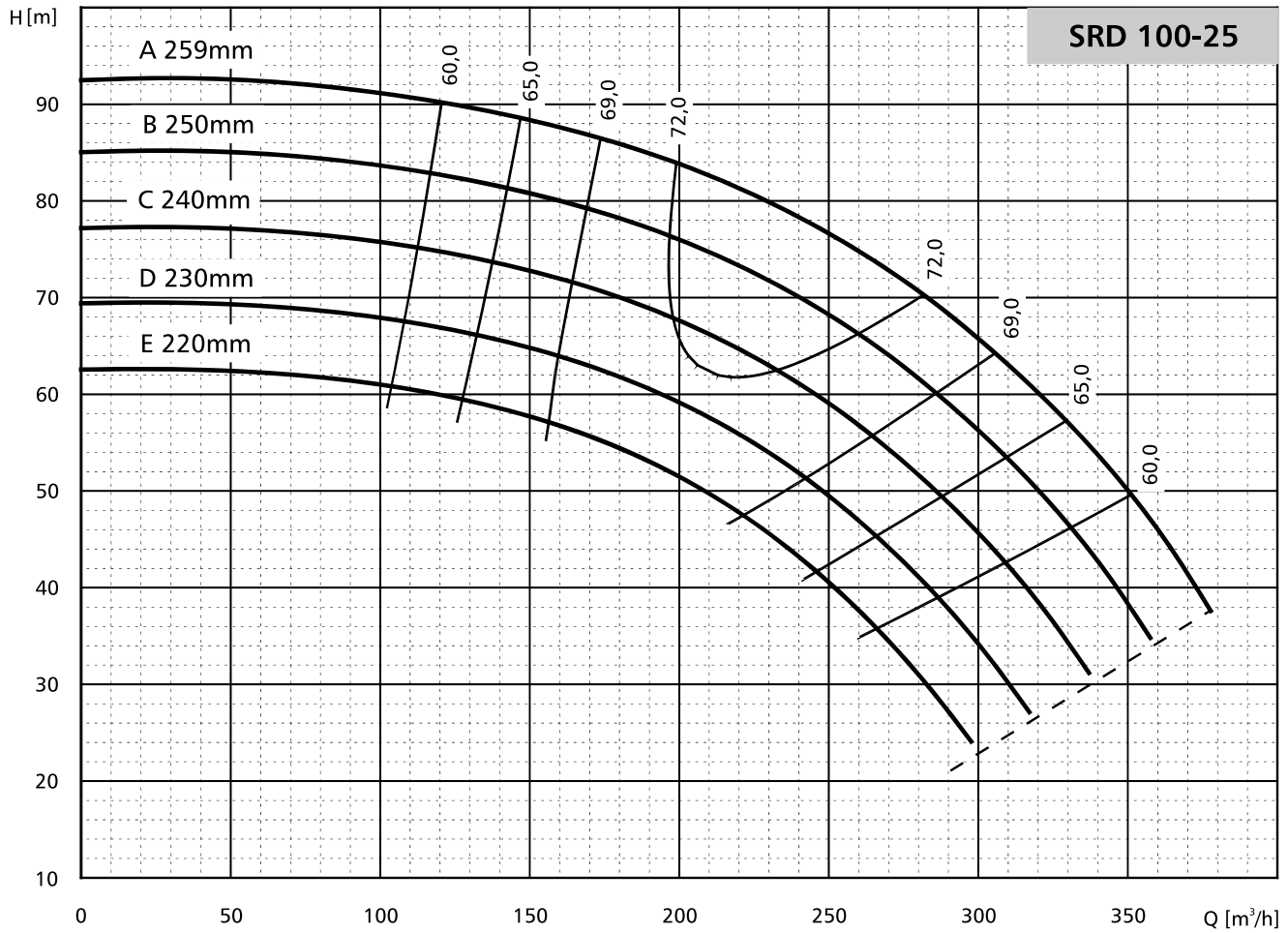

$n=2900\text{min}^{-1}$

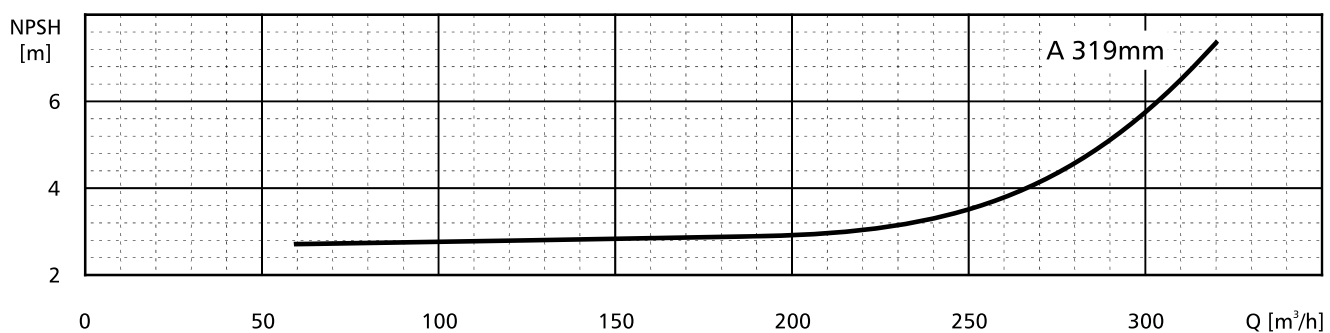
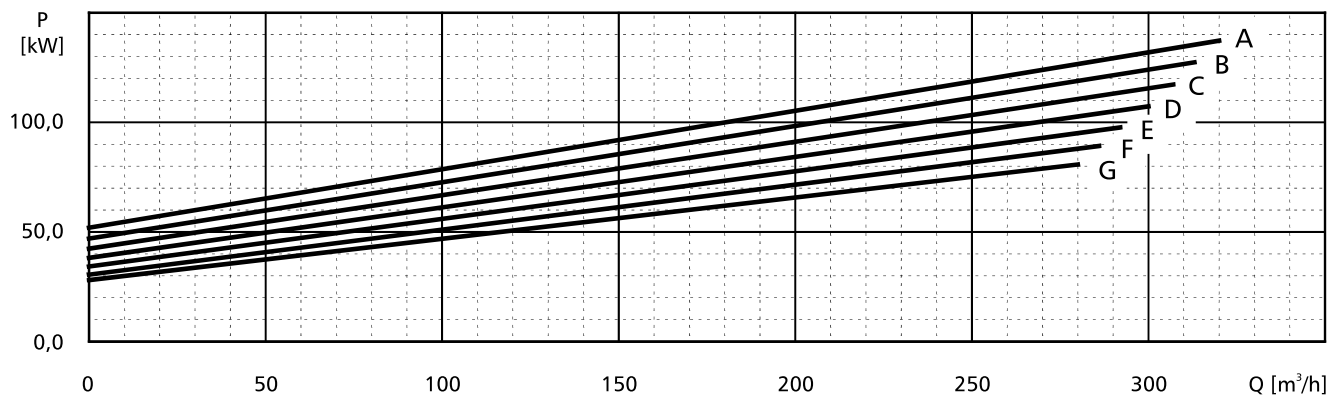
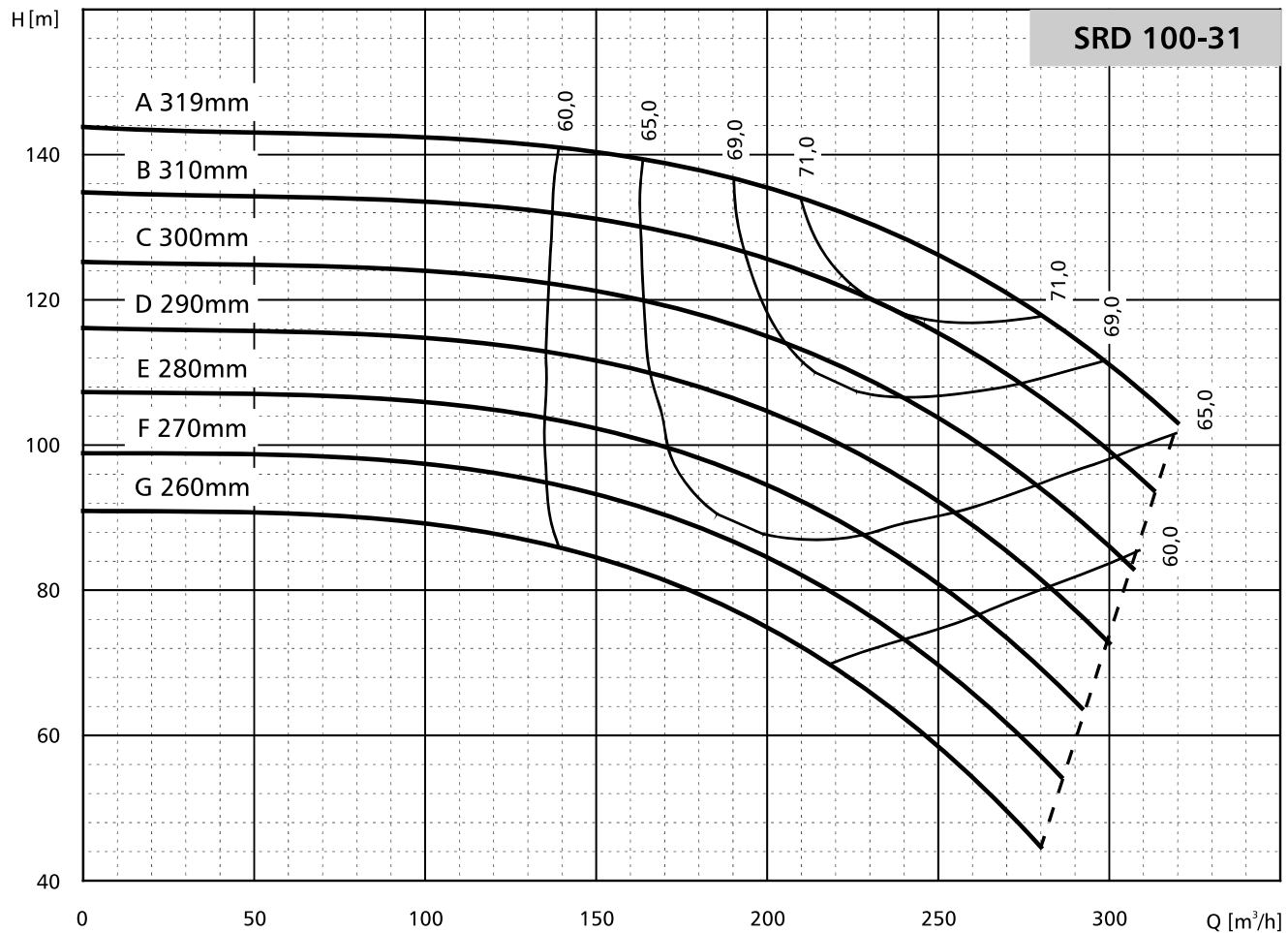

POMPY SPECJALISTYCZNE

$n=2900\text{min}^{-1}$

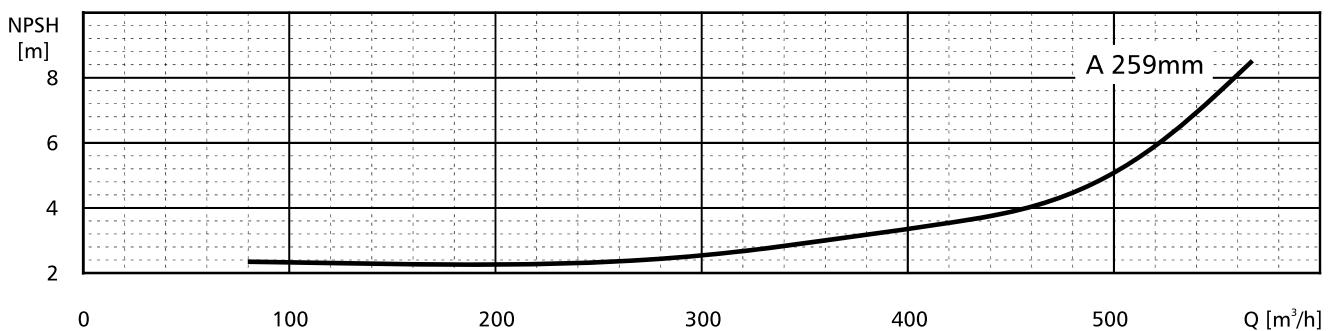
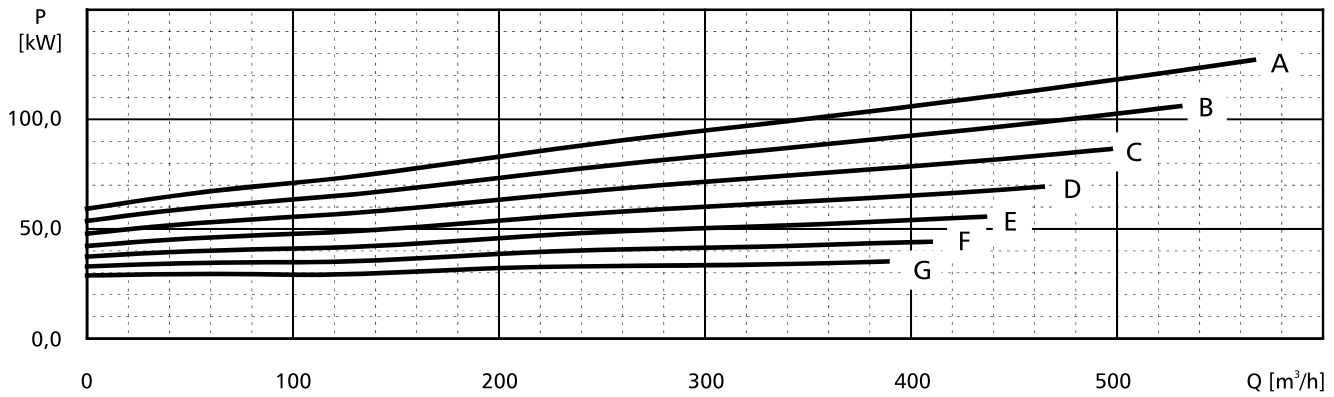
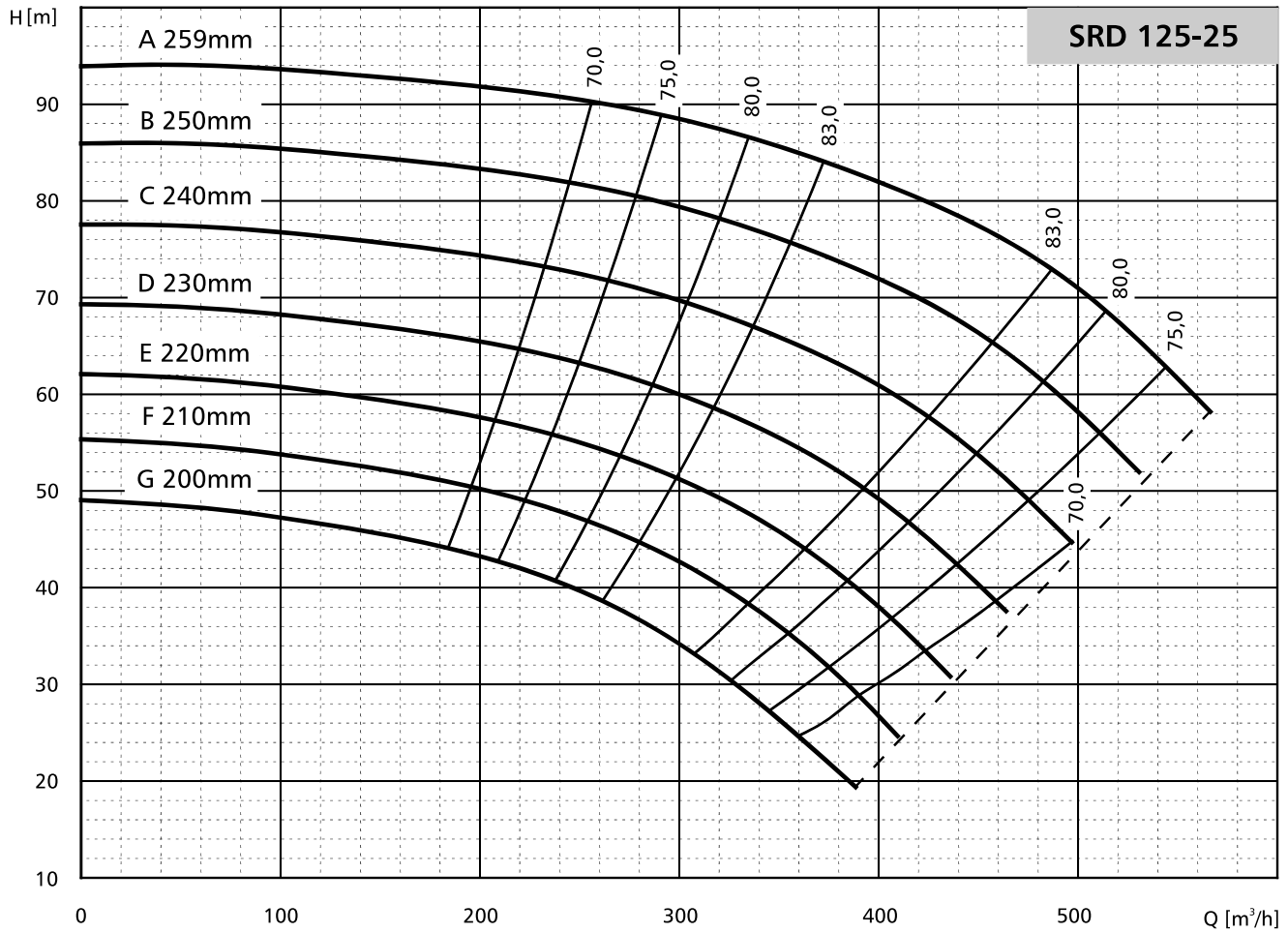

PARAMETRY TECHNICZNE

Pompy SRD A z wolnym końcem wału.

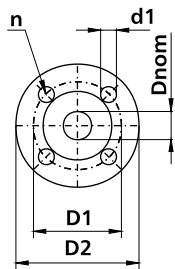
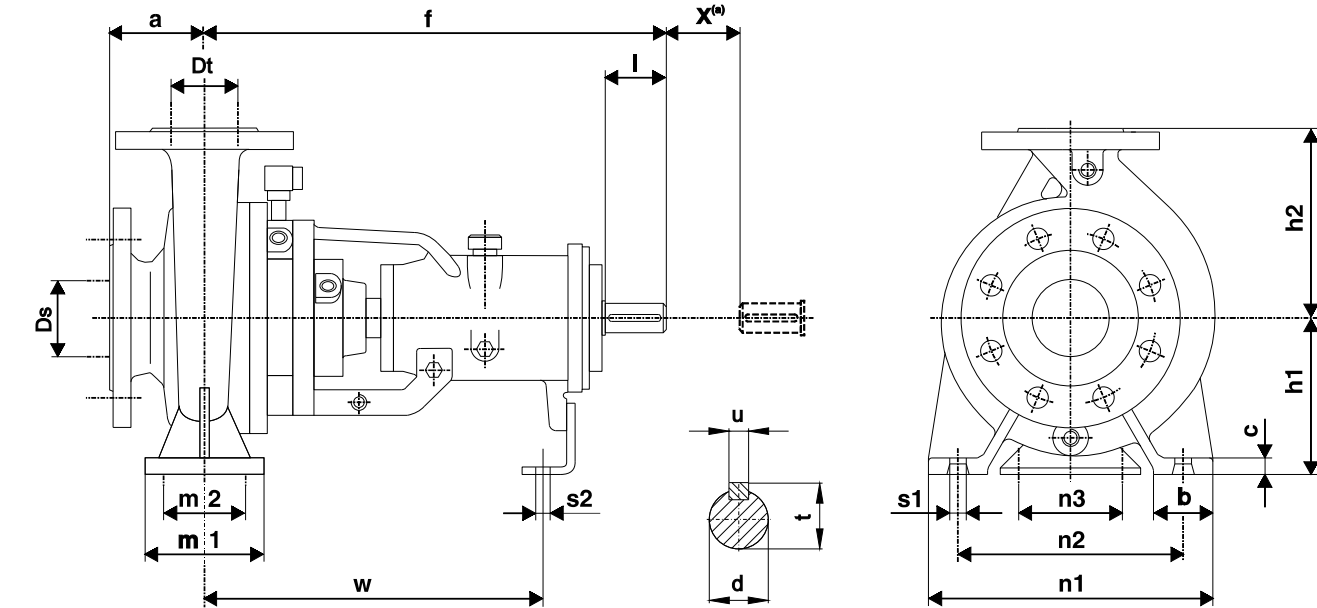

Wymiary przyłączy - PN16								
Dnom	32	40	50	65	80	100	125	150
D1	100	110	125	145	160	180	210	240
D2	140	150	165	185	200	220	250	285
d1	18	18	18	18	18	18	18	22
n	4	4	4	4	8	8	8	8

Typ pompy SRD A	Oprawa łożyskowa	Wymiary [mm]																				Masa [kg]	
		Ds	Dt	a	f	h1	h2	b	c	m1	m2	n1	n2	n3	s1	s2	w	d	l	t	u		x ^(a)
32 - 16	25	50	32	80	385	132	160	50	14	100	70	240	190	110	14	14	285	24	50	27	8	100	34
32 - 20	25	50	32	80	385	160	180	50	14	100	70	240	190	110	14	14	285	24	50	27	8	100	40
40 - 16	25	65	40	80	385	132	160	50	14	100	70	240	190	110	14	14	285	24	50	27	8	100	35
40 - 20	25	65	40	100	385	160	180	50	14	100	70	265	212	110	14	14	285	24	50	27	8	100	39
50 - 16	25	80	50	100	385	160	180	50	14	100	70	265	212	110	14	14	285	24	50	27	8	100	38
50 - 20	25	80	50	100	385	160	200	50	14	100	70	265	212	110	14	14	285	24	50	27	8	100	43
50 - 25	35	80	50	125	500	180	225	65	16	125	95	320	250	110	14	14	370	32	80	35	10	100	69
65 - 16	35	100	65	100	500	160	200	65	15	125	95	280	212	110	14	14	370	32	80	35	10	100	58
65 - 20	35	100	65	100	500	180	225	65	16	125	95	320	250	110	14	14	370	32	80	35	10	140	66
65 - 25	35	100	65	125	500	200	250	65	18	160	120	360	280	110	18	14	370	32	80	35	10	140	76
65 - 31	50	100	65	125	530	225	280	80	18	160	120	400	315	110	18	14	370	42	110	45	12	140	120
80 - 16	35	125	80	125	500	180	225	65	15	125	95	320	250	110	14	14	370	32	80	35	10	140	65
80 - 20	35	125	80	125	500	180	250	65	16	125	95	345	280	110	14	14	370	32	80	35	10	140	70
80 - 25	35	125	80	125	500	225	280	80	18	160	120	400	315	110	18	14	370	32	80	35	10	140	85
80 - 31	50	125	80	125	530	250	315	80	18	160	120	400	315	110	18	14	370	42	110	45	12	140	128
100 - 20	35	125	100	125	500	200	280	80	16	160	120	360	280	110	18	14	370	32	80	35	10	140	85
100 - 25	50	125	100	140	530	225	280	80	18	160	120	400	315	110	18	14	370	42	110	45	12	140	115
100 - 31	50	125	100	140	530	250	315	80	18	160	120	400	315	110	18	14	370	42	110	45	12	140	135
100 - 40	50	125	100	140	530	280	355	100	20	200	150	500	400	110	23	14	370	42	110	45	12	140	166
125 - 25	50	150	125	140	530	250	355	80	18	165	120	400	315	110	18	14	370	42	110	45	12	140	137
125 - 31	50	150	125	140	530	280	355	100	20	200	150	500	400	110	23	14	370	42	110	45	12	140	153
125 - 40	50	150	125	140	530	315	400	100	20	200	150	500	400	110	23	14	370	42	110	45	12	140	177

^(a) długość sprzęgła dystansowego.

POMPY SPECJALISTYCZNE

PARAMETRY TECHNICZNE

Pompy SRD K na płycie podstawy z silnikiem i sprzęgłem krótkim.

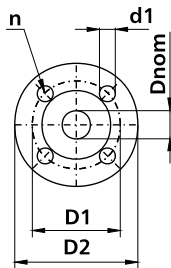
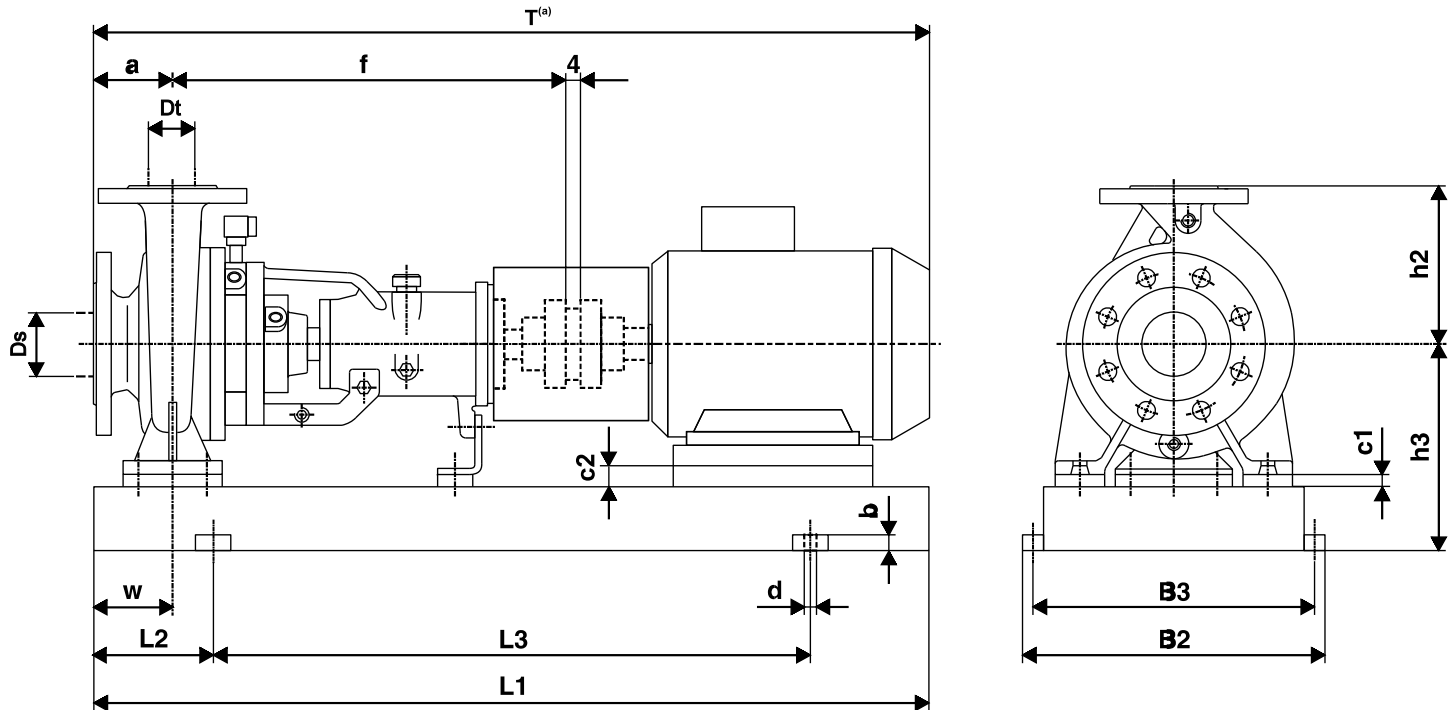

Wymiary przyłączy - PN16

Dnom	32	40	50	65	80	100	125	150
D1	100	110	125	145	160	180	210	240
D2	140	150	165	185	200	220	250	285
d1	18	18	18	18	18	18	18	22
n	4	4	4	4	8	8	8	8

Silnik (typ, wielkość, moc)

		Typ	71	80	80	90S	90L	100L	112M	132S	132M	160M	160M	160L	180M	200L	200L	225M	250M	280S	280M	315S	315M						
2-biegunowy n=2900min ⁻¹	Typ	71	80	80	90S	90L	100L	112M	132S	132M	160M	160M	160L	180M	200L	200L	225M	250M	280S	280M	315S	315M							
	Moc [kW]	0,55	0,75	1,1	1,5	2,2	3	4	5,5	7,5	9,2	11	15	18,5	22	30	37	45	55	75	90	110	132						
4-biegunowy n=1450min ⁻¹	Typ	80	80	90S	90L	100L	100L	112M	132S	132M	132M	160M	160L	180M	180L	200L	225S	225M	250M	280S	280M	315S	315M	315M	315L	355L	355L	355L	
	Moc [kW]	0,55	0,75	1,1	1,5	2,2	3	4	5,5	7,5	9,2	11	15	18,5	22	30	37	45	55	75	90	110	132	160	200	250	315	355	
2-biegunowy n=950min ⁻¹	Typ	80	90S	90L	100L	112M	132S	132M	132M	160M	160L	180L	200L	200L	225L	250M	280S	280M	315S	315M	315M	315M							
	Moc [kW]	0,55	0,75	1,1	1,5	2,2	3	4	5,5	7,5	11	15	18,5	22	30	37	45	55	75	90	110	132							

Typ pompy SRD K	Wielkość mechanicz. silnika	Typ płyty	Wymiary [mm]																Masa [kg]	
			Ds	Dt	a	f	h3	h2	L1	L2	L3	B2	B3	w	d	b	c1	c2		T ^(a)
32-16	80	1	50	32	80	385	192	160	720	120	510	350	320	60	19	30	0	52	741	63
	90S	"	"	"	"	"	"	"	"	"	"	"	"	"	"	"	"	42	764	68
	90L	"	"	"	"	"	"	"	"	"	"	"	"	"	"	"	"	"	789	72
	100L	"	"	"	"	"	"	"	"	"	"	"	"	"	"	"	"	32	827	77
	112M	"	"	"	"	"	"	"	"	"	"	"	"	"	"	"	"	20	841	86
	132S	2	"	"	"	"	252	"	1000	170	660	400	360	"	"	"	"	0	930	128
	132M	"	"	"	"	"	"	"	"	"	"	"	"	"	"	"	"	"	"	"
32-20	80	1	50	32	80	385	220	180	750	120	510	350	320	60	19	30	0	80	741	69
	90S	"	"	"	"	"	"	"	"	"	"	"	"	"	"	"	"	70	764	73
	90L	"	"	"	"	"	"	"	"	"	"	"	"	"	"	"	"	"	789	76
	100L	"	"	"	"	"	"	"	"	"	"	"	"	"	"	"	"	60	827	83
	112M	"	"	"	"	"	"	"	"	"	"	"	"	"	"	"	"	48	841	92
	132S	2	"	"	"	"	280	"	1000	170	660	400	360	"	"	"	"	28	930	134
	132M	"	"	"	"	"	"	"	"	"	"	"	"	"	"	"	"	"	"	"
160M	3	"	"	"	"	"	"	1200	205	790	440	400	"	"	"	"	0	1065	168	
40-16	80	1	65	40	80	385	192	160	750	120	510	350	320	60	19	30	0	52	741	64
	90S	"	"	"	"	"	"	"	"	"	"	"	"	"	"	"	"	42	764	68
	90L	"	"	"	"	"	"	"	"	"	"	"	"	"	"	"	"	"	789	73
	100L	"	"	"	"	"	"	"	"	"	"	"	"	"	"	"	"	32	827	79
	112M	"	"	"	"	"	"	"	"	"	"	"	"	"	"	"	"	20	841	87
	132S	2	"	"	"	"	252	"	1000	170	660	400	360	"	"	"	"	0	930	129
	132M	"	"	"	"	"	"	"	"	"	"	"	"	"	"	"	"	"	"	"
160M	3	"	"	"	"	280	"	1200	205	790	440	400	"	"	"	28	"	1065	163	
40-20	80	1	65	40	100	385	220	180	750	120	510	350	320	60	19	30	0	80	761	69
	90S	"	"	"	"	"	"	"	"	"	"	"	"	"	"	"	"	70	784	72
	90L	"	"	"	"	"	"	"	"	"	"	"	"	"	"	"	"	"	809	74
	100L	"	"	"	"	"	"	"	"	"	"	"	"	"	"	"	"	60	847	78
	112M	"	"	"	"	"	"	"	"	"	"	"	"	"	"	"	"	48	861	91
	132S	2	"	"	"	"	280	"	1000	170	660	400	360	"	"	"	"	28	950	133
	132M	"	"	"	"	"	"	"	"	"	"	"	"	"	"	"	"	"	"	"
160M	3	"	"	"	"	"	"	1200	205	790	440	400	"	"	"	"	0	1085	167	
50-16	80	1	80	50	100	385	220	180	750	120	510	350	320	60	19	30	0	80	761	70
	90S	"	"	"	"	"	"	"	"	"	"	"	"	"	"	"	"	70	784	73
	90L	"	"	"	"	"	"	"	"	"	"	"	"	"	"	"	"	"	809	76
	100L	"	"	"	"	"	"	"	"	"	"	"	"	"	"	"	"	60	847	81
	112M	"	"	"	"	"	"	"	"	"	"	"	"	"	"	"	"	48	861	91
	132S	2	"	"	"	"	280	"	1000	170	660	400	360	"	"	"	"	28	950	132
	132M	"	"	"	"	"	"	"	"	"	"	"	"	"	"	"	"	"	"	132
160M	3	"	"	"	"	"	"	1200	205	790	440	400	"	"	"	"	0	1085	166	
160L	"	"	"	"	"	"	"	"	"	"	"	"	"	"	"	"	"	"	175	
50-20	90S	1	80	50	100	385	220	200	750	120	510	350	320	60	19	30	0	70	784	78
	90L	"	"	"	"	"	"	"	"	"	"	"	"	"	"	"	"	"	809	81
	100L	"	"	"	"	"	"	"	"	"	"	"	"	"	"	"	"	60	847	86
	132S	2	"	"	"	"	280	"	1000	170	660	400	360	"	"	"	"	28	950	137
	132M	"	"	"	"	"	"	"	"	"	"	"	"	"	"	"	"	"	1085	171
	160M	3	"	"	"	"	"	"	1200	205	790	440	400	"	"	"	"	0	"	180
	160L	"	"	"	"	"	"	"	"	"	"	"	"	"	"	"	"	"	"	190
180M	"	"	"	"	"	300	"	"	"	"	"	"	"	"	"	20	"	1175	217	
180L	"	"	"	"	"	"	"	"	"	"	"	"	"	"	"	"	"	"	217	
50-25	100L	2	80	50	125	500	300	225	1000	170	660	400	360	75	19	30	0	80	987	128
	112M	"	"	"	"	"	"	"	"	"	"	"	"	"	"	"	"	68	1001	134
	132S	"	"	"	"	"	"	"	"	"	"	"	"	"	"	"	"	48	1090	139
	132M	"	"	"	"	"	"	"	"	"	"	"	"	"	"	"	"	20	"	145
	160M	3	"	"	"	"	"	"	1200	205	790	440	400	"	"	"	"	0	1225	206
	160L	"	"	"	"	"	"	"	"	"	"	"	"	"	"	"	"	"	"	216
	180M	"	"	"	"	"	"	"	"	"	"	"	"	"	"	"	"	"	1315	239
	180L	"	"	"	"	"	"	"	"	"	"	"	"	"	"	"	"	"	1330	245
	200L	5	"	"	"	"	320	"	"	"	"	505	465	"	"	"	20	"	1350	304
	225S	6	"	"	"	"	390	"	1300	215	870	510	460	"	24	13	70	25	1429	345
250M	"	"	"	"	"	415	"	"	"	"	"	"	"	"	"	95	"	1459	381	
65-16	80	2	100	65	100	500	280	200	1000	170	660	400	360	75	19	30	0	80	876	177
	90S	"	"	"	"	"	"	"	"	"	"	"	"	"	"	"	"	70	899	120
	90L	"	"	"	"	"	"	"	"	"	"	"	"	"	"	"	"	"	924	123
	100L	"	"	"	"	"	"	"	"	"	"	"	"	"	"	"	"	60	962	128
	132S	"	"	"	"	"	"	"	"	"	"	"	"	"	"	"	"	28	1065	152
	132M	"	"	"	"	"	"	"	"	"	"	"	"	"	"	"	"	"	"	152
	160M	3	"	"	"	"	"	"	1200	205	790	440	400	"	"	"	"	0	1200	198
160L	"	"	"	"	"	"	"	"	"	"	"	"	"	"	"	"	"	"	213	
65-20	90L	2	100	65	100	500	300	225	1000	170	660	400	360	75	19	30	0	90	924	137
	100L	"	"	"	"	"	"	"	"	"	"	"	"	"	"	"	"	80	964	142
	112M	"	"	"	"	"	"	"	"	"	"	"	"	"	"	"	"	68	1976	149
	132S	"	"	"	"	"	"	"	"	"	"	"	"	"	"	"	"	48	1065	159
	132M	"	"	"	"	"	"	"	"	"	"	"	"	"	"	"	"	"	"	165
	160M	3	"	"	"	"	"	"	1200	205	790	440	400	"	"	"	"	20	1200	211
	160L	"	"	"	"	"	"	"	"	"	"	"	"	"	"	"	"	"	"	211
	180M	"	"	"	"	"	"	"	"	"	"	"	"	"	"	"	"	0	1290	238
	180L	"	"	"	"	"	"	"	"	"	"	"	"	"	"	"	"	"	"	302
200L	5	"	"	"	"	"	"	"	"	"	505	465	"	"	"	20	"	1325	340	

POMPY SPECJALISTYCZNE

Typ pompy SRD K	Wielkość mechanicz. silnika	Typ płyty	Wymiary [mm]																Masa [kg]		
			Ds	Dt	a	f	h3	h2	L1	L2	L3	B2	B3	w	d	b	c1	c2		T ^(a)	
65-25	100L	3	100	65	125	500	320	250	1200	205	790	440	400	90	19	30	0	100	987	159	
	112M	"	"	"	"	"	"	"	"	"	"	"	"	"	"	"	88	1001	166		
	132S	"	"	"	"	"	"	"	"	"	"	"	"	"	"	"	68	1090	175		
	132M	"	"	"	"	"	"	"	"	"	"	"	"	"	"	"	"	"	"	185	
	160M	"	"	"	"	"	"	"	"	"	"	"	"	"	"	"	40	1225	207		
	160L	"	"	"	"	"	"	"	"	"	"	"	"	"	"	"	"	"	"	1240	217
	180M	"	"	"	"	"	"	"	"	"	"	"	"	"	"	"	20	1315	248		
	180L	"	"	"	"	"	"	"	"	"	"	"	"	"	"	"	"	"	"	"	260
	200L	5	"	"	"	"	"	"	"	1200	205	790	505	465	"	"	"	0	1350	312	
	225S	6	"	"	"	"	390	"	"	1300	215	870	510	460	"	24	13	50	25	1429	354
	225M	"	"	"	"	"	"	"	"	"	"	"	"	"	"	"	"	"	"	"	378
250M	"	"	"	"	"	415	"	"	"	"	"	"	"	"	"	"	75	"	1510	420	
280S	7	"	"	"	"	445	"	"	1450	235	980	560	510	"	"	"	105	"	1589	620	
65-31	132S	5	100	65	125	530	345	280	1200	205	790	505	465	90	19	30	0	93	1120	225	
	132M	"	"	"	"	"	"	"	"	"	"	"	"	"	"	"	"	"	"	235	
	160M	"	"	"	"	"	"	"	"	"	"	"	"	"	"	"	"	65	1255	257	
	160L	"	"	"	"	"	"	"	"	"	"	"	"	"	"	"	"	"	"	272	
	180M	"	"	"	"	"	"	"	"	"	"	"	"	"	"	"	"	45	1345	315	
	180L	"	"	"	"	"	"	"	"	"	"	"	"	"	"	"	"	"	"	322	
	200L	"	"	"	"	"	"	"	"	"	"	"	"	"	"	"	25	1430	391		
	225S	6	"	"	"	"	390	"	"	1300	215	870	510	460	"	24	13	25	"	1490	442
	225M	"	"	"	"	"	"	"	"	"	"	"	"	"	"	"	"	"	"	"	452
	250M	7	"	"	"	"	415	"	"	1450	235	980	560	510	"	"	"	50	"	1530	490
	280S	"	"	"	"	"	445	"	"	"	"	"	"	"	"	"	"	58	"	1715	660
280M	"	"	"	"	"	"	"	"	"	"	"	"	"	"	"	"	"	"	"	725	
80-16	90S	2	125	80	125	500	300	225	1000	170	660	400	360	75	19	30	0	90	924	138	
	90L	"	"	"	"	"	"	"	"	"	"	"	"	"	"	"	"	"	929	141	
	100L	"	"	"	"	"	"	"	"	"	"	"	"	"	"	"	"	80	987	146	
	112M	"	"	"	"	"	"	"	"	"	"	"	"	"	"	"	"	68	1001	149	
	132S	"	"	"	"	"	"	"	"	"	"	"	"	"	"	"	"	48	1090	167	
	132M	"	"	"	"	"	"	"	"	"	"	"	"	"	"	"	"	"	"	175	
	160M	3	"	"	"	"	"	"	1200	205	790	440	400	"	"	"	20	1225	220		
	160L	"	"	"	"	"	"	"	"	"	"	"	"	"	"	"	"	"	"	230	
	180M	"	"	"	"	"	"	"	"	"	"	"	"	"	"	"	"	0	1315	247	
	180L	"	"	"	"	"	"	"	"	"	"	"	"	"	"	"	"	"	"	257	
	200L	5	"	"	"	"	320	"	"	"	"	"	505	465	"	"	20	"	1350	327	
80-20	100L	3	125	80	125	500	300	250	1200	205	790	440	400	75	19	30	0	80	987	154	
	112M	"	"	"	"	"	"	"	"	"	"	"	"	"	"	"	"	68	1001	161	
	132S	"	"	"	"	"	"	"	"	"	"	"	"	"	"	"	"	48	1090	172	
	132M	"	"	"	"	"	"	"	"	"	"	"	"	"	"	"	"	"	"	182	
	160M	"	"	"	"	"	"	"	"	"	"	"	"	"	"	"	"	20	1225	204	
	160L	"	"	"	"	"	"	"	"	"	"	"	"	"	"	"	"	"	"	225	
	180M	"	"	"	"	"	"	"	"	"	"	"	"	"	"	"	"	0	1315	252	
	180L	"	"	"	"	"	"	"	"	"	"	"	"	"	"	"	"	"	"	262	
	200L	5	"	"	"	"	320	"	"	"	"	"	505	465	"	"	20	"	1350	348	
	225S	6	"	"	"	"	390	"	"	1300	215	870	510	460	"	24	13	70	25	1429	392
	225M	"	"	"	"	"	"	"	"	"	"	"	"	"	"	"	"	"	"	"	402
250M	"	"	"	"	"	415	"	"	"	"	"	"	"	"	"	"	95	"	1459	427	
80-25	112M	5	125	80	125	500	345	280	1200	205	790	505	465	90	19	30	0	113	1001	177	
	132S	"	"	"	"	"	"	"	"	"	"	"	"	"	"	"	"	93	1090	188	
	132M	"	"	"	"	"	"	"	"	"	"	"	"	"	"	"	"	"	"	198	
	160M	"	"	"	"	"	"	"	"	"	"	"	"	"	"	"	"	65	1225	250	
	160L	"	"	"	"	"	"	"	"	"	"	"	"	"	"	"	"	"	"	280	
	200L	"	"	"	"	"	"	"	"	"	"	"	"	"	"	"	"	25	1350	330	
	225S	6	"	"	"	"	390	"	"	1300	215	870	510	460	"	24	13	25	"	1429	402
	225M	"	"	"	"	"	"	"	"	"	"	"	"	"	"	"	"	"	"	1439	420
	250M	"	"	"	"	"	415	"	"	"	"	"	"	"	"	"	"	50	"	1459	437
	280S	7	"	"	"	"	445	"	"	1450	235	980	560	510	"	"	"	80	"	1589	505
	80-31	132M	5	125	80	125	530	370	315	1200	205	790	505	465	90	19	30	0	118	1120	240
160M		"	"	"	"	"	"	"	"	"	"	"	"	"	"	"	"	25	90	1255	262
160L		"	"	"	"	"	"	"	"	"	"	"	"	"	"	"	"	"	"	277	
180M		"	"	"	"	"	"	"	"	"	"	"	"	"	"	"	"	70	1335	320	
180L		"	"	"	"	"	"	"	"	"	"	"	"	"	"	"	"	"	"	345	
250M		7	"	"	"	"	415	"	"	1450	235	980	560	510	"	24	13	55	25	1489	490
280S		"	"	"	"	"	445	"	"	"	"	"	"	"	"	"	"	"	"	1715	670
280M		"	"	"	"	"	"	"	"	"	"	"	"	"	"	"	"	"	"	"	735
100-20	100L	3	125	100	125	500	320	280	1200	205	790	440	400	90	19	30	0	100	987	170	
	112M	"	"	"	"	"	"	"	"	"	"	"	"	"	"	"	"	88	1001	177	
	132S	"	"	"	"	"	"	"	"	"	"	"	"	"	"	"	"	68	1090	188	
	132M	"	"	"	"	"	"	"	"	"	"	"	"	"	"	"	"	"	"	198	
	160M	"	"	"	"	"	"	"	"	"	"	"	"	"	"	"	"	40	1225	220	
	160L	"	"	"	"	"	"	"	"	"	"	"	"	"	"	"	"	"	"	240	
	180M	"	"	"	"	"	"	"	"	"	"	"	"	"	"	"	"	20	1315	270	
	200L	5	"	"	"	"	"	"	1200	205	790	505	465	"	"	"	"	0	1350	347	
	225M	6	"	"	"	"	390	"	"	1300	215	870	510	460	"	24	13	50	25	1429	413
	250M	"	"	"	"	"	415	"	"	"	"	"	"	"	"	"	"	75	"	1500	445
	280S	7	"	"	"	"	445	"	"	1450	235	980	560	510	"	"	"	105	"	1685	625

Typ pompy SRD K	Wielkość mechanicz. silnika	Typ płyty	Wymiary [mm]																Masa [kg]		
			Ds	Dt	a	f	h3	h2	L1	L2	L3	B2	B3	w	d	b	c1	c2		T ⁽⁹⁾	
100-25	132S	5	125	100	125	530	345	280	1200	205	790	505	465	90	19	30	0	93	1135	217	
	132M	"	"	"	"	"	"	"	"	"	"	"	"	"	"	"	"	"	"	227	
	160M	"	"	"	"	"	"	"	"	"	"	"	"	"	"	"	65	1270	249		
	160L	"	"	"	"	"	"	"	"	"	"	"	"	"	"	"	"	"	"	264	
	180M	"	"	"	"	"	"	"	"	"	"	"	"	"	"	"	"	45	1360	309	
	180L	"	"	"	"	"	"	"	"	"	"	"	"	"	"	"	"	"	"	"	330
	200L	6	"	"	"	"	390	"	1300	215	870	510	460	"	24	13	25	50	1440	385	
	225M	"	"	"	"	"	"	"	"	"	"	"	"	"	"	"	"	25	1500	436	
	250M	7	"	"	"	"	415	"	1450	235	980	560	510	"	"	"	"	50	1545	475	
	280S	"	"	"	"	"	445	"	"	"	"	"	"	"	"	"	"	80	1730	655	
280M	"	"	"	"	"	"	"	"	"	"	"	"	"	"	"	"	"	"	"	720	
100-31	160M	5	125	100	140	530	370	315	1200	205	790	505	465	90	19	30	0	90	1370	269	
	160L	"	"	"	"	"	"	"	"	"	"	"	"	"	"	"	"	"	"	284	
	180M	"	"	"	"	"	"	"	"	"	"	"	"	"	"	"	"	70	1360	329	
	180L	"	"	"	"	"	"	"	"	"	"	"	"	"	"	"	"	"	"	344	
	200L	6	"	"	"	"	415	"	1300	215	870	510	460	"	24	13	25	75	1395	395	
	250M	7	"	"	"	"	"	"	1450	235	980	560	510	"	"	"	"	25	1560	495	
	280S	"	"	"	"	"	445	"	"	"	"	"	"	"	"	"	"	55	1745	675	
	280M	"	"	"	"	"	"	"	"	"	"	"	"	"	"	"	"	"	"	"	740
	315S	10	"	"	"	"	520	"	2000	260	1480	710	660	"	"	"	90	"	1840	950	
	315M	"	"	"	"	"	"	"	"	"	"	"	"	"	"	"	"	"	"	"	980
100-40	132M	6	125	100	140	530	445	355	1300	215	870	510	460	110	24	13	25	173	1150	280	
	160M	"	"	"	"	"	"	"	"	"	"	"	"	"	"	"	"	145	1270	305	
	160L	"	"	"	"	"	"	"	"	"	"	"	"	"	"	"	"	"	"	319	
	180M	"	"	"	"	"	"	"	"	"	"	"	"	"	"	"	"	125	1360	364	
	180L	"	"	"	"	"	"	"	"	"	"	"	"	"	"	"	"	"	"	379	
	200L	"	"	"	"	"	"	"	"	"	"	"	"	"	"	"	"	105	1395	426	
	225S	"	"	"	"	"	"	"	"	"	"	"	"	"	"	"	"	80	1504	478	
225M	"	"	"	"	"	"	"	"	"	"	"	"	"	"	"	"	"	"	"	513	
125-25	132M	5	150	125	140	530	370	355	1200	205	790	505	465	90	19	30	0	118	1135	249	
	160M	"	"	"	"	"	"	"	"	"	"	"	"	"	"	"	"	90	1320	271	
	160L	"	"	"	"	"	"	"	"	"	"	"	"	"	"	"	"	"	"	286	
	180M	"	"	"	"	"	"	"	"	"	"	"	"	"	"	"	"	70	1410	331	
	180L	"	"	"	"	"	"	"	"	"	"	"	"	"	"	"	"	"	"	346	
	200L	"	"	"	"	"	"	"	"	"	"	"	"	"	"	"	"	50	1445	355	
	225M	6	"	"	"	"	415	"	1300	215	870	510	460	"	24	13	25	"	1554	425	
	250M	7	"	"	"	"	"	"	1450	235	980	560	510	"	"	"	"	25	1610	500	
	280S	"	"	"	"	"	445	"	"	"	"	"	"	"	"	"	"	55	1795	680	
	280M	"	"	"	"	"	"	"	"	"	"	"	"	"	"	"	"	"	"	"	745
315S	10	"	"	"	"	520	"	2000	260	1480	710	660	"	"	"	90	"	1890	955		
315M	"	"	"	"	"	"	"	"	"	"	"	"	"	"	"	"	"	"	"	985	
125-31	132S	6	150	125	140	530	445	355	1300	215	870	510	460	110	24	13	25	173	1135	277	
	132M	"	"	"	"	"	"	"	"	"	"	"	"	"	"	"	"	"	"	287	
	160M	"	"	"	"	"	"	"	"	"	"	"	"	"	"	"	"	145	1320	310	
	160L	"	"	"	"	"	"	"	"	"	"	"	"	"	"	"	"	"	"	355	
	180M	"	"	"	"	"	"	"	"	"	"	"	"	"	"	"	"	125	1410	370	
	180L	"	"	"	"	"	"	"	"	"	"	"	"	"	"	"	"	"	"	417	
	200L	"	"	"	"	"	"	"	"	"	"	"	"	"	"	"	"	105	1445	469	
225S	"	"	"	"	"	"	"	"	"	"	"	"	"	"	"	"	80	1504	518		
125-40	132M	6	150	125	140	530	480	400	1300	215	870	510	460	110	24	13	25	208	1135	310	
	160M	"	"	"	"	"	"	"	"	"	"	"	"	"	"	"	"	180	1320	335	
	160L	"	"	"	"	"	"	"	"	"	"	"	"	"	"	"	"	"	"	370	
	180M	"	"	"	"	"	"	"	"	"	"	"	"	"	"	"	"	160	1410	380	
	180L	"	"	"	"	"	"	"	"	"	"	"	"	"	"	"	"	"	"	393	
	200L	"	"	"	"	"	"	"	"	"	"	"	"	"	"	"	"	140	1485	440	
	225S	"	"	"	"	"	"	"	"	"	"	"	"	"	"	"	"	115	1504	492	
	225M	"	"	"	"	"	"	"	"	"	"	"	"	"	"	"	"	"	"	527	
	250M	7	"	"	"	"	"	"	1450	235	980	560	510	"	"	"	"	90	1610	564	
	280S	"	"	"	"	"	"	"	"	"	"	"	"	"	"	"	"	60	1795	620	
280M	"	"	"	"	"	"	"	"	"	"	"	"	"	"	"	"	"	"	"	680	

POMPY SPECJALISTYCZNE

PARAMETRY TECHNICZNE

Pompy SRD D na płycie podstawy z silnikiem i sprzęgłem demontowalnym.

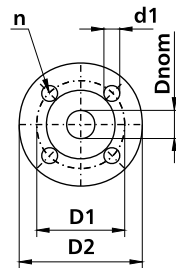
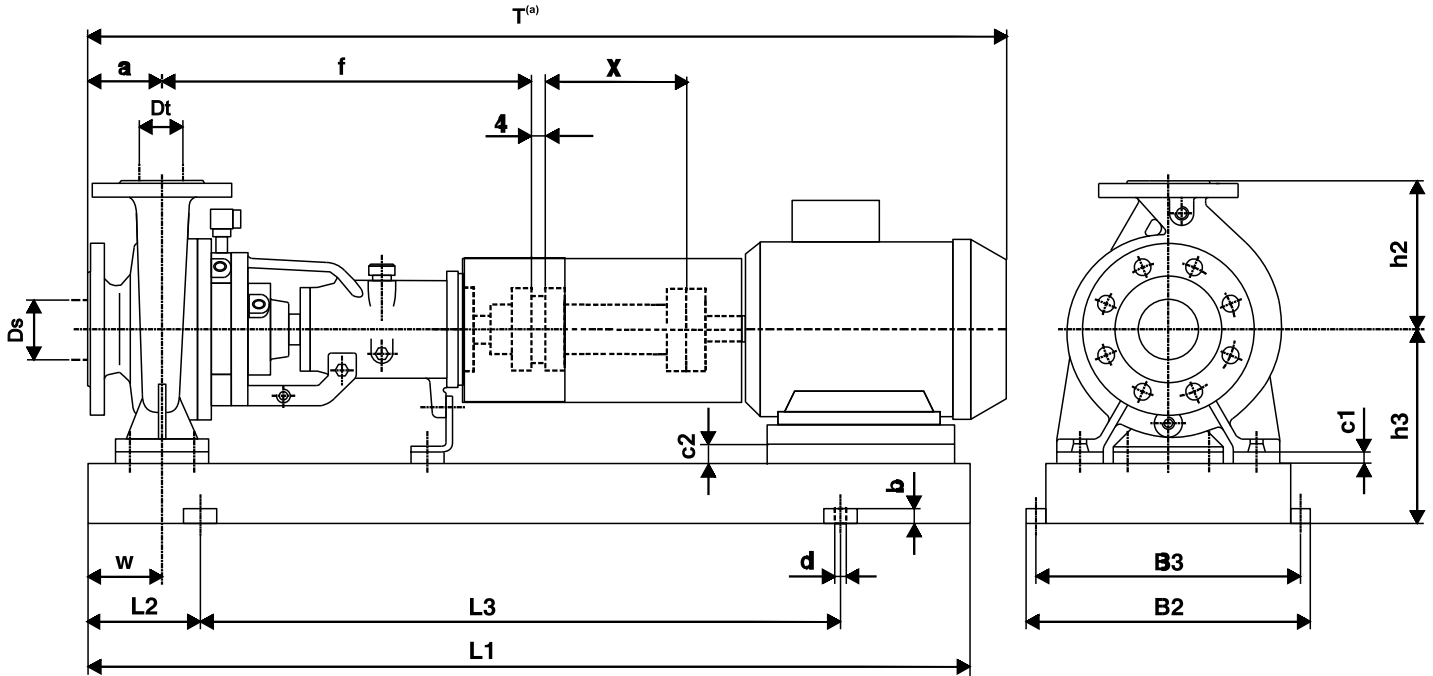

Wymiary przyłączy - PN16								
Dnom	32	40	50	65	80	100	125	150
D1	100	110	125	145	160	180	210	240
D2	140	150	165	185	200	220	250	285
d1	18	18	18	18	18	18	18	22
n	4	4	4	4	8	8	8	8

Długość łącznika płytkowego sprzęgła (demontowalnego)														
Typ pompy SRDD		32-16	32-20	40-16	40-20	50-16	50-20	50-25	65-16	65-20	65-25	65-31	80-16	80-20
Obudowa łożyska	[mm]	25	25	25	25	25	25	35	35	35	35	50	35	35
Wymiar "X"	[mm]	100	100	100	100	100	100	100	100	140	140	140	140	140

Silnik (typ, wielkość, moc)																												
2-biegunowy $n=2900\text{min}^{-1}$	Typ	71	80	80	90S	90L	100L	112M	132S	132S	132M	160M	160M	160L	180M	200L	200L	225M	250M	280S	280M	315S	315M					
	Moc [kW]	0,55	0,75	1,1	1,5	2,2	3	4	5,5	7,5	9,2	11	15	18,5	22	30	37	45	55	75	90	110	132					
4-biegunowy $n=1450\text{min}^{-1}$	Typ	80	80	90S	90L	100L	100L	112M	132S	132M	132M	160M	160L	180M	180L	200L	225S	225M	250M	280S	280M	315S	315M	315M	315L	355L	355L	355L
	Moc [kW]	0,55	0,75	1,1	1,5	2,2	3	4	5,5	7,5	9,2	11	15	18,5	22	30	37	45	55	75	90	110	132	160	200	250	315	355
2-biegunowy $n=950\text{min}^{-1}$	Typ	80	90S	90L	100L	112M	132S	132M	132M	160M	160L	180L	200L	200L	225L	250M	280S	280M	315S	315M	315M	315M						
	Moc [kW]	0,55	0,75	1,1	1,5	2,2	3	4	5,5	7,5	11	15	18,5	22	30	37	45	55	75	90	110	132						

Typ pompy SRD D	Wielkość mechanicz. silnika	Typ płyty	Wymiary [mm]																	Masa [kg]	
			Ds	Dt	a	f	h3	h2	L1	L2	L3	B2	B3	w	d	b	c1	c2	T ⁽⁶⁾		
32-16	80	2	50	32	80	385	252	160	1000	170	660	400	360	60	19	30	0	52	841	63	
	90S	"	"	"	"	"	"	"	"	"	"	"	"	"	"	"	"	42	864	68	
	90L	"	"	"	"	"	"	"	"	"	"	"	"	"	"	"	"	"	889	72	
	100L	"	"	"	"	"	"	"	"	"	"	"	"	"	"	"	"	"	32	927	77
	112M	"	"	"	"	"	"	"	"	"	"	"	"	"	"	"	"	"	20	941	86
	132S	"	"	"	"	"	"	"	"	"	"	"	"	"	"	"	"	"	0	1030	128
	132M	"	"	"	"	"	"	"	"	"	"	"	"	"	"	"	"	"	"	"	"
32-20	80	2	50	32	80	385	280	180	1000	170	660	400	360	60	19	30	0	80	841	69	
	90S	"	"	"	"	"	"	"	"	"	"	"	"	"	"	"	"	70	864	73	
	90L	"	"	"	"	"	"	"	"	"	"	"	"	"	"	"	"	"	889	76	
	100L	"	"	"	"	"	"	"	"	"	"	"	"	"	"	"	"	"	60	927	83
	112M	"	"	"	"	"	"	"	"	"	"	"	"	"	"	"	"	"	48	941	92
	132S	"	"	"	"	"	"	"	"	"	"	"	"	"	"	"	"	"	28	1030	134
	132M	"	"	"	"	"	"	"	"	"	"	"	"	"	"	"	"	"	"	"	"
160M	3	"	"	"	"	"	"	"	1200	205	790	440	400	60	19	30	"	0	1165	168	
40-16	80	2	65	40	80	385	252	160	1000	170	660	400	360	60	19	30	0	52	841	64	
	90S	"	"	"	"	"	"	"	"	"	"	"	"	"	"	"	"	42	864	68	
	90L	"	"	"	"	"	"	"	"	"	"	"	"	"	"	"	"	"	32	889	73
	100L	"	"	"	"	"	"	"	"	"	"	"	"	"	"	"	"	"	20	927	79
	112M	"	"	"	"	"	"	"	"	"	"	"	"	"	"	"	"	"	0	941	87
	132S	"	"	"	"	"	"	"	"	"	"	"	"	"	"	"	"	"	"	1030	129
	132M	"	"	"	"	"	"	"	"	"	"	"	"	"	"	"	"	"	"	"	"
160M	3	"	"	"	"	280	"	1200	205	790	440	400	60	19	30	28	"	1165	163		
40-20	80	2	65	40	100	385	280	180	1000	170	660	400	360	60	19	30	0	80	861	69	
	90S	"	"	"	"	"	"	"	"	"	"	"	"	"	"	"	"	70	884	72	
	90L	"	"	"	"	"	"	"	"	"	"	"	"	"	"	"	"	"	909	74	
	100L	"	"	"	"	"	"	"	"	"	"	"	"	"	"	"	"	"	60	947	78
	112M	"	"	"	"	"	"	"	"	"	"	"	"	"	"	"	"	"	48	961	91
	132S	"	"	"	"	"	"	"	"	"	"	"	"	"	"	"	"	"	28	1050	133
	132M	"	"	"	"	"	"	"	"	"	"	"	"	"	"	"	"	"	"	"	"
160M	3	"	"	"	"	"	"	1200	205	790	440	400	"	"	"	"	"	0	1185	167	
50-16	80	2	80	50	100	385	280	180	1000	170	660	400	360	60	19	30	0	80	861	70	
	90S	"	"	"	"	"	"	"	"	"	"	"	"	"	"	"	"	70	884	73	
	90L	"	"	"	"	"	"	"	"	"	"	"	"	"	"	"	"	"	909	76	
	100L	"	"	"	"	"	"	"	"	"	"	"	"	"	"	"	"	"	60	947	81
	112M	"	"	"	"	"	"	"	"	"	"	"	"	"	"	"	"	"	48	961	91
	132S	"	"	"	"	"	"	"	"	"	"	"	"	"	"	"	"	"	28	1050	132
	132M	"	"	"	"	"	"	"	"	"	"	"	"	"	"	"	"	"	"	"	132
160M	3	"	"	"	"	"	"	1200	205	790	440	400	"	"	"	"	"	0	1185	166	
160L	"	"	"	"	"	"	"	"	"	"	"	"	"	"	"	"	"	"	"	175	
50-20	90S	2	80	50	100	385	280	200	1000	170	660	400	360	60	19	30	0	70	884	78	
	90L	"	"	"	"	"	"	"	"	"	"	"	"	"	"	"	"	"	909	81	
	100L	"	"	"	"	"	"	"	"	"	"	"	"	"	"	"	"	"	60	947	86
	132S	"	"	"	"	"	"	"	"	"	"	"	"	"	"	"	"	"	28	1050	137
	132M	"	"	"	"	"	"	"	"	"	"	"	"	"	"	"	"	"	0	1185	171
	160M	3	"	"	"	"	"	"	1200	205	790	440	400	"	"	"	"	"	"	"	180
	160L	"	"	"	"	"	"	"	"	"	"	"	"	"	"	"	"	"	"	"	190
180M	"	"	"	"	"	"	"	"	"	"	"	"	"	"	"	20	"	1275	217		
180L	"	"	"	"	"	"	"	"	"	"	"	"	"	"	"	"	"	"	"	217	
50-25	100L	2	80	50	125	500	300	225	1000	170	660	400	360	75	19	30	0	80	1087	128	
	112M	"	"	"	"	"	"	"	"	"	"	"	"	"	"	"	"	68	1101	134	
	132S	3	"	"	"	"	"	"	1200	205	790	440	400	"	"	"	"	48	1190	139	
	132M	"	"	"	"	"	"	"	"	"	"	"	"	"	"	"	"	"	20	"	145
	160M	"	"	"	"	"	"	"	"	"	"	"	"	"	"	"	"	"	0	1325	206
	160L	"	"	"	"	"	"	"	"	"	"	"	"	"	"	"	"	"	"	"	216
	180M	4	"	"	"	"	"	"	1500	245	1010	480	440	"	"	"	"	"	"	1415	239
180L	"	"	"	"	"	"	"	"	"	"	"	"	"	"	"	"	"	"	1430	245	
200L	6	"	"	"	"	365	"	1300	215	870	510	460	"	24	13	45	25	1450	304		
225S	"	"	"	"	"	390	"	"	"	"	"	"	"	"	"	70	"	1529	345		
225M	"	"	"	"	"	"	"	"	"	"	"	"	"	"	"	"	"	"	"	381	
250M	7	"	"	"	"	415	"	1450	235	980	560	510	"	"	"	95	"	1559	416		
65-16	80	2	100	65	100	500	280	200	1000	170	660	400	360	75	19	30	0	80	976	177	
	90S	"	"	"	"	"	"	"	"	"	"	"	"	"	"	"	"	70	999	120	
	90L	"	"	"	"	"	"	"	"	"	"	"	"	"	"	"	"	"	1024	123	
	100L	"	"	"	"	"	"	"	"	"	"	"	"	"	"	"	"	"	60	1062	128
	132S	3	"	"	"	"	"	"	1200	205	790	440	400	"	"	"	"	28	1165	152	
	132M	"	"	"	"	"	"	"	"	"	"	"	"	"	"	"	"	"	"	"	152
	160M	"	"	"	"	"	"	"	"	"	"	"	"	"	"	"	"	0	1300	198	
160L	"	"	"	"	"	"	"	"	"	"	"	"	"	"	"	"	"	"	"	213	
65-20	90L	2	100	65	100	500	300	225	1000	170	660	400	360	75	19	30	0	90	1064	137	
	100L	3	"	"	"	"	"	"	1200	205	790	440	400	"	"	"	"	80	1102	142	
	112M	"	"	"	"	"	"	"	"	"	"	"	"	"	"	"	"	68	1116	149	
	132S	"	"	"	"	"	"	"	"	"	"	"	"	"	"	"	"	48	1205	159	
	132M	"	"	"	"	"	"	"	"	"	"	"	"	"	"	"	"	"	"	"	165
	160M	4	"	"	"	"	"	"	1500	245	1010	480	440	"	"	"	"	20	1340	211	
	160L	"	"	"	"	"	"	"	"	"	"	"	"	"	"	"	"	"	"	"	211
180M	"	"	"	"	"	"	"	"	"	"	"	"	"	"	"	"	0	1430	238		
180L	"	"	"	"	"	"	"	"	"	"	"	"	"	"	"	"	"	"	"	302	
200L	6	"	"	"	"	365	"	1300	215	870	510	460	"	24	19	45	25	1465	340		

POMPY SPECJALISTYCZNE

Typ pompy SRD D	Wielkość mechanicz. silnika	Typ płyty	Wymiary [mm]																	Masa [kg]	
			Ds	Dt	a	f	h3	h2	L1	L2	L3	B2	B3	w	d	b	c1	c2	T ⁽⁹⁾		
65-25	100L	3	100	65	125	500	320	250	1200	205	790	440	400	90	19	30	0	100	1127	159	
	112M	"	"	"	"	"	"	"	"	"	"	"	"	"	"	"	"	88	1141	166	
	132S	"	"	"	"	"	"	"	"	"	"	"	"	"	"	"	"	68	1230	175	
	132M	"	"	"	"	"	"	"	"	"	"	"	"	"	"	"	"	"	"	185	
	160M	4	"	"	"	"	"	"	1500	245	1010	480	440	"	"	"	"	40	1365	207	
	160L	"	"	"	"	"	"	"	"	"	"	"	"	"	"	"	"	"	"	1380	217
	180M	"	"	"	"	"	"	"	"	"	"	"	"	"	"	"	"	"	20	1455	248
	180L	"	"	"	"	"	"	"	"	"	"	"	"	"	"	"	"	"	"	"	260
	200L	"	"	"	"	"	"	"	"	"	"	"	"	"	"	"	"	"	0	1490	312
	225S	7	"	"	"	"	390	"	1450	235	980	560	510	"	24	13	50	25	1569	354	
	225M	"	"	"	"	"	"	"	"	"	"	"	"	"	"	"	"	"	"	"	378
250M	"	"	"	"	"	415	"	"	"	"	"	"	"	"	"	"	75	"	1650	420	
280S	8	"	"	"	"	445	"	1590	"	1120	"	"	"	"	"	"	105	"	1729	620	
65-31	132S	5	100	65	125	530	345	280	1200	205	790	505	65	90	19	30	0	93	1260	225	
	132M	"	"	"	"	"	"	"	"	"	"	"	"	"	"	"	"	"	"	235	
	160M	6	"	"	"	"	390	"	1300	215	870	510	460	"	24	13	25	90	1395	257	
	160L	"	"	"	"	"	"	"	"	"	"	"	"	"	"	"	"	"	"	"	272
	180M	7	"	"	"	"	"	"	1450	235	980	560	510	"	"	"	"	70	1485	315	
	180L	"	"	"	"	"	"	"	"	"	"	"	"	"	"	"	"	"	"	"	322
	200L	"	"	"	"	"	"	"	"	"	"	"	"	"	"	"	"	50	1570	391	
	225S	"	"	"	"	"	"	"	"	"	"	"	"	"	"	"	"	25	1630	442	
	225M	"	"	"	"	"	"	"	"	"	"	"	"	"	"	"	"	"	"	"	452
	250M	8	"	"	"	"	415	"	1590	"	1120	"	"	"	"	"	50	25	1670	490	
	280S	"	"	"	"	"	445	"	"	"	"	"	"	"	"	"	80	"	1855	660	
280M	"	"	"	"	"	"	"	"	"	"	"	"	"	"	"	"	"	"	"	725	
80-16	90S	2	125	80	125	500	300	225	1000	170	660	400	360	75	19	30	0	90	1064	1138	
	90L	"	"	"	"	"	"	"	"	"	"	"	"	"	"	"	"	"	"	1069	
	100L	3	"	"	"	"	"	"	1200	205	790	440	400	"	"	"	"	80	1127	146	
	112M	"	"	"	"	"	"	"	"	"	"	"	"	"	"	"	"	"	68	1141	149
	132S	"	"	"	"	"	"	"	"	"	"	"	"	"	"	"	"	"	48	1230	167
	132M	"	"	"	"	"	"	"	"	"	"	"	"	"	"	"	"	"	"	"	175
	160M	4	"	"	"	"	"	"	1500	245	1010	480	440	"	"	"	"	20	1365	220	
	160L	"	"	"	"	"	"	"	"	"	"	"	"	"	"	"	"	"	"	"	230
	180M	"	"	"	"	"	"	"	"	"	"	"	"	"	"	"	"	"	0	1455	247
	180L	"	"	"	"	"	"	"	"	"	"	"	"	"	"	"	"	"	"	"	257
	200L	6	"	"	"	"	365	"	1300	215	870	510	460	"	24	13	45	25	1490	327	
80-20	100L	3	125	80	125	500	300	250	1200	205	790	440	400	75	19	30	0	80	1127	154	
	112M	"	"	"	"	"	"	"	"	"	"	"	"	"	"	"	"	68	1141	161	
	132S	"	"	"	"	"	"	"	"	"	"	"	"	"	"	"	"	48	1230	172	
	132M	"	"	"	"	"	"	"	"	"	"	"	"	"	"	"	"	"	"	"	182
	160M	4	"	"	"	"	320	"	1500	245	1010	480	440	"	"	"	"	20	1365	204	
	160L	"	"	"	"	"	"	"	"	"	"	"	"	"	"	"	"	"	"	"	225
	180M	"	"	"	"	"	"	"	"	"	"	"	"	"	"	"	"	0	1455	252	
	180L	"	"	"	"	"	"	"	"	"	"	"	"	"	"	"	"	"	"	"	262
	200L	6	"	"	"	"	365	"	1300	215	870	510	460	"	24	13	45	25	1490	348	
	225S	7	"	"	"	"	390	"	1450	235	980	560	510	"	"	"	70	"	1569	392	
	225M	"	"	"	"	"	"	"	"	"	"	"	"	"	"	"	"	"	"	"	402
250M	"	"	"	"	"	415	"	"	"	"	"	"	"	"	"	95	"	1599	427		
80-25	112M	5	125	80	125	500	345	280	1200	205	790	505	465	90	19	30	0	113	1141	177	
	132S	"	"	"	"	"	"	"	"	"	"	"	"	"	"	"	"	93	1230	188	
	132M	"	"	"	"	"	"	"	"	"	"	"	"	"	"	"	"	"	"	198	
	160M	6	"	"	"	"	390	"	1300	215	870	510	460	"	24	13	25	90	1365	250	
	160L	"	"	"	"	"	"	"	"	"	"	"	"	"	"	"	"	"	"	"	280
	200L	7	"	"	"	"	"	"	1450	235	980	560	510	"	"	"	"	50	1490	330	
	225M	"	"	"	"	"	"	"	"	"	"	"	"	"	"	"	"	25	1569	420	
	250M	"	"	"	"	"	415	"	"	"	"	"	"	"	"	"	"	50	1599	437	
	280S	8	"	"	"	"	445	"	1590	"	1120	"	"	"	"	"	80	"	1729	505	
	80-31	132M	5	125	80	125	530	370	315	1200	205	790	505	465	90	19	13	0	118	1260	240
		160M	6	"	"	"	"	415	"	1300	215	870	510	460	"	24	30	25	115	1395	262
160L		"	"	"	"	"	"	"	"	"	"	"	"	"	"	"	"	"	"	277	
180M		7	"	"	"	"	"	"	1450	235	980	560	510	"	"	"	"	95	1485	320	
180L		"	"	"	"	"	"	"	"	"	"	"	"	"	"	"	"	"	"	"	345
250M		8	"	"	"	"	445	"	1590	"	1120	"	"	"	"	"	"	25	1629	490	
280S		"	"	"	"	"	"	"	"	"	"	"	"	"	"	"	55	"	1855	670	
280M		"	"	"	"	"	"	"	"	"	"	"	"	"	"	"	"	"	"	"	735
100-20		100L	3	125	100	125	500	320	280	1200	205	790	440	400	90	19	30	0	100	1127	170
		112M	"	"	"	"	"	"	"	"	"	"	"	"	"	"	"	"	88	1141	177
		132S	"	"	"	"	"	"	"	"	"	"	"	"	"	"	"	"	68	1230	188
	132M	"	"	"	"	"	"	"	"	"	"	"	"	"	"	"	"	"	"	198	
	160M	4	"	"	"	"	"	"	1500	255	1010	480	440	"	"	"	"	40	1365	220	
	160L	"	"	"	"	"	"	"	"	"	"	"	"	"	"	"	"	"	"	"	240
	180M	"	"	"	"	"	"	"	"	"	"	"	"	"	"	"	"	20	1455	270	
	180L	"	"	"	"	"	"	"	"	"	"	"	"	"	"	"	"	0	"	"	300
	200L	"	"	"	"	"	"	"	"	"	"	"	"	"	"	"	"	"	"	"	347
	225M	7	"	"	"	"	390	"	1450	235	980	560	510	"	24	13	50	25	1569	413	
	250M	"	"	"	"	"	415	"	"	"	"	"	"	"	"	"	75	"	1640	445	
280S	8	"	"	"	"	445	"	1590	"	1120	"	"	"	"	"	"	105	"	1825	625	

Typ pompy SRD D	Wielkość mechanicz. silnika	Typ płyty	Wymiary [mm]																	Masa [kg]	
			Ds	Dt	a	f	h3	h2	L1	L2	L3	B2	B3	w	d	b	c1	c2	T ⁽⁹⁾		
100-25	132S	5	125	100	125	530	345	280	1200	205	790	505	465	90	19	30	0	93	1275	217	
	132M	"	"	"	"	"	"	"	"	"	"	"	"	"	"	"	"	"	"	227	
	160M	6	"	"	"	"	390	"	1300	215	870	510	460	"	24	13	25	90	1410	249	
	160L	"	"	"	"	"	"	"	"	"	"	"	"	"	"	"	"	"	"	264	
	180M	7	"	"	"	"	"	"	1450	235	980	560	510	"	"	"	"	70	1500	309	
	180L	"	"	"	"	"	"	"	"	"	"	"	"	"	"	"	"	"	"	"	330
	200L	"	"	"	"	"	"	"	"	"	"	"	"	"	"	"	"	"	50	1580	385
	225M	"	"	"	"	"	"	"	"	"	"	"	"	"	"	"	"	25	1640	436	
	250M	8	"	"	"	"	415	"	1590	"	1120	"	"	"	"	"	"	50	1685	475	
	280S	"	"	"	"	"	445	"	"	"	"	"	"	"	"	"	"	80	1870	655	
280M	"	"	"	"	"	"	"	"	"	"	"	"	"	"	"	"	"	"	1870	720	
100-31	160M	6	125	100	140	530	415	315	1300	215	870	510	460	90	24	13	25	155	1410	269	
	160L	"	"	"	"	"	"	"	"	"	"	"	"	"	"	"	"	"	"	284	
	180M	7	"	"	"	"	"	"	1450	235	980	560	510	"	"	"	"	95	1500	329	
	180L	"	"	"	"	"	"	"	"	"	"	"	"	"	"	"	"	"	"	344	
	200L	"	"	"	"	"	"	"	"	"	"	"	"	"	"	"	"	75	1535	395	
	250M	8	"	"	"	"	"	"	1590	"	1120	"	"	"	"	"	"	25	1700	495	
	280S	"	"	"	"	"	445	"	"	"	"	"	"	"	"	"	"	55	1885	675	
	280M	"	"	"	"	"	"	"	"	"	"	"	"	"	"	"	"	"	"	740	
	315S	10	"	"	"	"	520	"	2000	260	1480	710	660	"	"	"	90	"	1980	950	
315M	"	"	"	"	"	"	"	"	"	"	"	"	"	"	"	"	"	"	980		
100-40	132M	6	125	100	140	530	445	355	1300	215	870	510	460	110	24	13	25	173	1290	280	
	160M	"	"	"	"	"	"	"	"	"	"	"	"	"	"	"	"	145	1410	305	
	160L	"	"	"	"	"	"	"	"	"	"	"	"	"	"	"	"	"	"	319	
	180M	7	"	"	"	"	"	"	1450	235	980	560	510	"	"	"	"	125	1500	364	
	180L	"	"	"	"	"	"	"	"	"	"	"	"	"	"	"	"	"	"	379	
	200L	"	"	"	"	"	"	"	"	"	"	"	"	"	"	"	"	105	1535	426	
	225S	"	"	"	"	"	"	"	"	"	"	"	"	"	"	"	"	80	1644	478	
	225M	"	"	"	"	"	"	"	"	"	"	"	"	"	"	"	"	"	"	513	
125-25	132M	5	150	125	140	530	370	355	1200	205	790	505	465	90	24	13	0	118	1275	249	
	160M	6	"	"	"	"	415	"	1300	215	870	510	460	"	"	"	25	115	1460	271	
	160L	"	"	"	"	"	"	"	"	"	"	"	"	"	"	"	"	"	"	286	
	180M	7	"	"	"	"	"	"	1450	235	980	560	510	"	"	"	"	95	1550	331	
	180L	"	"	"	"	"	"	"	"	"	"	"	"	"	"	"	"	"	"	346	
	200L	"	"	"	"	"	"	"	"	"	"	"	"	"	"	"	"	75	1585	355	
	225M	"	"	"	"	"	"	"	"	"	"	"	"	"	"	"	"	50	1694	425	
	250M	8	"	"	"	"	"	"	1590	"	1120	"	"	"	"	"	"	"	1750	500	
	280S	"	"	"	"	"	445	"	"	"	"	"	"	"	"	"	"	55	25	1935	680
	280M	"	"	"	"	"	"	"	"	"	"	"	"	"	"	"	"	"	"	745	
	315S	10	"	"	"	"	520	"	2000	260	1480	710	660	"	"	"	90	"	2030	955	
315M	"	"	"	"	"	"	"	"	"	"	"	"	"	"	"	"	"	"	985		
125-31	132S	6	150	125	140	530	445	355	1300	215	870	510	460	110	24	13	25	173	1275	277	
	132M	"	"	"	"	"	"	"	"	"	"	"	"	"	"	"	"	"	"	287	
	160M	"	"	"	"	"	"	"	"	"	"	"	"	"	"	"	"	145	1460	310	
	160L	"	"	"	"	"	"	"	"	"	"	"	"	"	"	"	"	"	"	355	
	180M	7	"	"	"	"	"	"	1450	235	980	560	510	"	"	"	"	125	1550	370	
	180L	"	"	"	"	"	"	"	"	"	"	"	"	"	"	"	"	"	"	417	
	200L	"	"	"	"	"	"	"	"	"	"	"	"	"	"	"	"	105	1585	469	
225S	"	"	"	"	"	"	"	"	"	"	"	"	"	"	"	"	80	1644	518		
125-40	132M	6	150	125	140	530	480	400	1300	215	870	510	460	110	24	13	25	208	1275	310	
	160M	"	"	"	"	"	"	"	"	"	"	"	"	"	"	"	"	180	1460	335	
	160L	"	"	"	"	"	"	"	"	"	"	"	"	"	"	"	"	"	"	370	
	180M	7	"	"	"	"	"	"	1450	235	980	560	510	"	"	"	"	160	1550	380	
	180L	"	"	"	"	"	"	"	"	"	"	"	"	"	"	"	"	"	"	393	
	200L	"	"	"	"	"	"	"	"	"	"	"	"	"	"	"	"	140	1585	440	
	225S	"	"	"	"	"	"	"	"	"	"	"	"	"	"	"	"	115	1644	492	
	225M	"	"	"	"	"	"	"	"	"	"	"	"	"	"	"	"	"	"	527	
	250M	8	"	"	"	"	"	"	1590	"	1120	"	"	"	"	"	"	90	1750	564	
	280S	"	"	"	"	"	"	"	"	"	"	"	"	"	"	"	"	60	1935	620	
280M	"	"	"	"	"	"	"	"	"	"	"	"	"	"	"	"	"	"	680		

POMPY SPECJALISTYCZNE

PARAMETRY TECHNICZNE

Pompy SRD L wspornikowe

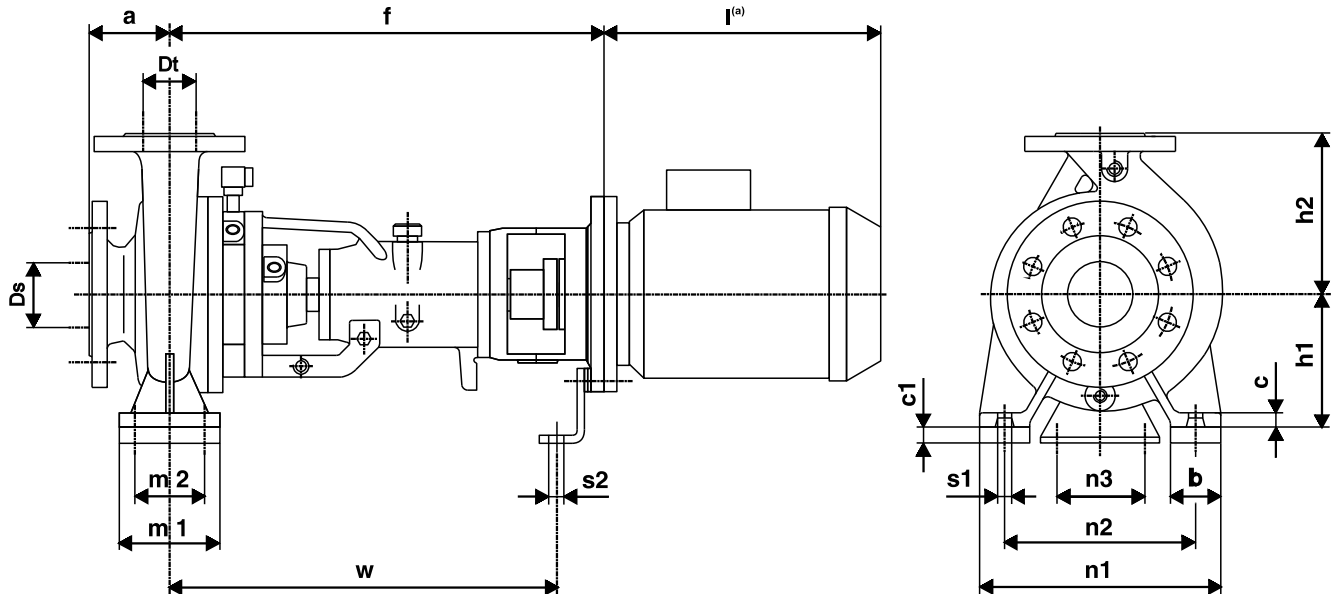

Wielkość mechaniczna silnika	Moc [kW]			L* [mm]	Masa [kg]
	n=2900min ⁻¹	n=1400min ⁻¹	n=950min ⁻¹		
80	0.75	0.55	0.37	232	9
80	1.1	0.75	0.55	232	10
90	1.5	1.1	0.75	270	13
90	2.2	1.5	1.1	270	16
100	3	2.2	1.5	298	21
100	-	3	-	298	23
112	4	4	2.2	312	30
132	5.5	5.5	3	381	40
132	7.5	7.5	4	381	50
132	9.2	9.2	5.5	381	50
160	11	11	7.5	486	76
160	15	15	11	486	85
160	18.5	-	-	486	95
180	22	18.5	15	576	130
180	-	22	-	576	145

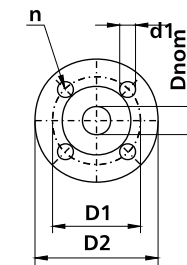

Dnom	32	40	50	65	80	100	125	150
D1	100	110	125	145	160	180	210	240
D2	140	150	165	185	200	220	250	285
d1	18	18	18	18	18	18	18	22
n	4	4	4	4	8	8	8	8

* wymiary i masa silnika zależne od dostawcy silnika

Typ pompy SRD L	Wielkość mechanicz. silnika	Wymiary [mm]																Masa [kg]	
		Ds	Dt	a	f	h1	h2	b	c	c1	m1	m2	n1	n2	n3	s1	s2		w
32-16	80	50	32	80	437	132	160	50	100	70	240	190	110	395	14	-	14	14	42
	90	"	"	"	437	"	"	"	"	"	"	"	"	"	"	"	"	"	42
	100	"	"	"	457	"	"	"	"	"	"	"	"	"	"	"	"	"	46
	112	"	"	"	457	"	"	"	"	"	"	"	"	"	"	"	"	"	46
	132	"	"	"	477	"	"	"	"	"	"	"	"	190	435	"	25	"	48
32-20	80	50	32	80	437	160	180	50	100	70	240	190	110	395	14	-	14	14	48
	90	"	"	"	437	"	"	"	"	"	"	"	"	"	"	"	"	"	48
	100	"	"	"	457	"	"	"	"	"	"	"	"	"	"	"	"	"	52
	112	"	"	"	457	"	"	"	"	"	"	"	"	"	"	"	"	"	52
	132	"	"	"	477	"	"	"	"	"	"	"	190	435	"	-	"	"	54
160	"	"	"	507	"	"	"	"	"	"	"	"	"	456	"	20	"	61	
40-16	80	65	40	80	437	132	160	50	100	70	240	190	110	395	14	-	14	14	43
	90	"	"	"	437	"	"	"	"	"	"	"	"	"	"	"	"	"	43
	100	"	"	"	457	"	"	"	"	"	"	"	"	"	"	"	"	"	47
	112	"	"	"	457	"	"	"	"	"	"	"	"	"	"	"	"	"	47
	132	"	"	"	477	"	"	"	"	"	"	"	"	190	435	"	25	"	49
160	"	"	"	507	"	"	"	"	"	"	"	"	"	"	"	50	"	56	

* Masa silników podana w tabeli dane elektryczne

Typ pompy SRD L	Wielkość mechanicz. silnika	Wymiary [mm]																Masa [kg]	
		Ds	Dt	a	f	h1	h2	b	c	c1	m1	m2	n1	n2	n3	s1	s2		w
40-20	80	65	40	100	437	160	180	50	100	70	265	212	110	395	14	-	14	14	47
	90	"	"	"	437	"	"	"	"	"	"	"	"	"	"	"	"	"	47
	100	"	"	"	457	"	"	"	"	"	"	"	"	"	"	"	"	"	51
	112	"	"	"	457	"	"	"	"	"	"	"	"	"	"	"	"	"	51
	132	"	"	"	477	"	"	"	"	"	"	"	190	437	"	-	"	"	53
160	"	"	"	507	"	"	"	"	"	"	"	"	456	"	20	"	"	60	
50-16	80	80	50	100	437	160	180	50	100	70	265	212	110	395	14	-	14	14	46
	90	"	"	"	437	"	"	"	"	"	"	"	"	"	"	"	"	"	46
	100	"	"	"	457	"	"	"	"	"	"	"	"	"	"	"	"	"	50
	112	"	"	"	457	"	"	"	"	"	"	"	"	"	"	"	"	"	50
	132	"	"	"	477	"	"	"	"	"	"	"	190	435	"	-	"	"	52
160	"	"	"	507	"	"	"	"	"	"	"	"	456	"	20	"	"	59	
50-20	90	80	50	100	437	160	200	50	100	70	265	212	110	395	14	-	14	14	51
	100	"	"	"	457	"	"	"	"	"	"	"	"	"	"	"	"	"	55
	112	"	"	"	457	"	"	"	"	"	"	"	"	"	"	"	"	"	55
	132	"	"	"	477	"	"	"	"	"	"	"	190	437	"	-	"	"	57
160	"	"	"	507	"	"	"	"	"	"	"	"	456	"	20	"	"	64	
50-25	100	80	50	125	563	180	225	65	125	95	320	250	110	516	16	-	16	14	80
	112	"	"	"	563	"	"	"	"	"	"	"	"	"	"	"	"	"	80
	132	"	"	"	583	"	"	"	"	"	"	"	190	543	"	-	"	"	84
	160	"	"	"	613	"	"	"	"	"	"	"	212	562	"	-	"	"	89
65-16	100	100	65	100	563	160	200	65	125	95	280	212	110	516	15	-	14	14	69
	112	"	"	"	563	"	"	"	"	"	"	"	"	"	"	"	"	"	69
	132	"	"	"	583	"	"	"	"	"	"	"	190	543	"	-	"	"	73
	160	"	"	"	613	"	"	"	"	"	"	"	212	562	"	20	"	"	78
65-20	100	100	65	100	563	180	225	65	125	95	320	250	110	516	16	-	14	14	77
	112	"	"	"	563	"	"	"	"	"	"	"	"	"	"	"	"	"	77
	132	"	"	"	583	"	"	"	"	"	"	"	190	543	"	-	"	"	81
	160	"	"	"	613	"	"	"	"	"	"	"	212	562	"	-	"	"	86
65-25	100	100	65	125	563	200	250	80	160	120	360	280	110	516	18	-	18	14	87
	112	"	"	"	563	"	"	"	"	"	"	"	"	"	"	"	"	"	87
	132	"	"	"	583	"	"	"	"	"	"	"	190	536	"	-	"	"	91
	160	"	"	"	613	"	"	"	"	"	"	"	212	568	"	-	"	"	96
65-31	112	100	65	125	598	225	280	80	160	120	400	315	110	549	18	-	18	14	125
	132	"	"	"	618	"	"	"	"	"	"	"	190	579	"	-	"	"	125
	160	"	"	"	648	"	"	"	"	"	"	"	212	598	"	-	"	"	130
	180	"	"	"	648	"	"	"	"	"	"	"	"	"	"	-	"	"	135
80-16	100	125	80	125	563	180	225	65	125	95	320	250	110	516	15	-	14	14	76
	112	"	"	"	563	"	"	"	"	"	"	"	"	"	"	"	"	"	76
	132	"	"	"	583	"	"	"	"	"	"	"	190	543	"	-	"	"	80
	160	"	"	"	613	"	"	"	"	"	"	"	212	562	"	-	"	"	85
80-20	100	125	80	125	563	180	250	65	125	95	345	280	110	516	16	-	14	14	81
	112	"	"	"	563	"	"	"	"	"	"	"	"	"	"	"	"	"	81
	132	"	"	"	583	"	"	"	"	"	"	"	190	543	"	-	"	"	85
	160	"	"	"	613	"	"	"	"	"	"	"	212	562	"	-	"	"	91
80-25	100	125	80	125	563	225	280	80	160	120	400	315	110	516	18	-	18	14	96
	112	"	"	"	563	"	"	"	"	"	"	"	"	"	"	"	"	"	96
	132	"	"	"	583	"	"	"	"	"	"	"	190	543	"	-	"	"	100
	160	"	"	"	613	"	"	"	"	"	"	"	212	562	"	-	"	"	105
80-31	112	125	80	125	598	250	315	80	160	120	400	315	110	549	18	-	18	14	139
	132	"	"	"	618	"	"	"	"	"	"	"	190	579	"	-	"	"	139
	160	"	"	"	648	"	"	"	"	"	"	"	212	598	"	-	"	"	143
	180	"	"	"	648	"	"	"	"	"	"	"	"	"	"	-	"	"	148
100-20	100	125	100	125	563	200	280	80	160	120	360	280	110	516	16	-	18	14	96
	112	"	"	"	563	"	"	"	"	"	"	"	"	"	"	"	"	"	96
	132	"	"	"	583	"	"	"	"	"	"	"	190	543	"	-	"	"	100
	160	"	"	"	613	"	"	"	"	"	"	"	212	562	"	-	"	"	105
	180	"	"	"	613	"	"	"	"	"	"	"	"	"	"	-	"	"	105
100-25	100	125	100	140	598	225	280	80	160	120	400	315	110	551	18	-	18	14	126
	112	"	"	"	598	"	"	"	"	"	"	"	"	"	"	"	"	"	126
	132	"	"	"	618	"	"	"	"	"	"	"	190	579	"	-	"	"	130
	160	"	"	"	648	"	"	"	"	"	"	"	212	594	"	-	"	"	135
	180	"	"	"	648	"	"	"	"	"	"	"	"	"	"	-	"	"	135
100-31	100	125	100	140	598	250	315	80	160	120	400	315	110	551	18	-	18	14	146
	112	"	"	"	598	"	"	"	"	"	"	"	"	"	"	"	"	"	146
	132	"	"	"	618	"	"	"	"	"	"	"	190	579	"	-	"	"	150
	160	"	"	"	648	"	"	"	"	"	"	"	212	594	"	-	"	"	155
	180	"	"	"	648	"	"	"	"	"	"	"	"	"	"	-	"	"	155
125-25	112	150	125	140	598	250	355	80	160	120	400	315	110	551	18	-	18	14	148
	132	"	"	"	618	"	"	"	"	"	"	"	190	579	"	-	"	"	152
	160	"	"	"	648	"	"	"	"	"	"	"	212	594	"	-	"	"	157
	180	"	"	"	648	"	"	"	"	"	"	"	"	"	"	-	"	"	157
125-31	112	150	125	140	598	280	355	100	200	150	500	400	110	551	20	-	23	14	164
	132	"	"	"	618	"	"	"	"	"	"	"	190	579	"	-	"	"	168
	160	"	"	"	648	"	"	"	"	"	"	"	212	594	"	-	"	"	173
	180	"	"	"	648	"	"	"	"	"	"	"	"	"	"	-	"	"	173

* Masa silników podana w tabeli dane elektryczne

POMPY SPECJALISTYCZNE

PARAMETRY TECHNICZNE

Pompy SRD P wspornikowe na płycie podstawy

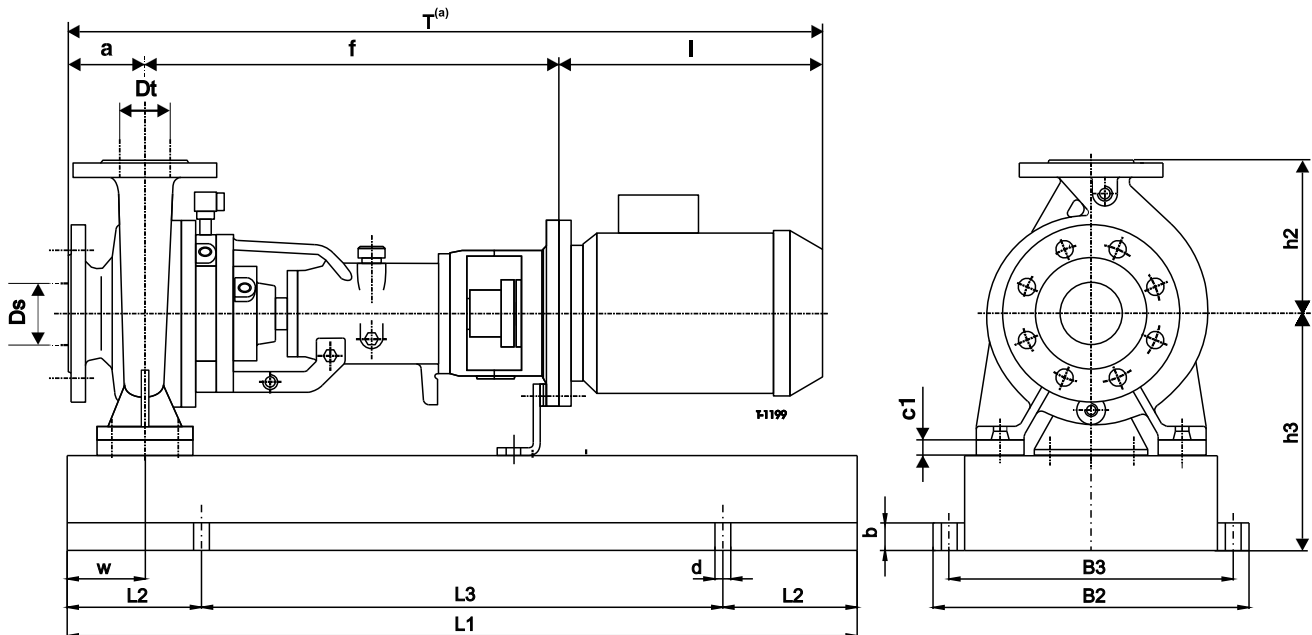

Wielkość mechaniczna silnika	Moc [kW]			L* [mm]	Masa [kg]
	n=2900min ⁻¹	n=1400min ⁻¹	n=950min ⁻¹		
80	0.75	0.55	0.37	232	9
80	1.1	0.75	0.55	232	10
90	1.5	1.1	0.75	270	13
90	2.2	1.5	1.1	270	16
100	3	2.2	1.5	298	21
100	-	3	-	298	23
112	4	4	2.2	312	30
132	5.5	5.5	3	381	40
132	7.5	7.5	4	381	50
132	9.2	9.2	5.5	381	50
160	11	11	7.5	486	76
160	15	15	11	486	85
160	18.5	-	-	486	95
180	22	18.5	15	576	130
180	-	22	-	576	145

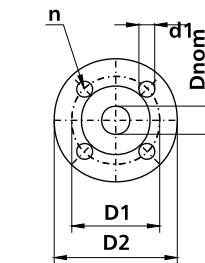

Wymiary przyłączy - PN10								
Dnom	32	40	50	65	80	100	125	150
D1	100	110	125	145	160	180	210	240
D2	140	150	165	185	200	220	250	285
d1	18	18	18	18	18	18	18	22
n	4	4	4	4	8	8	8	8

* wymiary i masa silnika zależne od dostawy silnika

Typ pompy SRD P	Wielkość mechanicz. silnika	Typ płyty	Wymiary [mm]																Masa [kg]	
			Ds	Dt	a	f	h2	h3	L1	L2	L3	B2	B3	w	d	b	c1	L ^(a)		T ^(a)
32-16	80	G1	50	32	80	437	160	202	650	100	450	350	320	90	14	4	-	224	741	71
	90	"	"	"	"	437	"	"	"	"	"	"	"	"	"	"	-	247	764	83
	100	"	"	"	"	457	"	"	"	"	"	"	"	"	"	"	-	290	827	97
	112	"	"	"	"	457	"	"	"	"	"	"	"	"	"	"	-	304	841	112
	132	"	"	"	"	477	"	227	"	"	"	"	"	"	"	"	25	373	930	158
32-20	80	G1	50	32	80	437	180	250	650	100	450	350	320	90	14	4	-	224	741	78
	90	"	"	"	"	437	"	"	"	"	"	"	"	"	"	"	-	247	764	90
	100	"	"	"	"	457	"	"	"	"	"	"	"	"	"	"	-	290	827	103
	112	"	"	"	"	457	"	"	"	"	"	"	"	"	"	"	-	304	841	128
	132	"	"	"	"	477	"	"	"	"	"	"	"	"	"	"	-	373	930	164
40-16	80	G1	65	40	80	437	160	202	650	100	452	350	320	90	14	4	-	224	741	74
	90	"	"	"	"	437	"	"	"	"	"	"	"	"	"	"	-	247	764	86
	100	"	"	"	"	457	"	"	"	"	"	"	"	"	"	"	-	290	827	100
	112	"	"	"	"	457	"	"	"	"	"	"	"	"	"	"	-	304	841	114
	132	"	"	"	"	477	"	227	"	"	"	"	"	"	"	"	25	373	930	164
160	"	"	"	"	507	"	"	"	"	"	"	"	"	"	"	50	478	1065	255	

* Masa silników podana w tabeli dane elektryczne

Typ pompy SRD P	Wielkość mechanicz. silnika	Typ płyty	Wymiary [mm]															Masa [kg]		
			Ds	Dt	a	f	h2	h3	L1	L2	L3	B2	B3	w	d	b	c1			L ^(*)
40-20	80	G1	65	40	100	437	180	230	650	100	450	350	320	90	14	4	-	224	761	77
	90	"	"	"	"	437	"	"	"	"	"	"	"	"	"	"	-	272	809	89
	100	"	"	"	"	457	"	"	"	"	"	"	"	"	"	"	-	290	847	107
	112	"	"	"	"	457	"	"	"	"	"	"	"	"	"	"	-	304	861	121
	132	"	"	"	"	477	"	"	"	"	"	"	"	"	"	"	-	373	950	163
	160	"	"	"	"	507	"	250	"	"	"	"	"	"	"	20	-	478	1085	250
50-16	80	G1	80	50	100	437	180	230	650	100	450	350	320	90	14	4	-	224	761	76
	90	"	"	"	"	437	"	"	"	"	"	"	"	"	"	"	-	272	809	88
	100	"	"	"	"	457	"	"	"	"	"	"	"	"	"	"	-	290	847	106
	112	"	"	"	"	457	"	"	"	"	"	"	"	"	"	"	-	304	861	120
	132	"	"	"	"	477	"	"	"	"	"	"	"	"	"	"	-	373	950	162
	160	"	"	"	"	507	"	250	"	"	"	"	"	"	"	20	-	478	1085	249
50-20	90	G1	80	50	100	437	200	230	650	100	450	350	320	90	14	4	-	272	809	80
	100	"	"	"	"	457	"	"	"	"	"	"	"	"	"	"	-	290	847	92
	112	"	"	"	"	457	"	"	"	"	"	"	"	"	"	"	-	304	861	100
	132	"	"	"	"	477	"	"	"	"	"	"	"	"	"	"	-	373	950	144
	160	"	"	"	"	507	"	250	"	"	"	"	"	"	"	"	20	-	478	1085
50-25	100	G2	80	50	125	563	225	250	850	150	550	510	460	120	16	6	-	299	987	146
	112	"	"	"	"	563	"	"	"	"	"	"	"	"	"	"	-	312	1000	160
	132	"	"	"	"	583	"	"	"	"	"	"	"	"	"	"	-	382	1090	204
	160	"	"	"	"	613	"	"	"	"	"	"	"	"	"	"	-	487	1225	290
65-16	100	G2	100	65	100	563	200	230	850	150	550	510	460	120	16	6	-	299	962	123
	112	"	"	"	"	563	"	"	"	"	"	"	"	"	"	"	-	324	987	136
	132	"	"	"	"	583	"	"	"	"	"	"	"	"	"	"	-	382	1065	193
	160	"	"	"	"	613	"	"	"	"	"	"	"	"	"	"	20	-	487	1200
65-20	100	G2	100	65	100	563	225	250	850	150	550	510	460	120	16	6	-	299	962	131
	112	"	"	"	"	563	"	"	"	"	"	"	"	"	"	"	-	324	987	144
	132	"	"	"	"	583	"	"	"	"	"	"	"	"	"	"	-	382	1065	201
	160	"	"	"	"	613	"	"	"	"	"	"	"	"	"	"	-	487	1200	278
65-25	100	G2	100	65	125	563	250	270	850	150	550	510	460	120	16	6	-	299	987	141
	112	"	"	"	"	563	"	"	"	"	"	"	"	"	"	"	-	312	1000	154
	132	"	"	"	"	583	"	"	"	"	"	"	"	"	"	"	-	382	1090	211
	160	"	"	"	"	613	"	"	"	"	"	"	"	"	"	"	-	487	1225	285
65-31	112	G3	100	65	125	598	280	325	1000	200	600	650	590	140	20	8	-	307	1030	173
	132	"	"	"	"	618	"	"	"	"	"	"	"	"	"	"	-	377	1120	202
	160	"	"	"	"	648	"	"	"	"	"	"	"	"	"	"	-	482	1255	255
	180	"	"	"	"	"	"	"	"	"	"	"	"	"	"	"	-	572	1345	320
80-16	100	G2	125	80	125	563	225	250	850	150	550	510	460	120	16	6	-	299	987	136
	112	"	"	"	"	563	"	"	"	"	"	"	"	"	"	"	-	312	1000	150
	132	"	"	"	"	583	"	"	"	"	"	"	"	"	"	"	-	382	1090	200
	160	"	"	"	"	613	"	"	"	"	"	"	"	"	"	"	-	577	1315	285
80-20	100	G2	125	80	125	563	250	250	850	150	550	510	460	120	16	6	-	299	987	140
	112	"	"	"	"	563	"	"	"	"	"	"	"	"	"	"	-	312	1000	154
	132	"	"	"	"	583	"	"	"	"	"	"	"	"	"	"	-	382	1090	204
	160	"	"	"	"	613	"	"	"	"	"	"	"	"	"	"	-	577	1315	289
80-25	100	G2	125	80	125	563	280	295	850	150	550	510	460	120	16	6	-	299	987	155
	112	"	"	"	"	563	"	"	"	"	"	"	"	"	"	"	-	312	1000	169
	132	"	"	"	"	583	"	"	"	"	"	"	"	"	"	"	-	382	1090	219
	160	"	"	"	"	613	"	"	"	"	"	"	"	"	"	"	-	577	1315	304
80-31	112	G3	125	80	125	598	315	350	1000	200	600	650	590	140	20	8	-	307	1030	205
	132	"	"	"	"	618	"	"	"	"	"	"	"	"	"	"	-	377	1120	232
	160	"	"	"	"	648	"	"	"	"	"	"	"	"	"	"	-	482	1255	310
	180	"	"	"	"	"	"	"	"	"	"	"	"	"	"	"	-	572	1345	400
100-20	100	G2	125	100	125	563	280	270	850	150	550	510	460	120	16	6	-	299	987	155
	112	"	"	"	"	563	"	"	"	"	"	"	"	"	"	"	-	312	1000	169
	132	"	"	"	"	583	"	"	"	"	"	"	"	"	"	"	-	382	1090	269
	160	"	"	"	"	613	"	"	"	"	"	"	"	"	"	"	-	577	1315	304
	180	"	"	"	"	613	"	"	"	"	"	"	"	"	"	"	-	577	"	414
100-25	100	G3	125	100	140	598	280	325	1000	200	600	650	590	140	20	8	-	282	1020	185
	112	"	"	"	"	598	"	"	"	"	"	"	"	"	"	"	-	302	1040	200
	132	"	"	"	"	618	"	"	"	"	"	"	"	"	"	"	-	377	1135	250
	160	"	"	"	"	648	"	"	"	"	"	"	"	"	"	"	-	482	1270	335
	180	"	"	"	"	648	"	"	"	"	"	"	"	"	"	"	-	572	1360	445
100-31	100	G3	125	100	140	598	315	350	1000	200	600	650	590	140	20	8	-	282	1020	305
	112	"	"	"	"	598	"	"	"	"	"	"	"	"	"	"	-	302	1040	220
	132	"	"	"	"	618	"	"	"	"	"	"	"	"	"	"	-	377	1135	270
	160	"	"	"	"	648	"	"	"	"	"	"	"	"	"	"	-	482	1270	355
	180	"	"	"	"	648	"	"	"	"	"	"	"	"	"	"	-	572	1360	465
125-25	112	G3	150	125	140	598	355	350	1000	200	600	650	590	140	20	8	-	302	1040	220
	132	"	"	"	"	618	"	"	"	"	"	"	"	"	"	"	-	377	1135	270
	160	"	"	"	"	648	"	"	"	"	"	"	"	"	"	"	-	482	1270	355
	180	"	"	"	"	648	"	"	"	"	"	"	"	"	"	"	-	572	1360	465
125-31	112	G3	150	125	140	598	355	380	1000	200	600	650	590	140	20	8	-	302	1040	233
	132	"	"	"	"	618	"	"	"	"	"	"	"	"	"	"	-	377	1135	270
	160	"	"	"	"	648	"	"	"	"	"	"	"	"	"	"	-	482	1270	330
	180	"	"	"	"	648	"	"	"	"	"	"	"	"	"	"	-	572	1360	485

* Masa silników podana w tabeli dane elektryczne

POMPY SPECJALISTYCZNE

PARAMETRY TECHNICZNE

Pompy SRD M monoblokowa

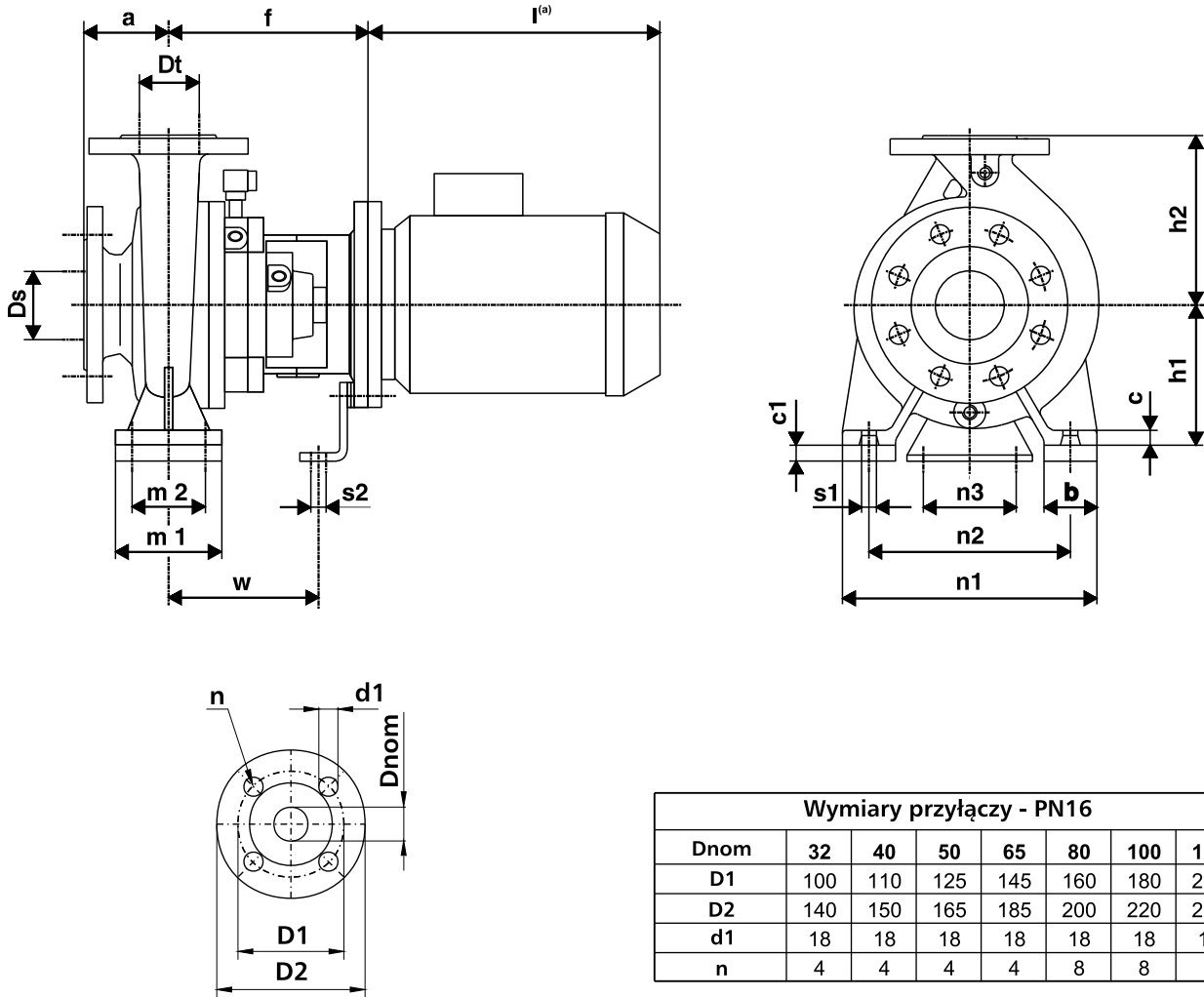

Wymiary przyłączy - PN16							
Dnom	32	40	50	65	80	100	125
D1	100	110	125	145	160	180	210
D2	140	150	165	185	200	220	250
d1	18	18	18	18	18	18	18
n	4	4	4	4	8	8	8

Wielkość mechaniczna silnika	Moc [kW]			L* [mm]	Masa [kg]
	n=2900min ⁻¹	n=1400min ⁻¹	n=950min ⁻¹		
80	0.75	0.55	0.37	232	9
80	1.1	0.75	0.55	232	10
90	1.5	1.1	0.75	270	13
90	2.2	1.5	1.1	270	16
100	3	2.2	1.5	298	21
100	-	3	-	298	23
112	4	4	2.2	312	30
132	5.5	5.5	3	381	40
132	7.5	7.5	4	381	50
132	9.2	9.2	5.5	381	50
160	11	11	7.5	486	76
160	15	15	11	486	85
160	18.5	-	-	486	95
180	22	18.5	15	576	130
180	-	22	-	576	145

* wymiary i masa silnika zależne od dostawcy silnika

Typ pompy SRD M	Wielkość mechanicz. silnika	Wymiary [mm]																	Masa [kg]
		Ds	Dt	a	f	h1	h2	b	m1	m2	n1	n2	n3	c	c1	s1	s2	w	
32-16	80	50	32	80	192	132	160	50	100	70	240	190	110	150	14	0	14	14	29
	90	"	"	"	"	"	"	"	"	"	"	"	"	"	"	"	"	"	29
	100	"	"	"	212	"	"	"	"	"	"	"	"	"	"	"	"	"	32
	112	"	"	"	"	"	"	"	"	"	"	"	"	"	"	"	"	"	32
	132	"	"	"	232	"	"	"	"	"	"	"	190	192	"	25	"	"	34
32-20	80	50	32	80	192	160	180	50	100	70	240	190	110	150	14	0	14	14	35
	90	"	"	"	"	"	"	"	"	"	"	"	"	"	"	"	"	"	35
	100	"	"	"	212	"	"	"	"	"	"	"	"	"	"	"	"	"	38
	112	"	"	"	"	"	"	"	"	"	"	"	"	"	"	"	"	"	38
	132	"	"	"	232	"	"	"	"	"	"	"	190	192	"	"	"	"	40
	160	"	"	"	262	"	"	"	"	"	"	"	"	"	"	20	"	"	48
40-16	80	65	40	80	192	132	160	50	100	70	240	190	110	150	14	0	14	14	30
	90	"	"	"	"	"	"	"	"	"	"	"	"	"	"	"	"	"	30
	100	"	"	"	212	"	"	"	"	"	"	"	"	"	"	"	"	"	33
	112	"	"	"	"	"	"	"	"	"	"	"	"	"	"	"	"	"	33
	132	"	"	"	232	"	"	"	"	"	"	"	190	192	"	25	"	"	35
	160	"	"	"	262	"	"	"	"	"	"	"	"	"	"	50	"	"	43
40-20	80	65	40	100	192	160	180	50	100	70	265	212	110	150	14	0	14	14	34
	90	"	"	"	"	"	"	"	"	"	"	"	"	"	"	"	"	"	34
	100	"	"	"	212	"	"	"	"	"	"	"	"	"	"	"	"	"	37
	112	"	"	"	"	"	"	"	"	"	"	"	"	"	"	"	"	"	37
	132	"	"	"	232	"	"	"	"	"	"	"	190	192	"	"	"	"	39
	160	"	"	"	262	"	"	"	"	"	"	"	"	211	"	20	"	"	47
50-16	80	80	50	100	192	160	180	50	100	70	265	212	110	150	14	-	14	14	33
	90	"	"	"	"	"	"	"	"	"	"	"	"	"	"	-	"	"	33
	100	"	"	"	212	"	"	"	"	"	"	"	"	"	"	-	"	"	36
	112	"	"	"	"	"	"	"	"	"	"	"	"	"	"	-	"	"	36
	132	"	"	"	232	"	"	"	"	"	"	"	190	192	"	-	"	"	38
	160	"	"	"	262	"	"	"	"	"	"	"	"	211	"	20	"	"	46
50-20	90	80	50	100	192	160	180	50	100	70	265	212	110	150	14	-	14	14	38
	100	"	"	"	212	"	"	"	"	"	"	"	"	"	"	-	"	"	41
	112	"	"	"	"	"	"	"	"	"	"	"	"	"	"	-	"	"	41
	132	"	"	"	232	"	"	"	"	"	"	"	190	192	"	-	"	"	43
	160	"	"	"	262	"	"	"	"	"	"	"	"	211	"	20	"	"	51
50-25	100	80	50	125	247	180	225	65	125	95	320	250	110	200	16	-	16	14	58
	112	"	"	"	"	"	"	"	"	"	"	"	"	"	"	-	"	"	58
	132	"	"	"	267	"	"	"	"	"	"	"	190	228	"	-	"	"	62
	160	"	"	"	297	"	"	"	"	"	"	"	212	246	"	-	"	"	69
65-16	100	100	65	100	247	160	200	65	125	95	280	212	110	200	15	-	14	14	47
	112	"	"	"	"	"	"	"	"	"	"	"	"	"	"	-	"	"	47
	132	"	"	"	267	"	"	"	"	"	"	"	190	228	"	-	"	"	51
	160	"	"	"	297	"	"	"	"	"	"	"	"	246	"	20	"	"	58
65-20	100	100	65	100	247	180	225	65	125	95	320	250	110	200	16	-	14	14	55
	112	"	"	"	"	"	"	"	"	"	"	"	"	"	"	-	"	"	55
	132	"	"	"	267	"	"	"	"	"	"	"	190	228	"	-	"	"	59
	160	"	"	"	297	"	"	"	"	"	"	"	212	246	"	-	"	"	66
65-25	100	100	65	125	247	200	250	80	160	120	360	280	110	200	18	-	18	14	65
	112	"	"	"	"	"	"	"	"	"	"	"	"	"	"	-	"	"	65
	132	"	"	"	267	"	"	"	"	"	"	"	190	228	"	-	"	"	69
	160	"	"	"	297	"	"	"	"	"	"	"	212	246	"	-	"	"	76
80-16	100	125	80	125	247	180	225	65	125	95	320	250	110	200	15	-	14	14	54
	112	"	"	"	"	"	"	"	"	"	"	"	"	"	"	-	"	"	54
	132	"	"	"	267	"	"	"	"	"	"	"	190	228	"	-	"	"	58
	160	"	"	"	297	"	"	"	"	"	"	"	212	246	"	-	"	"	65
80-20	100	125	80	125	247	180	250	65	125	95	345	280	110	200	16	-	14	14	59
	112	"	"	"	"	"	"	"	"	"	"	"	"	"	"	-	"	"	59
	132	"	"	"	267	"	"	"	"	"	"	"	190	228	"	-	"	"	63
	160	"	"	"	297	"	"	"	"	"	"	"	212	246	"	-	"	"	70
80-25	100	125	80	125	247	225	280	80	160	120	400	315	110	200	18	-	18	14	74
	112	"	"	"	"	"	"	"	"	"	"	"	"	"	"	-	"	"	74
	132	"	"	"	267	"	"	"	"	"	"	"	190	228	"	-	"	"	78
	160	"	"	"	297	"	"	"	"	"	"	"	212	246	"	-	"	"	85
100-20	100	125	100	125	247	200	280	80	160	120	360	280	110	200	16	-	18	14	74
	112	"	"	"	"	"	"	"	"	"	"	"	"	"	"	-	"	"	74
	132	"	"	"	267	"	"	"	"	"	"	"	190	228	"	-	"	"	78
	160	"	"	"	297	"	"	"	"	"	"	"	212	246	"	-	"	"	85
	180	"	"	"	"	"	"	"	"	"	"	"	"	"	"	-	"	"	85
100-25	100	125	100	140	282	225	280	80	160	120	400	315	110	235	18	-	18	14	94
	112	"	"	"	282	"	"	"	"	"	"	"	"	"	"	-	"	"	94
	132	"	"	"	302	"	"	"	"	"	"	"	190	255	"	-	"	"	98
	160	"	"	"	332	"	"	"	"	"	"	"	212	287	"	-	"	"	105
	180	"	"	"	"	"	"	"	"	"	"	"	"	"	"	-	"	"	105

* Masa silników podana w tabeli dane elektryczne

