

Bourdon tube pressure gauge with electrical output signal Stainless steel, safety version, NS 63 Model PGT23.063

WIKA data sheet PV 12.03



for further approvals
see page 4

intelliGAUGE®

Applications

- Acquisition and display of process values
- Output signal 4 ... 20 mA for the transmission of process values to the control room
- Easy-to-read, analogue on-site display needing no external power
- Safety-related applications

Special features

- No configuration necessary due to "plug-and-play"
- Measuring ranges from 0 ... 1 bar to 0 ... 1,000 bar
- Easy-to-read analogue display with nominal size 63
- Safety pressure gauge S3 per EN 837-1



intelliGAUGE model PGT23.063

Description

Wherever the process pressure has to be indicated locally under limited space conditions and, at the same time, a signal transmission to the central control or remote centre is desired, the model PGT23.063 intelliGAUGE (patents applied for, among others Europ. patent no. EP 061 13003) can be used.

Through the combination of a mechanical measuring system and precise electronic signal processing, the process pressure can be read securely, even if the voltage supply is lost.

The intelliGAUGE model PGT23.063 fulfils all safety-related requirements of the relevant standards and regulations for the on-site display of the working pressure of pressure vessels. An additional measuring point for mechanical pressure display can thus be saved.

The model PGT23.063 is based upon a model 23X.30 high-quality, stainless steel safety pressure gauge with a nominal size of 63. The pressure measuring instrument is manufactured in accordance with EN 837-1.

The all welded and robust Bourdon tube measuring system produces a pointer rotation proportional to the pressure. An electronic angle encoder, proven in safety-critical automotive applications, determines the position of the pointer shaft – it is a non-contact sensor and therefore completely free from wear and friction. From this, the electrical output signal proportional to the pressure, 4 ... 20 mA, is produced.

The electronic WIKA sensor, integrated into the high-quality pressure gauge, combines the advantages of electrical signal transmission with the advantages of a local mechanical display.

The measuring span (electrical output signal) is adjusted automatically along with the mechanical display, i.e. the scale over the full measuring range corresponds to 4 ... 20 mA.

Specifications

Mechanical data	
Mechanical version	Safety version S3 with solid baffle wall per EN 837-1
Nominal size in mm	63
Accuracy ¹⁾ (mechanical display)	≤ 1.6 % of measuring span (class 1.6 per EN 837-1)
Scale ranges	0 ... 1 bar to 0 ... 1,000 bar; -1 ... 0 bar; -1 ... +25 bar or all other equivalent vacuum or combined pressure and vacuum ranges
Process connection	Stainless steel 316L, G ¼ B (male) (others as options)
Pressure limitation ²⁾	
Steady	3/4 x full scale value
Fluctuating	2/3 x full scale value
Short time	Full scale value
Pressure element	Stainless steel 316L C-type or helical type
Movement	Brass
Dial	Aluminium, white, black lettering
Pointer	Aluminium, black
Case	Stainless steel, safety version with solid baffle wall (Solidfront) and blow-out back, scale ranges ≤ 0 ... 16 bar with compensating valve to vent case
Window	<ul style="list-style-type: none"> ■ Polycarbonate ■ Laminated safety glass
Ring	Bayonet ring, stainless steel
Damping options	
For dynam. pressure load	Restrictor in the pressure port
For vibration	Liquid filling of the case
Permissible temperature range	
Medium	-40... +100 °C
Ambient	-20 ... +60 °C (with window from polycarbonate max. 80 °C)
Temperature effect	max. ±0.8 %/10 K of full scale value (when the temperature deviates from 20 °C reference temperature)
Case ingress protection	IP54 per IEC/EN 60529 (with liquid filling IP65)

1) For technical reasons, up to the first scale marking, the measured value can lie outside of the class accuracy

2) The recommendations for the use of mechanical pressure measuring systems in accordance with EN 837-1 must be observed

Options

- Other process connection
- Inverted electrical output signal
- Electrical connection via miniature connector M8 x 1, 4-pin (cable plug with 5 m cable length)
- Other cable length, flying leads
- Diaphragm seal assembly
- Filling liquid silicone M50 (only in connection with miniature connector)
- Panel mounting flange, stainless steel or polished stainless steel
- Surface mounting lugs on the back, stainless steel
- Window from laminated safety glass (max. ambient temperature 60 °C)

Electrical data																
Power supply U_B	DC $12 < U_B \leq 30$ V															
Influence of power supply	< 0.1 % of FS/10 V															
Permissible residual ripple	< 10 % ss															
Output signal	4 ... 20 mA, 2-wire															
Permissible max. load R_A	$R_A \leq (U_B - 12 \text{ V})/0.02 \text{ A}$ with R_A in Ohm and U_B in Volt, however max. 600 Ω															
Effect of load	≤ 0.1 % of FS															
Accuracy																
Long-term stability of electronics	< 0.5 % of FS/a															
Electr. output signal	≤ 1.6 % of measuring span															
Linear error	≤ 1.6 % of measuring span (terminal method) ¹⁾															
Electrical connection	<ul style="list-style-type: none"> ■ 2 m cable, flying leads ■ 5 m cable, flying leads ■ Miniature connector M8 x 1, 4-pin 															
Ingress protection	IP54 per IEC/EN 60529, filled IP65															
Cable assignment	<table border="1"> <thead> <tr> <th>Cable</th> <th>Connector</th> <th>Meaning</th> </tr> </thead> <tbody> <tr> <td>red</td> <td>Pin 1</td> <td>U_B+ / Sig +</td> </tr> <tr> <td>black</td> <td>Pin 4</td> <td>0 V / Sig -</td> </tr> <tr> <td>brown</td> <td>Pin 2</td> <td>n.c.</td> </tr> <tr> <td>- - -</td> <td>Pin 3</td> <td>n.c.</td> </tr> </tbody> </table>	Cable	Connector	Meaning	red	Pin 1	U_B + / Sig +	black	Pin 4	0 V / Sig -	brown	Pin 2	n.c.	- - -	Pin 3	n.c.
Cable	Connector	Meaning														
red	Pin 1	U_B + / Sig +														
black	Pin 4	0 V / Sig -														
brown	Pin 2	n.c.														
- - -	Pin 3	n.c.														

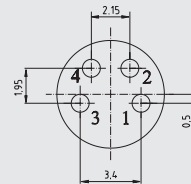

1) For technical reasons, up to the first scale marking, the measured value can lie outside of the class accuracy





Cable connection



Miniature connector (option)



Approvals

Logo	Description	Country
	EU declaration of conformity <ul style="list-style-type: none"> ■ EMC directive ■ Pressure equipment directive 	European Union
	EAC (option) <ul style="list-style-type: none"> ■ EMC directive ■ Pressure equipment directive 	Eurasian Economic Community
	GOST (option) Metrology, measurement technology	Russia
-	MTSCHS (option) Permission for commissioning	Kazakhstan
	BelGIM (option) Metrology, measurement technology	Belarus
	Uzstandard (option) Metrology, measurement technology	Uzbekistan
-	CRN Safety (e.g. electr. safety, overpressure, ...)	Canada

Certificates (option)

- 2.2 test report per EN 10204 (e.g. state-of-the-art manufacturing, indication accuracy)
- 3.1 inspection certificate per EN 10204 (e.g. indication accuracy)

Approvals and certificates, see website

Dimensions in mm

Standard version

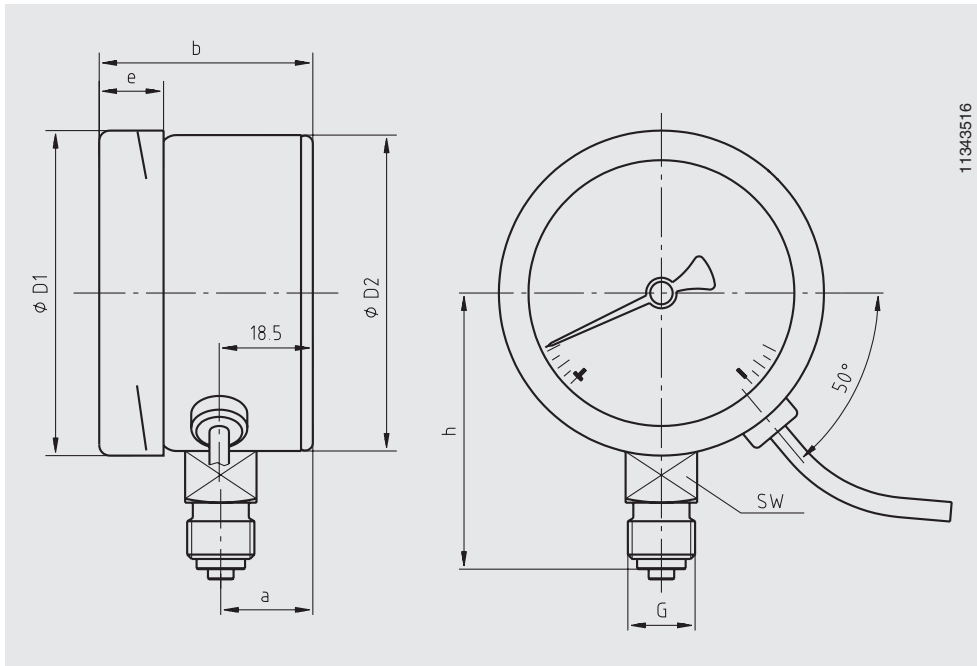

NS	Dimensions in mm								Weight in kg
	a	b	D ₁	D ₂	e	G	h±1	SW	
63	18	42	63	62	14.5	G ¼ B	54	14	0.25

Ordering information

Model / Scale range / Process connection / Connection location / Output signal / Options

© 05/2008 WIKA Alexander Wiegand SE & Co. KG, all rights reserved.
 The specifications given in this document represent the state of engineering at the time of publishing.
 We reserve the right to make modifications to the specifications and materials.

