

3 WAYS BRASS BALL VALVE PN16 THREADED



Size : DN 1/4" to 2"
Ends : Threaded Female BSP
Min Temperature : -10°C
Min Temperature : + 120°C
Max Pressure : 16 Bars
Specifications : PTFE packing + 2 NBR o-ring
2 Positions
Tightness on 3 ways

Materials : Brass

3 WAYS BRASS BALL VALVE PN16 THREADED

SPECIFICATIONS :

- Reduced bore
- 2 Positions
- PTFE packing + 2 NBR o-ring
- Tightness on 3 ways
- L or T port

USE :

- For all common fluids
- Min and max Temperature Ts : -10°C to + 120°C
- Max Pressure PN : 16 bars (see graph)
- Differential pressure : 5 bars maxi

PRESSURE / TEMPERATURE GRAPH (STEAM EXCLUDED) :

PRESSURE

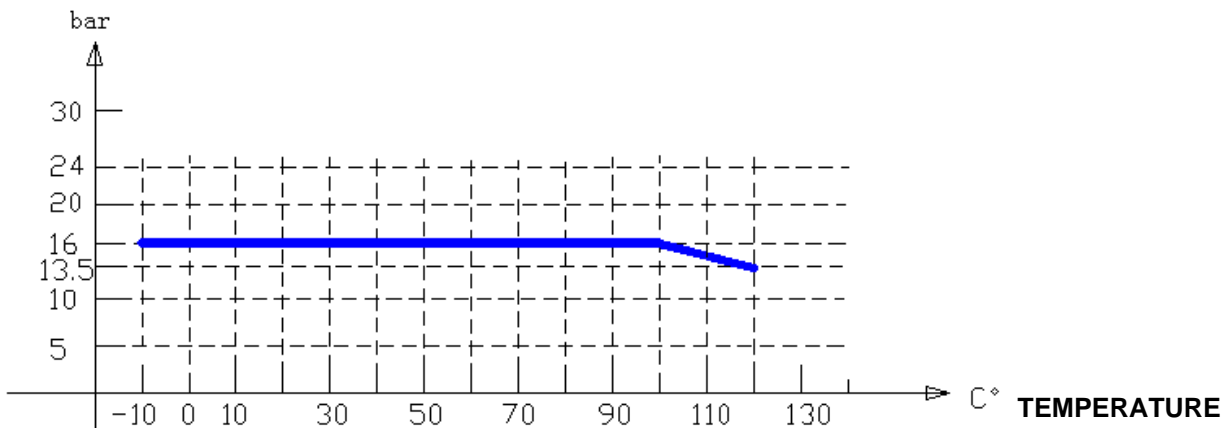

RANGE :

- Threaded female BSP cylindric, L port **Ref. 513** from DN 1/4" to 2"
- Threaded female BSP cylindric, T port **Ref. 514** from DN 1/4" to 2"

ENDS :

- Threaded BSP female cylindric ends

3 WAYS BRASS BALL VALVE PN16 THREADED

MATERIALS :

DN 1/4" – 3/4"

DN 1" – 2"

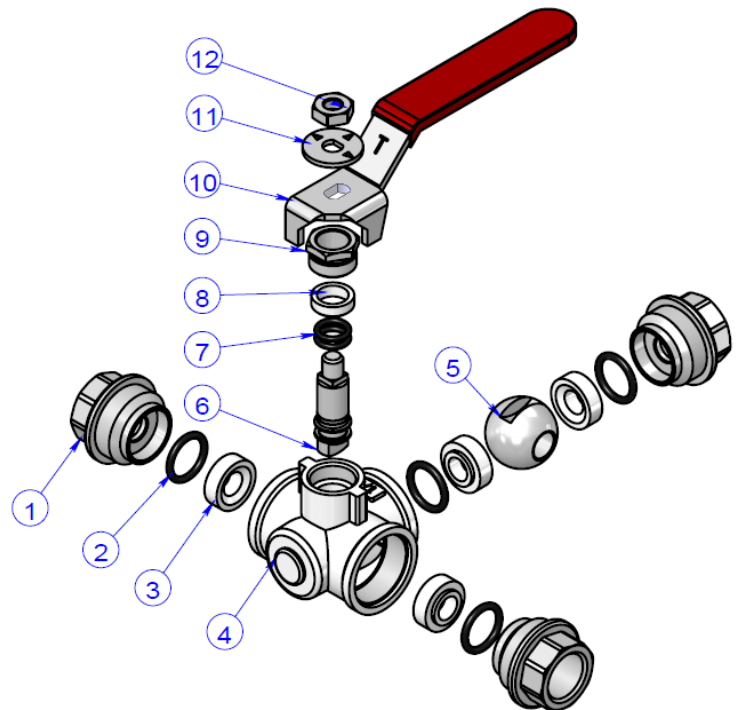
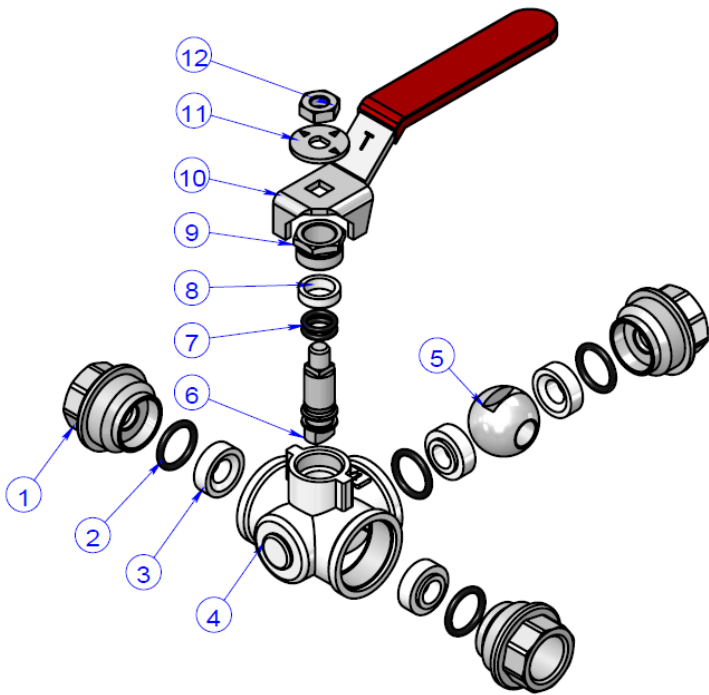



Item	Designation	Materials
1	Bonnet	Brass
2	O ring	NBR
3	Seat	PTFE
4	Body	Brass
5	Ball	Brass
6	Stem	Brass
7	O ring	NBR
8	Packing	PTFE
9	Packing nut	Brass
10	Handle	Steel
11	Washer	Aluminium
12	Handle nut	Steel

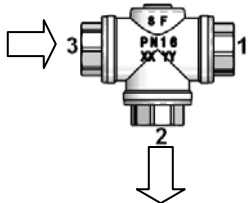
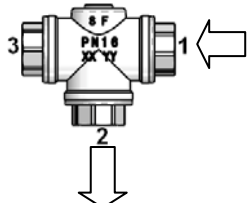
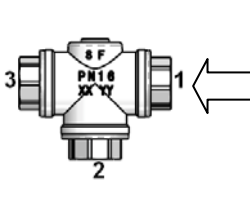
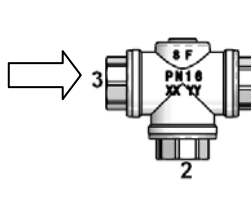
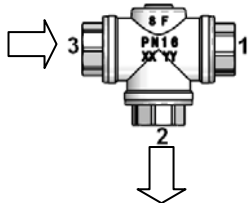
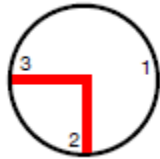
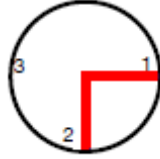
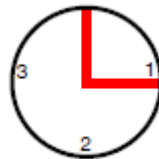

3 WAYS BRASS BALL VALVE PN16 THREADED

POSSIBLE POSITIONS DN 1/4" – 3/4" :

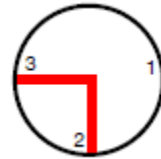
L port (only 2 consecutive positions are possible)

Position L1	Position L2	Position L3	Position L4	Position L5
				
				

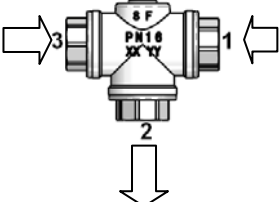
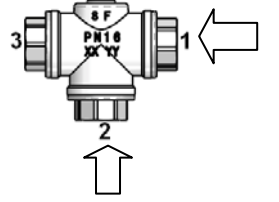
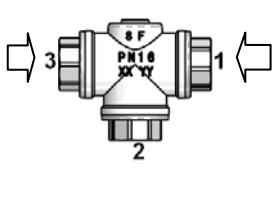
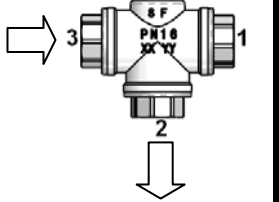
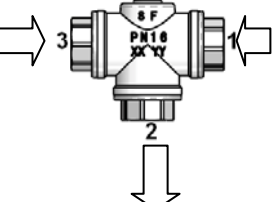
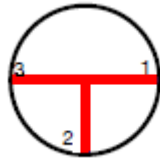
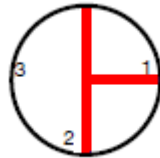
T port (only 2 consecutive positions are possible)

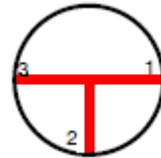
Position T1	Position T2	Position T3	Position T4	Position T5
				
				

3 WAYS BRASS BALL VALVE PN16 THREADED

POSSIBLE POSITIONS DN 1" – 2":

L port

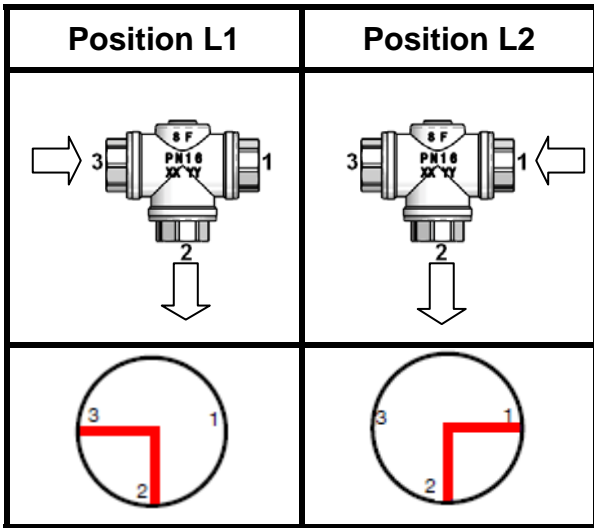

OR

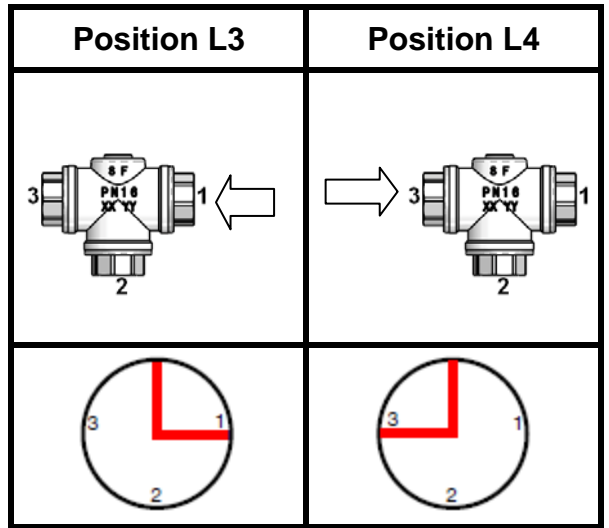

T port

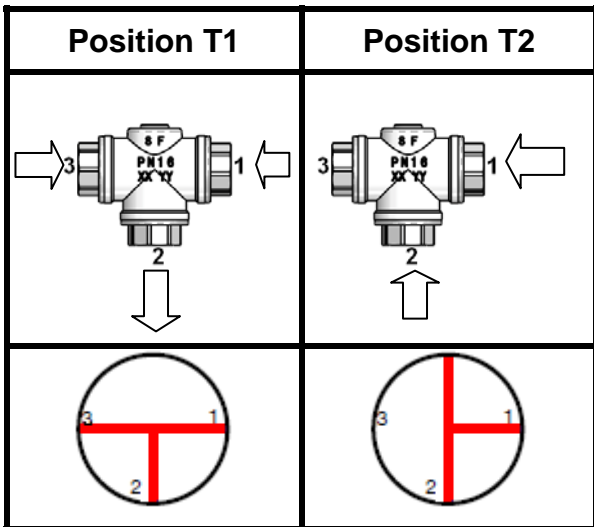

OR

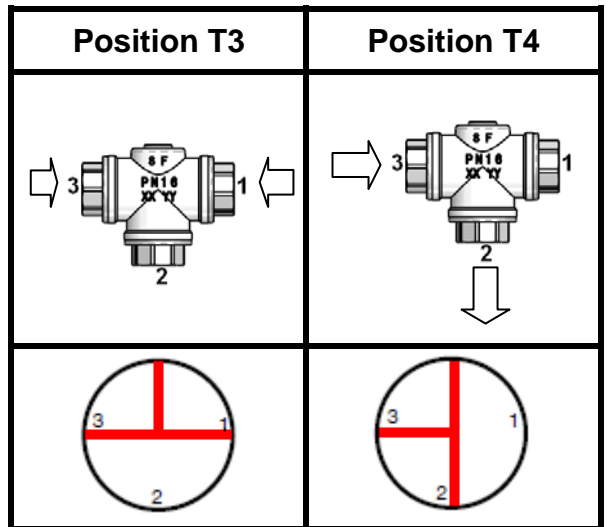

3 WAYS BRASS BALL VALVE PN16 THREADED

SIZE (in mm) :

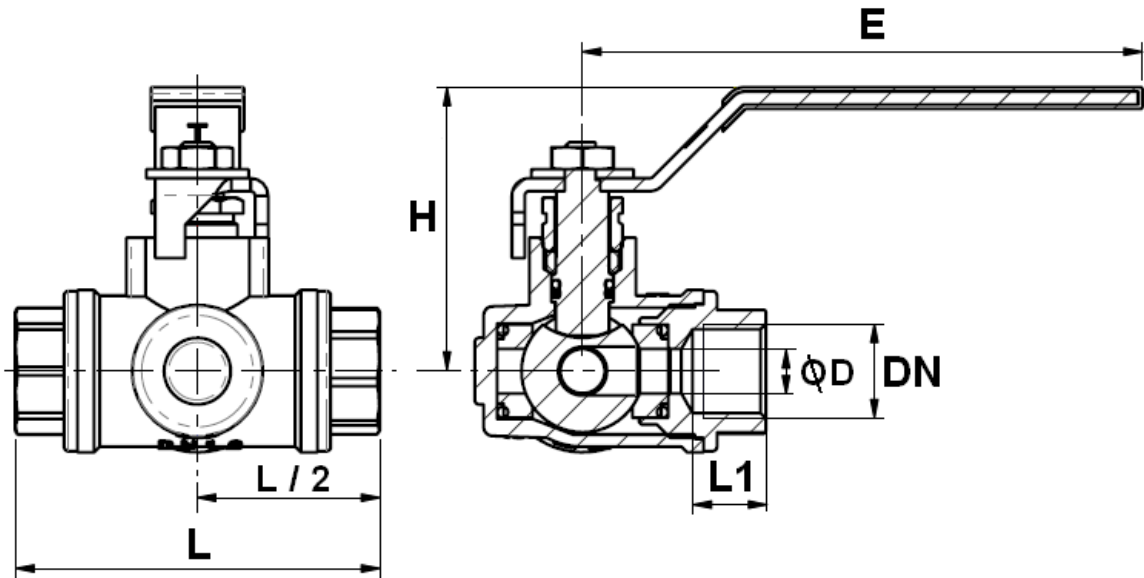

Ref.	DN	1/4"	3/8"	1/2"	3/4"	1"	1"1/4"	1"1/2"	2"
513 / 514	Ø D	10	10	10	15	20	25	32	40
	L	81	81	82	90.5	105	116	140	164
	L1	15	15	16.5	19	21	23	28	30
	E	125.5	125.5	125.5	125.5	161	161	220	220
	H	64	64	64	67	72	78.5	92	98
513	Weight (Kg)	0.688	0.657	0.661	0.873	1.443	1.954	3.666	5.314
514	Weight (Kg)	0.684	0.653	0.661	0.865	1.423	1.904	3.557	5.501

3 WAYS BRASS BALL VALVE PN16 THREADED

STANDARDS :

- Fabrication according to ISO 9001 : 2008
- DIRECTIVE 97/23/CE : Concerned by article 3, § 3
- Threaded female BSP cylindric

ADVICE : Our opinion and our advice are not guaranteed and SFERACO shall not be liable for the consequences of damages. The customer must check the right choice of the products with the real service conditions.

3 WAYS BRASS BALL VALVE PN16 THREADED

INSTALLATION INSTRUCTIONS

GENERAL GUIDELINES :

- Ensure that the valves to be used are appropriate for the conditions of the installation (type of fluid, pressure and temperature).
- Be sure to have enough valves to be able to isolate the sections of piping as well as the appropriate equipment for maintenance and repair.
- Ensure that the valves to be installed are of correct strength to be able to support the capacity of their usage.
- **Installation of all circuits should ensure that their function can be automatically tested on a regular basis (at least two times a year).**

INSTALLATION INSTRUCTIONS :

- **Before installing the valves, clean and remove any objects from the pipes** (in particular bits of sealing and metal) which could obstruct and block the valves.
- **Ensure that both connecting pipes either side of the valve (upstream and downstream) are aligned (if they're not, the valves may not work correctly).**
- **Make sure that the two sections of the pipe (upstream and downstream) match, the valve unit will not absorb any gaps. Any distortions in the pipes may affect the tightness of the connection, the working of the valve and can even cause a rupture.** To be sure, place the kit in position to ensure the assembling will work.
- Before starting the fitting, ensure that the threads and tapping are clean.
- **If sections of piping do not have their final support in place, they should be temporarily fixed. This is to avoid unnecessary strain on the valve.**
- The theoretical lengths given by ISO/R7 for the tapping are typically longer than required, the length of the thread should be limited, and **check that the end of the tube does not press right up to the head of the thread.**
- Position the pipe clips on both sides of the valve.
- If mounting on an air conditioning with PER tubing and hoses, it is necessary to support the tubes and hoses with the fixing to avoid strain on the valve.
- When screwing the valve, ensure that you only rotate on screwed side by the 6 ended side. Use an open ended spanner or an adjustable spanner and not a monkey wrench.
- **Never use a vice to tighten the fixings of the valve.**
- Do not over tighten the valve. Do not block with any extensions as it may cause a rupture or weakening of the casing.
- **In general, for all valves used in buildings and heating, do not tighten above a torque of 30 Nm.**

The advice and assembly instructions above do not conform to any guarantee.
The information is given in general. It states what must not and must be done.
It is provided to ensure the safety of the personnel and the reliability of the valves.
The instructions in bold must be followed.

Sferaco 90 rue du Ruisseau 38297 St Quentin Fallavier Tel: + 33 (0) 474.94.15.90 Fax: + 33 (0) 474.95.62.08 Internet: www.sferaco.fr E-mail: sferaco@sferaco.fr