

Applications

- Drinking and service water supply
- Irrigation and spray irrigation
- Lowering and maintaining ground water levels
- Pressure boosting
- Fountains
- Mining, offshore, tank farms
- Building services systems
- VDS sprinkler systems

Operating Data

Capacity	Q	up to 840 m ³ /h (233 l/s)
Head	H	up to 480 m
Temperature of fluid handled	t	up to +50 °C
Speed	n	≈ 2900 rpm
Supply voltage	U	up to 10,000 V

Design

Single- or multistage centrifugal pumps in pump shroud or in ring-section design. Radial or mixed flow hydraulic systems; reduced impeller diameters also available in some cases. The stage casings of radial pumps are connected by metal straps, those of mixed flow pumps by stud bolts. Suction casing fitted between pump and motor. Suction casing equipped with strainer to protect the pump from coarse particles in the fluid. Pumps with check valve or connection branch on option. Available with threaded or flanged end on option. Particularly suitable for vertical installation in narrow deep wells.

Pump Designation (Example)

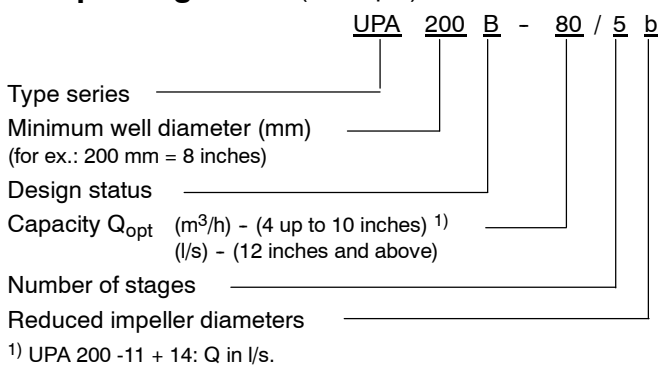

Motor Designation (Example)

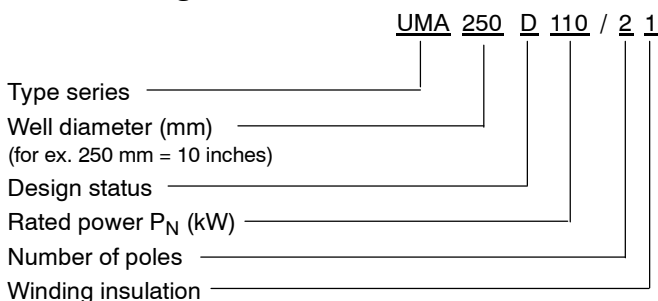

Certification

Quality management certified to ISO 9001

Submersible Borehole Pumps

S 100D, UPA 100C, UPA 150C, UPA 200,
UPA 200B, UPA 250C, UPA 300,
UPA 350, BSX - BSF, UPZ



Available automation products:

- Hyamaster (UPA 200 - UPA 350)
- hyatronic (UPA 200 - UPA 350)
- switch gear (S 100D - UPA 350)

Complete Range

The complete submersible borehole pump range comprises pump models for flow rates up to Q = 2500 m³/h (695 l/s) and heads up to H = 1500 m.

The submersible motor range covers sizes for power ratings up to P = 3500 kW and voltages up to U = 10,000 V for 50 and 60 Hz.

In addition, a special range is available which features submersible motors with a higher number of poles.

Product Information as per Regulation No. 547/2012 (for 4” and 6” Water Pumps) Implementing “Ecodesign” Directive 2009/125/EC

- Minimum efficiency index: see data sheet
- The benchmark for most efficient water pumps is MEI ≥ 0.70 .
- Year of construction: see data sheet
- Manufacturer’s name or trade mark, commercial registration number and place of manufacture: see data sheet or order documentation
- Product’s type and size identifier: see data sheet
- Hydraulic pump efficiency (%) with trimmed impeller: see data sheet
- Pump performance curves, including efficiency characteristics: see documented characteristic curve
- The efficiency of a pump with a trimmed impeller is usually lower than that of a pump with the full impeller diameter. The trimming of the impeller will adapt the pump to a fixed duty point, leading to reduced energy consumption. The minimum efficiency index (MEI) is based on the full impeller diameter.
- The operation of this water pump with variable duty points may be more efficient and economic when controlled, for example, by the use of a variable speed drive that matches the pump duty to the system.
- Information relevant for disassembly, recycling or disposal at end of life: see installation/operating manual
- Information on benchmark efficiency or benchmark efficiency graph for MEI = 0.7 (0.4) for the pump based on the model shown in the Figure are available at: <http://www.europump.org/efficiencycharts>

Contents	Page
Product Information as per Regulation No. 547/2012 (for 4” and 6” Water Pumps) Implementing “Ecodesign” Directive 2009/125/EC	2
The Submersible Borehole Pump Range	4
Operation with Soft Starters	5
Operation with Frequency Inverter	6
Typical Installation Positions	7
Submersible Borehole Pump Selection for Deep Wells	8
Request for Quotation (Form)	9
Head Losses in the Piping	10
Pump Sets 4 inches	11 + 23
Pump Sets 6 inches	33
Pump Sets 8 inches / 10 inches	57
Pump Sets 12 inches / 14 inches	77
Pump Sets 16 inches and above	91 + 95
Typical Tenders: 4 to 14 inches	99
Submersible Motors	104
Accessories	106
Flow Velocity “v” Past the Motor	116

What can you expect from the “Submersible Borehole Pumps Booklet”?

The information provided can help you make a

- quick
- first rough selection
- on your own

to find a suitable KSB submersible borehole pump for your application. We have kept the volume of the catalogue down to what we think is the absolute minimum. For the 4 to 14 inch range, you will find the following information on the pump selected:

- pump series, size and number of stages,
- motor series, size, power, amperage, and allowable temperature,
- starting method, supply voltage and type of installation,
- material variants and
- major dimensions and weights.

You may also complete, to the extent possible, the request for quotation on page 9.

You will then receive as soon as possible a detailed quotation and, if required, additional literature on KSB submersible borehole pumps from the nearest KSB sales branch.

Benefits at a Glance

- + Full range of products
- + High-tech equipment
- + Optimum material selection
- + Maximum efficiency
- + Functional reliability
- + Long service life
- + No maintenance
- + “Clean” technology
- + Customer focus

General

Information on fields of application, available models, type of installation, direction of rotation, coating, connection to power supply and speed control is provided in the detailed sections for the relevant type series.

The characteristic curves shown are for preliminary selection only. Exact selection data will be provided in our quotation.

Pump Efficiency

The characteristic curves for UPA 200/200B and larger pumps show pump efficiency for the maximum and optimum (reduced) impeller diameter (for ex. "c"). The efficiency of pumps with a low number of stages or considerably reduced impeller diameter (for ex. "d", "e") is lower than the value shown; it is given in the individual characteristic curves specifically prepared for the quotation.

Dry Running Protection

For use in wells with marked water level fluctuations or temporary low yield we strongly recommend installing dry running protection equipment ("Accessories").

Application Temperatures

The submersible borehole pumps are, as a standard, suitable for use in water with temperatures of up to $t = +30\text{ °C}$. An indispensable requirement for this is a flow velocity of $v = 0.2\text{ m/s}$ past the motor. This requirement is met, for example, when the pump is installed in a deep well above the well screen / filter, etc. With certain restrictions, some motor sizes may also be used in water with temperatures of up to $t = +50\text{ °C}$ and for operation without an adequate cooling flow of water past the motor, i.e. $v = 0\text{ m/s}$ (for example, when the unit is installed in a deep well below the screen / filter area or in a pump sump, etc.).

The details below provide data of adequate accuracy for the allowable temperature as a function of the type of installation, motor size and flow velocity v past the motor:

Vertical installation:

- DN 100:
 $t_{\text{allow}} = t_{\text{max}}^1$ irrespective of flow past the motor.
- UMA 150D/200D:
 $v = 0\text{ m/s} \dots \dots t_{\text{allow}} \approx t_{\text{max}}^1 - 5\text{ °C}$,
 $v \geq 0.2\text{ m/s} \dots \dots t_{\text{allow}} = t_{\text{max}}^1$,
 $v \geq 0.5\text{ m/s} \dots \dots t_{\text{allow}} \approx t_{\text{max}}^1 + 5\text{ °C}$.
- UMA 250D:
 $v = 0\text{ m/s} \dots \dots$ Please consult manufacturer,
 $v \geq 0.2\text{ m/s} \dots \dots t_{\text{allow}} = t_{\text{max}}^1$,
 $v \geq 0.5\text{ m/s} \dots \dots t_{\text{allow}} \approx t_{\text{max}}^1 + 5\text{ °C}$.

¹⁾ Values taken from tables on pages 15, 16 etc., 27, 28 etc..

Horizontal installation:

The principle is the same as for vertical installation.
Exception: Pumps with UMA 250D motors.

These units must always be equipped with a **flow inducer sleeve**. The flow inducer sleeve is not required, if the given pump is equipped with a motor having a 10 % higher power rating.

For all pump sets:

For a flow velocity of $v \geq 0.5\text{ m/s}$ and horizontal installation, check back with the manufacturer.

The Submersible Borehole Pump Range

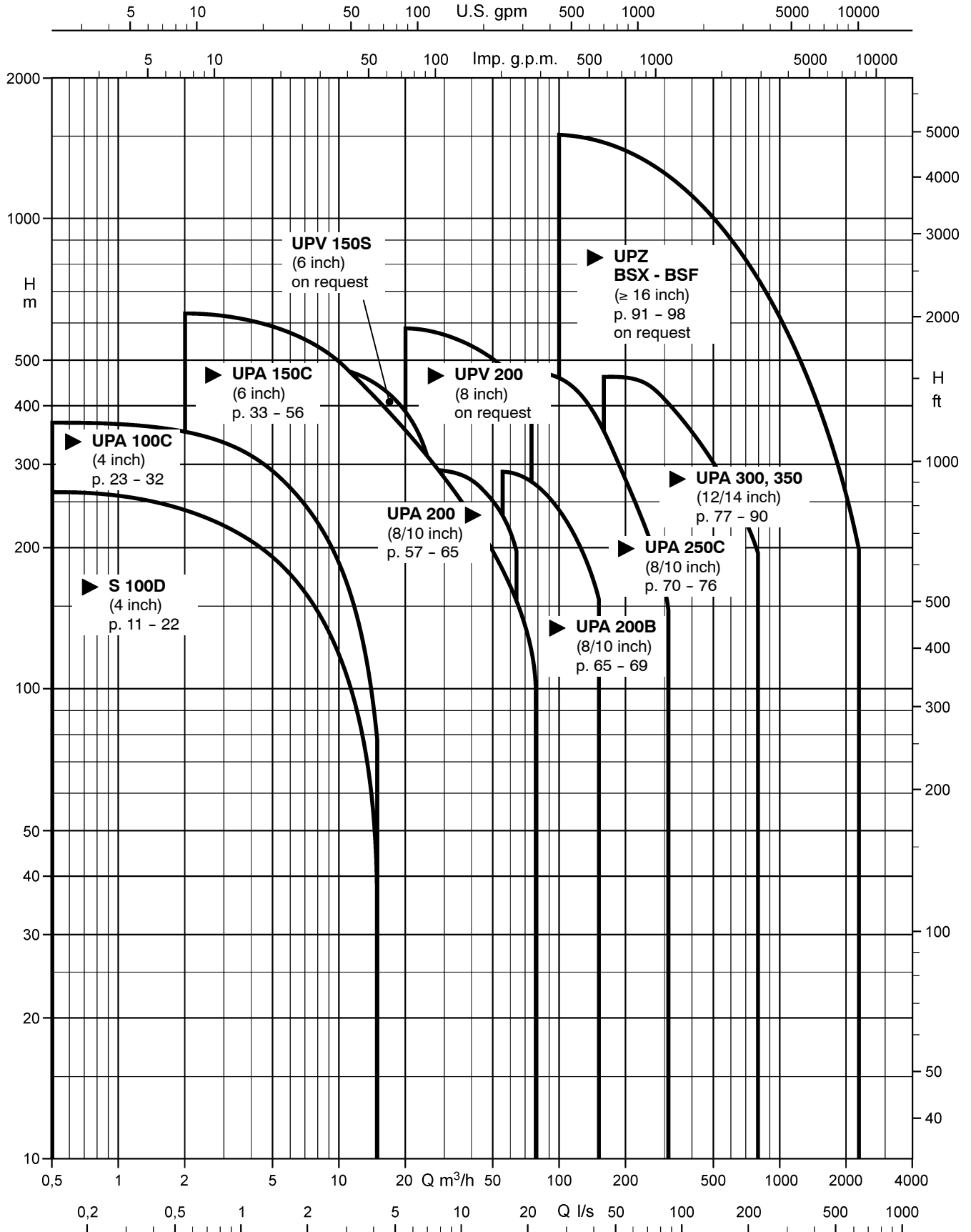

Operation of KSB submersible motor pumps with soft starters

Soft starter electronically reduce the incoming line voltage and, hence, the initial starting torque and starting current of electric motors. During run-up they gently ramp up the applied voltage to the motor.

In the case of submersible motors, the extremely slim design and consequential small moments of inertia result in special characteristics, which differ strongly from normal asynchronous motors.

Effects on submersible borehole pumps

- Starting current \Rightarrow approx. 40% to 65% of I_A required for direct-starting.
- Run-up time t_H increased to approx. 1s to 3s compared with approx. 0.2s to 0.5s for direct. starting.
- Starting torque M_A roughly 1/4 of the direct-starting torque.
- No current or torque peaks (I_A , M_A), as in star-delta switching arrangement.
- Hydraulic pressure surges (waterhammer) upon starting and stopping of the pump can be reduced, but not fully eliminated. Therefore, soft starters are not suitable for solving water hammer problems.

This would require the use of hydraulic control equipment or a frequency inverter. To prevent effects due to power failure, additional measures are required.

Note

Conspicuous noise or vibrations during run-up could well be an indication of incorrect settings on the soft starter. This might be due to exceeded ramp-up periods, incorrect operating mode (setting), activated special functions, etc.

Soft starter settings

Parameter / Function	Setting	Comments
Minimum starting voltage	40% of the motors' rated voltage	
Ramp time / acceleration (run-up) time	< 4s	Ramp time is not identical with the motor actual run-up time
Current limitation	I_A / I_N preset to approx. 3.5	Should only be altered with allowance for $t_H < 4s$
Deceleration (run-down) time / stop ramp	Deceleration time $t_A < 4s$	Better without a ramp.
Special functions, e.g.: - special "pump function" - kick-start / boost function - speed adjustment - Current controller - cos φ - / economy function - delayed starting	OFF	Do not use, as they tend to be troublesome, particularly in submersible borehole applications.

During operation the soft starter must be bridged (bypass). This helps to avoid losses at the machine and motor to secure proper permanent operation.

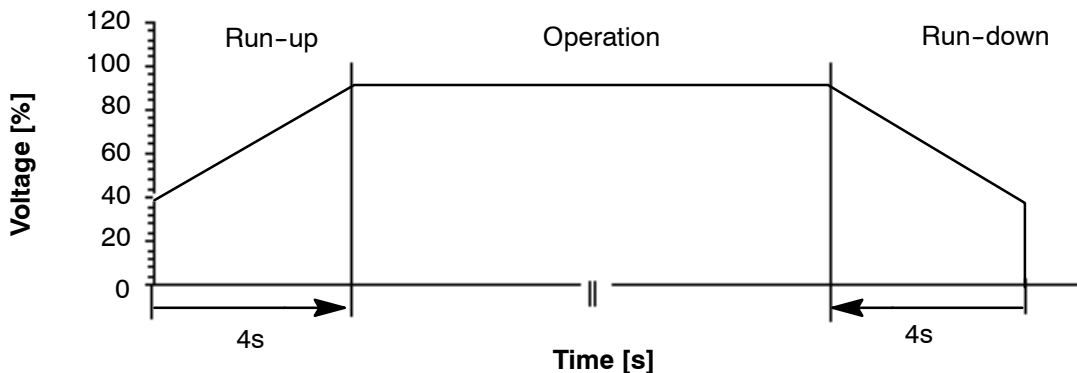

Pump Operation with Frequency Inverter

In principle, the motors of submersible borehole pumps can also be run on a frequency inverter. As submersible motors differ from conventional standardized motors in terms of bearings, moment of inertia, insulation, temperature increase, loss distribution and heat distribution, the following parameters must be observed:

- Maximum allowable acceleration time (start ramp)
- Maximum allowable deceleration time (stop ramp)
- Minimum frequency
- Maximum operating frequency
- Maximum permissible voltage increase velocity and peak voltages
- Control principle of frequency inverter

Maximum Allowable Acceleration Time (Start Ramp) and Deceleration Time (Stop Ramp)

The plain bearings of the submersible motor do not tolerate operation below the minimum frequency f_{min} (operation in mixed lubrication range).

For this reason, the acceleration period from standstill to minimum frequency f_{min} should not exceed 2s. The same applies to the deceleration period.

Minimum Frequency

Motor size	Minimum frequency f_{min} (Hz)	
	Vertical installation	Horizontal installation
DN 100	30	30
UMA 150D	20	30
UMA 200D		
UMA 250D		
UMA 300D /2		
UMA 300D /4	30	35

Maximum Operating Frequency

Frequency inverter operation above the nominal frequency (50Hz / 60Hz) of the pump unit must be avoided so as to prevent motor overload.

Maximum Permissible Voltage Increase Velocity and Peak Voltages

Excessive voltage increase velocities and excessive peak voltages will reduce the service life of the winding insulation. For this reason, the following limits must be adhered to:

- Maximum voltage increase velocity:
 $du/dt \leq 500 \text{ V}/\mu\text{s}$
- Maximum peak voltages to earth:
Low-voltage motors $\leq 1 \text{ kV}$: J1 insulation $\leq 600 \text{ V}$
J2 insulation $\leq 800 \text{ V}$

For motor sizes DN 100, the limit values for J1 insulation apply.

Note: Compliance with these limits can usually be assured by means of a sine filter or du/dt filter.

Control Principle of Frequency Inverter

The control principle of the frequency inverter must correspond to linear U/f curve control. If other control principles are employed, such as field-oriented inverters, inverters with DTC or NOF, the manufacturer of the frequency inverter must ensure that the special requirements of submersible motors (very small moment of inertia, electrical data) are taken into account.

Note: For details refer to "Design and Selection Information for Running Submersible Borehole Pumps on Frequency Inverters", Ref. No. 3400.0610-10.

Typical Installation Positions

a) Vertical Installation
(deep well, pump sump, etc.)

CAUTION:

The construction of the well head must meet the relevant regulations of the competent authorities! The unit must never be installed with its suction strainer exactly at the level of the well screen / filter!

Before installing the unit in narrow deep wells we recommend to check narrow boreholes for dimensional accuracy over their entire length, e.g. by inserting a pipe of the length and biggest outside diameter of the pump unit. Sharp bends or bottlenecks can make installation difficult or even impossible.

The unit is supported on the well head by supporting clamps (low-weight units and low submergence) or a supporting flange. The construction of the well head must meet the relevant regulations of the competent authority.

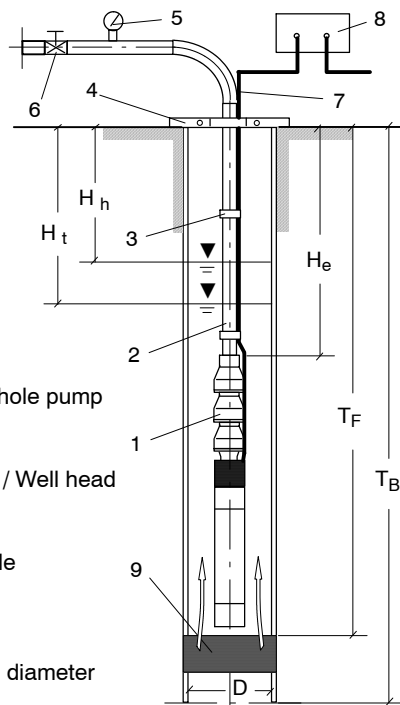

- 1 Submersible borehole pump
- 2 Riser pipe
- 3 Cable tie
- 4 Supporting flange / Well head
- 5 Pressure gauge
- 6 Shut-off valve
- 7 Power supply cable
- 8 Control box
- 9 Well screen / filter

- D = Inside well diameter
- T_B = Well depth
- T_F = Well screen / filter depth
- H_e = Installation depth
- H_h = Static water level
- H_t = Dynamic water level (Pumping water level)

Fig. 1 Vertical installation (in deep well, pump sump, etc.)

The suspension arrangement of the pump unit must be designed and dimensioned so that all static and dynamic forces can be absorbed and that the riser pipe cannot slip downwards. The supporting clamps or flanges must be fastened at the well head so that they cannot shift or lift off the well head.

The unit must never be installed with its suction strainer exactly at the level of the well screen / filter! Excessive flow in the area of the well screen / filter entails the risk of large amounts of entrained sand clogging the well screen / filter and causing excessive wear in the pump.

Pump units installed in a pump sump must generally be equipped with a cooling or suction shroud (fig. 2).

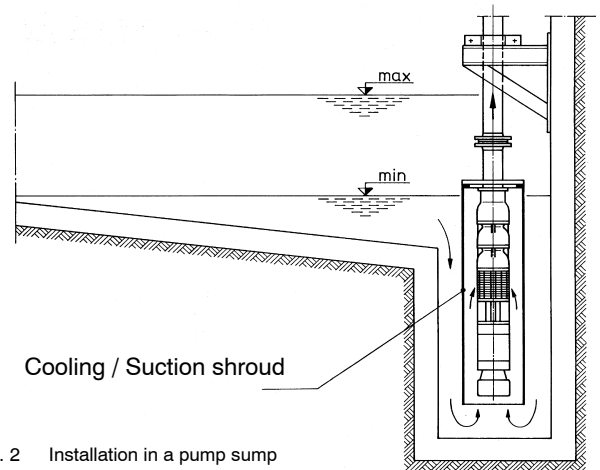

Fig. 2 Installation in a pump sump

b) Horizontal Installation
(in reservoirs, mine shafts, etc.)

CAUTION:

The instructions given in "a) Vertical installation" shall also apply by analogy to horizontal installation, when the pump unit is fitted on mounts (pedestals / supporting frame) supplied by us. If the pump and motor are supplied ready mounted on a supporting frame, on-site alignment of pump and motor will not be necessary. If this is not the case, the relevant installation / assembly drawing must be ordered, giving the following details:

- installation height (floor clearance),
- spacing of supports,
- submergence X

The ground / foundation must be level and of sufficient load-bearing capacity to accept the weight of the unit with supports.

Air intake from an inlet arranged above the water level is not permitted.

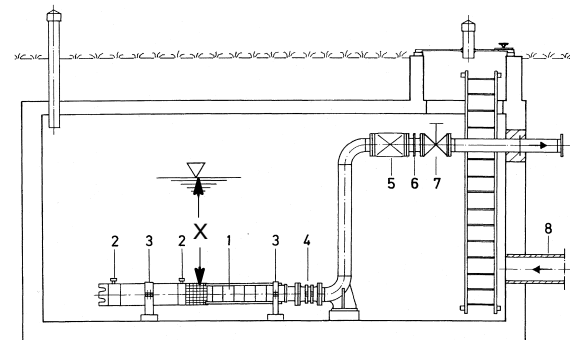

Fig. 3 Horizontal installation (in tanks, mine shafts etc.)

- 1 Submersible borehole pump
- 2 Water storage tanks (UMA 300D and 14D motors only)
- 3 Pedestal
- 4 Expansion joint
- 5 Check valve
(only if pump unit does not have its own check valve)
- 6 Dismantling joint
- 7 Shut-off valve
- 8 Intake

Submersible Borehole Pump Selection for Deep Wells

Pump Selection

The following data are required for a first rough selection of a submersible borehole pump:

- Capacity Q in m^3/h (l/s)
- Pressure at well head H_A in m
- Well diameter in inches or mm
- Temperature of fluid handled t_A in $^\circ\text{C}$
- Pump head H_P in m

While Q , H_A , D and t_A are usually specified by the customer, the head H_P to be developed by the pump needs to be calculated. There are two typical applications to be considered (see the drawing on the right):

1. Pumping into an open overhead tank

$$H_P = H_A + H_t + H_V + H_S \text{ [m]}$$

where ...

H_A = Required pressure at well head

H_t = Lowest water level (dynamic water level)

H_V = Head losses in the check valve (see characteristic curves for different stage numbers for UPA 150C and above).

H_S = Head losses in riser pipe up to well head (see page 10).

$$H_e = \text{Installation depth}$$

2. Pumping into a closed tank

$$H_P = H_A + H_t + H_V + H_S + p_{\ddot{u}} \text{ [m]}$$

where ...

$p_{\ddot{u}}$ = Gauge pressure (also air cushion) in a tank

Example

Given ...

$$Q_A = 120 \text{ m}^3/\text{h},$$

$$H_A = 95 \text{ m},$$

$$t_A = +15 \text{ }^\circ\text{C},$$

50 Hz, 400 V and d.o.l. starting,
well diameter $D = 250 \text{ mm}$ (10 inches).

Found ...

1. step:

pump type UPA 200B/250C

(for Q_A taken from selection chart on page 4)

2. step:

pump size UPA 200B - 130

(for Q_A taken from selection chart on page 50)

3. step:

pump set UPA 200B-130/6b + UMA 200D 45/21

(for $H_P = H_A + H_t + H_V + H_S = 95 + 4 + 0.75 + 0.26 = 100 \text{ m}$ with H_V taken from characteristic curves for different stage numbers on page 61).

Pump efficiency: $\eta_P = 80.5 \%$ (without check valve)

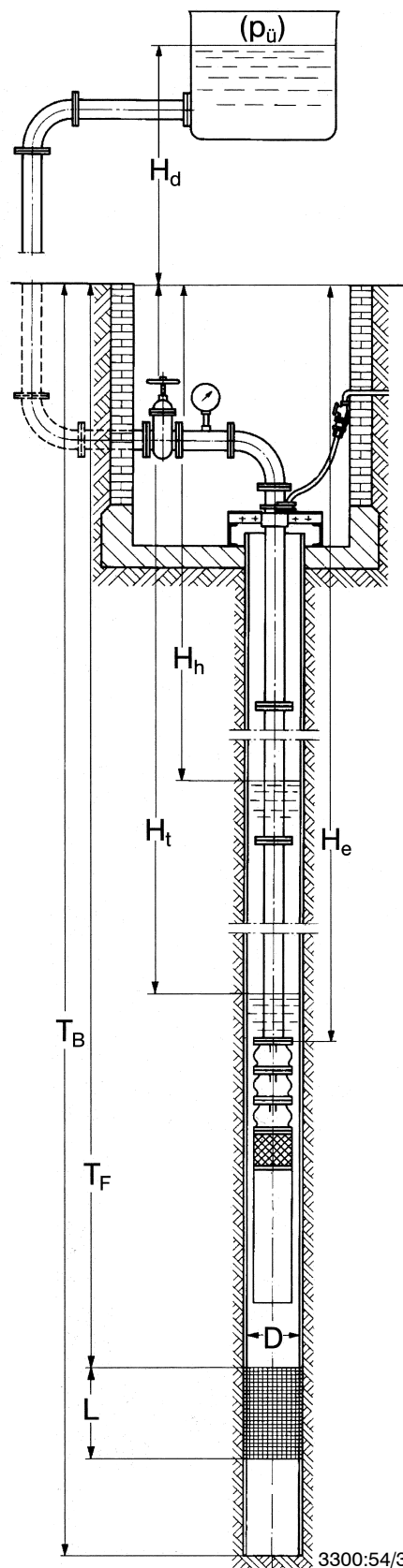
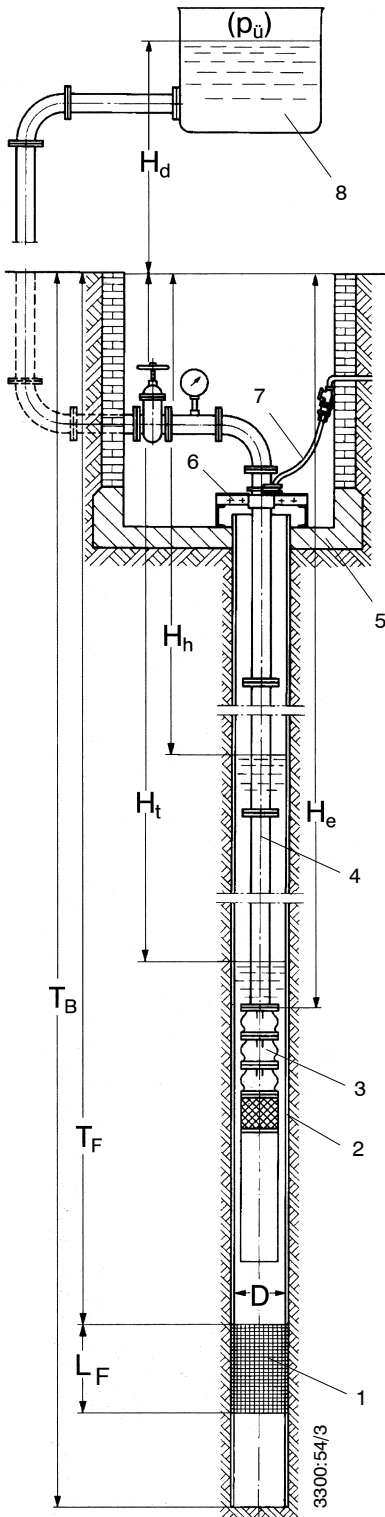

Figure:

Deep well with submersible borehole pump and overhead tank or closed tank at a pressure above atmospheric pressure of $p_{\ddot{u}}$.

Request for Quotation

We should like to test the efficiency and quality of your computer-aided quotation process. Please let us have a quotation based on the following data. (Fill in the required data and / or underline the relevant information, as far as available.)



- 1 Well screen / filter
- 2 Well casing
- 3 Submersible borehole pump
- 4 Riser
- 5 Well head housing
- 6 Well head
- 7 Power supply cable
- 8 Overhead tank

1. Water quality

Temperature °C
 Sand content g/m³
 Please attach water analysis, if available.

2. Type of system

Well / Mine shaft / Tank
 Free discharge above ground
 Discharge into an overhead tank
 Discharge into a pressure vessel

3. Deep well

Well depth (distance from ground level to well base):
 T_B = m

Inside diameter at submersible pump installation depth:
 D = mm (.... inches)

Well screen / filter:
 - Installation depth T_F = m
 - Length L_F = m

4. Capacity

Q = m³/h (..... l/s)

5. Total head

(including all friction losses)
 H = m
 If H is not known, please provide the following data:

a) Water level in well, measured from ground level:
 - Static water level: H_h = m
 - Dynamic water level: H_t = m (at capacity Q = m³/h)

b) Head above ground:
 Geodetic altitude up to the highest point of the pipeline or up to the highest water level in the overhead tank:
 H_d = m

Discharge head required at the end of the piping:

H = m (..... bar)

Cut-out pressure in the pressure vessel:
 p_Ü = bar

c) Piping outside well head housing:
 Overall length m

Nominal diameter mm
 Number of bends, valves and fittings:
 pcs

Inside diameter reduced by incrustation to: D = mm

6. Installation depth

Ground level to check valve / to connection branch:
 H_e = m

Caution: Do not install the submersible borehole pump at the level of the well screen / filter!

7. Power supply

Single- / three-phase alternating current.
 Mains voltage at well:
 U = V
 Frequency f = Hz

If voltage drops cannot be precluded:
 Minimum voltage ...
 U_{min} = V

8. Control box

Manual start-up / remote control / automatic start-up by way of float switch, pressure switch or dry running protection equipment.

Other types of switchgear:

9. Starting method

D.o.I. (without / with autotransformer or soft starter) or star-delta starting.

Head losses in the piping

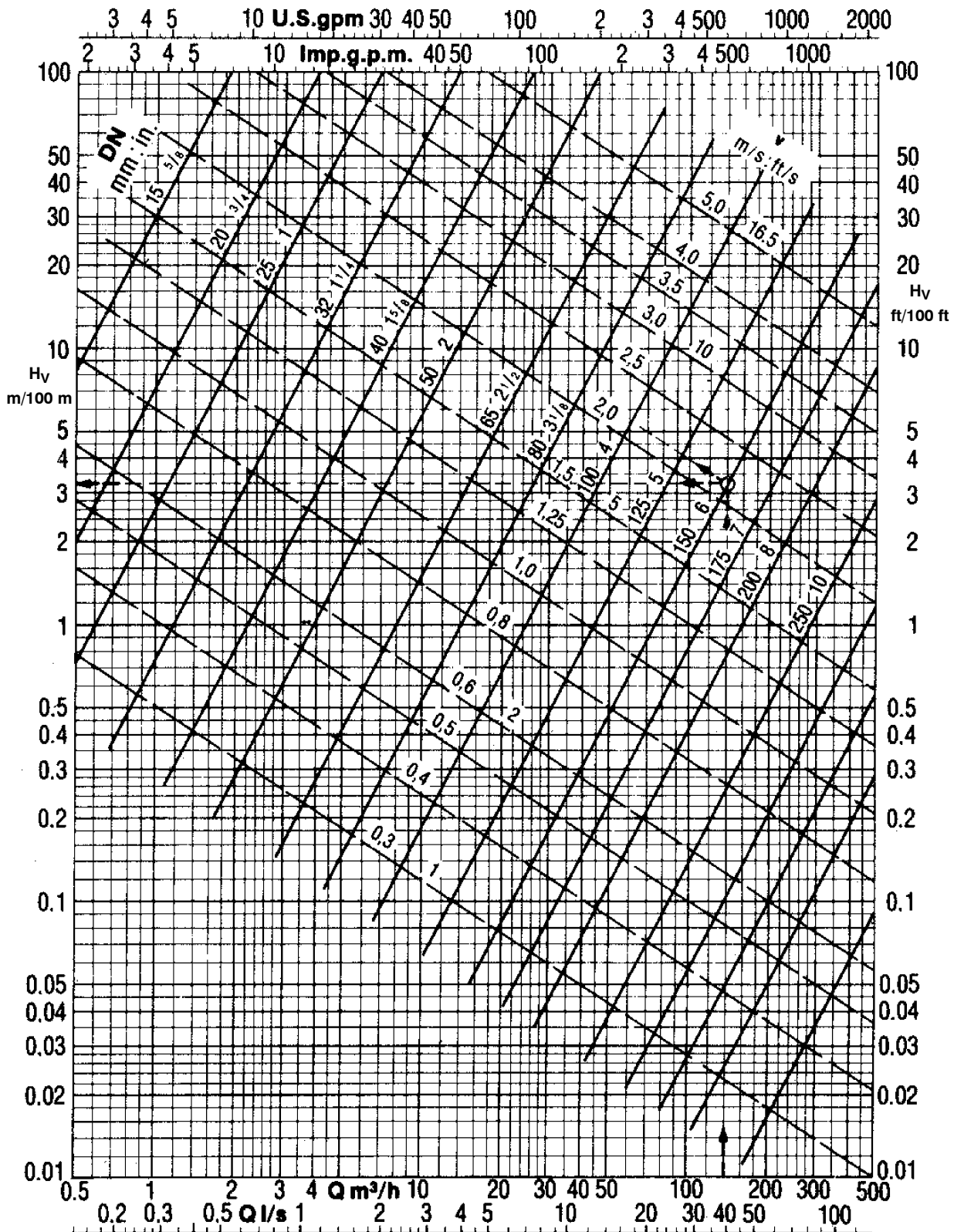

3300:103/3-2

The friction losses given in the above chart roughly apply to new cast iron pipes. For new rolled steel or plastic pipes, multiply the values by approx. 0.8. For old, slightly rusty cast iron pipes, multiply by approx. 1.25. In pipes with incrustations, friction losses may rise to 1.7 times the value given in the chart for the

diameter reduced by incrustations. For pipes subject to considerable incrustation, the friction losses can only be determined experimentally.

Example: $Q = 140 m^3/h$, new DN 150 cast iron pipe.

$H_v = 3.25 m$ per 100 m of pipe, $v = 2.2 m/sec$.

Applications

- Domestic and general water supply
- Irrigation and spray irrigation
- Lowering groundwater levels
- Fountains
- Pressure boosting
- Air-conditioning systems
- Fire protection
- Cooling water cycles

Operating Data

Capacity	Q up to 16 m ³ /h (4.4 l/s)
Head	H up to 300 m
Temperature of fluid handled	t up to +30 °C in continuous operation
Power	Pn up to 5.5 kW

Pump Type / Design

Pump:

Stainless steel and plastic multistage centrifugal pump.

- Additional bearing depending on the number of stages
- Pump sizes D1 and D2 with anti-blockage feature. This consists of a hexagonal polyurethane disc mounted to the back of the diffuser. A PE-HD ring fitted to the impeller front side sits close to the disc. The impeller hub is protected by a polyurethane ring. This design improves the starting torque of low-capacity pumps and has the effect that solid particles such as sand are propelled outside instead of clogging the pump.

Motor:

Submersible canned motor (Franklin), NEMA standard, 50 Hz

- For single-phase alternating current (type PSC) or three-phase current
- With short cable
- Connection to power supply mains by means of cable connector (accessories)
- D.o.l. starting, start-up frequency up to 20/h
- Type of enclosure IP 68
- Thermal class B

Designation

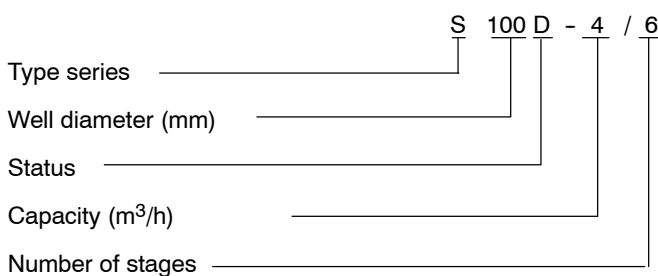

Recommended Accessories

UPA Control: Control box for motor and dry running protection by immersion electrodes.

Automatic control unit: in conjunction with the Controlmatic E or Cervomatic EDP control and monitoring units, which protect the pump against dry running, if the water level falls, S 100D can be used for automatic water supply

Certification

Quality management certified to ISO 9001

Submersible Borehole Pumps for Well Diameters of 100 mm (4 inch)



Available automation products:

- Automatic control unit

Product Features

- Pumps sizes D1 and D2 with anti-blockage feature
- Rust-proof
- Suitable for installation in narrow deep wells
- High efficiency
- Hermetically sealed motor
- Motor designed for maximum pump output
- Low noise level
- For vertical, angled or horizontal installation

Selection Chart (Ranges on Offer)

$n \approx 2900$ rpm

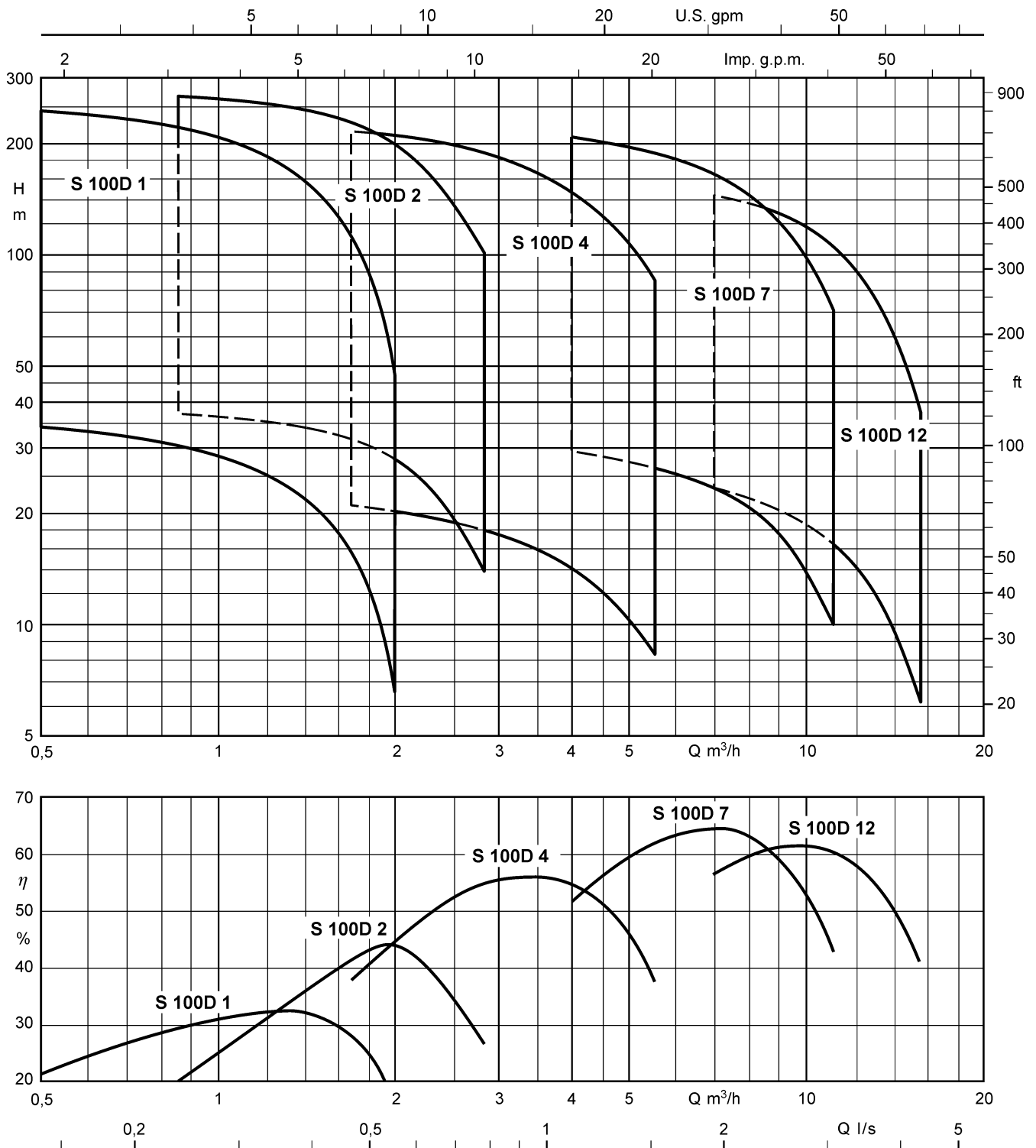

Note:

Up to a motor rating of $P_N = 2.2$ kW, all pump sizes can be supplied with either single-phase a.c. or three-phase current motors.

Materials

Component	C1
Pump ...	
Outer pump casing/ Suction casing / Valve housing	CrNi steel (1.4301)
Stage casing	CrNi steel (1.4301)
Stage casing (diffuser) / Impeller	glass fibre reinforced Noryl (PPO GF20V)
Shaft	Cr-steel (1.4021)
Bearing bush	Nitril NBR 80
Screws, bolts and nuts	CrNiMo-steel (A4-70)
Motor ...	
Shaft	CrNi steel (1.4305)
Bearing carrier	CrNi steel (1.4301)
Stator case	CrNi steel (1.4301)

Bearings / Lubrication

Plain bearings, lubricated by the fluid pumped or by the motor fill liquid. Depending on the number of stages, an additional intermediate bearing is provided in the pump.

The axial thrust is balanced by a thrust bearing in the motor. The hydraulic thrust is balanced by the pump's counter thrust bearing.

Direction of Rotation of the Pump

Clockwise rotation (viewed at the drive shaft end).

Pump End (Discharge Nozzle)

S 100D - 1, 2, 4 + 7: Internal thread G 1 1/4" (DN 32).
S 100D - 12: Internal thread G 2" (DN 50).

Installation

Vertical and, depending on the number of stages, also angled and horizontal installation.

Drive

Type canned motor in squirrel-cage design, 2 poles
 Connection NEMA standard
 Type of enclosure IP 68
 Frequency 50 Hz
 Type of current single-phase a.c. (1 ~) or three-phase (3 ~)
 Rated voltage U 220 ... 230 V (1~) and 380 ... 400 V (3~)
 Rated power P_N up to 2.2 kW for 1~ and up to 5.5 kW for 3~
 Voltage fluctuation up to ± 5 % acc. to VDE
 Frequency of starts up to 20/h
 Min. delay before restarting . 3 min

A starter for **single-phase a.c. motors** in PSC design (with integrated run capacitor and motor protection) is included in the scope of supply.

Connection to Power Supply

All DN 100 motors are factory-equipped as follows:
 1 x 1.5 m flat cable, quality 4 x 1.5 mm² (3 phases + 1 earth conductor).
 Exception: DN 100 motors with a rating of 5.5 kW, 3~, are equipped as follows: 2.5 m cable, quality 4 x 1.5 mm².

Connection of extension cable (any length) by means of a cable connector

Connected at the factory by means of a **standard cable connector (non-separable, shrink tube)**
 Ident. No. 40 980 708
 For cable quality 4 x 1.5 mm² or 4 x 2.5 mm²
 Ident. No. 39 020 536
 For cable quality 4 x 4 mm²

Connected at the factory with **Franklin cable connector (separable, sealing compound)**
 Ident. No. 90 049 385
 For cable quality 4 x 1.5 mm² up to 4 x 2.5 mm²

Starting Mode

Only **direct on line**.

Temperatures

The **S 100D** submersible borehole pump is designed for use in water with temperatures of up to t = + 30 °C.

Variants Available on Request

- Higher fluid temperatures
- Higher voltages up to 500 V
- Other frequencies

Design Features (Pump sizes D1 - D2)

Easy to commission and service

- Vent valve for operation with automatic control units such as Controlmatic E or Cervomatic EDP
- Easy to install thanks to plug-type connection of power cable of Franklin submersible motor
- The cable guard is easy to fit and remove.

High-duty impellers

- Made of glass fibre-reinforced Noryl, highly abrasion- and corrosion-resistant.
- With integrated keys for easy assembly.

Highly corrosion-resistant

- Suction casing, check valve housing and outer casing made of stainless steel
- Hydraulic system made of glass fibre reinforced Noryl

High operating reliability and long service life

- Maintenance-free and wear-protected pump bearings
- Special guide feature prevents jamming or tilting of the check valve
- Cable guard protects cables from damage.

Stainless steel cable guard

- Easy assembly and dismantling.
- Protects the power supply cable against damage during installation and dismantling.

Stainless steel stage casing without return vanes

- High pressure resistance.
- Easy assembly and dismantling.

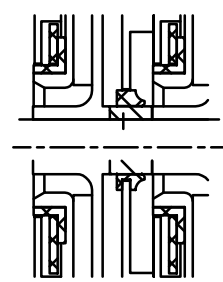
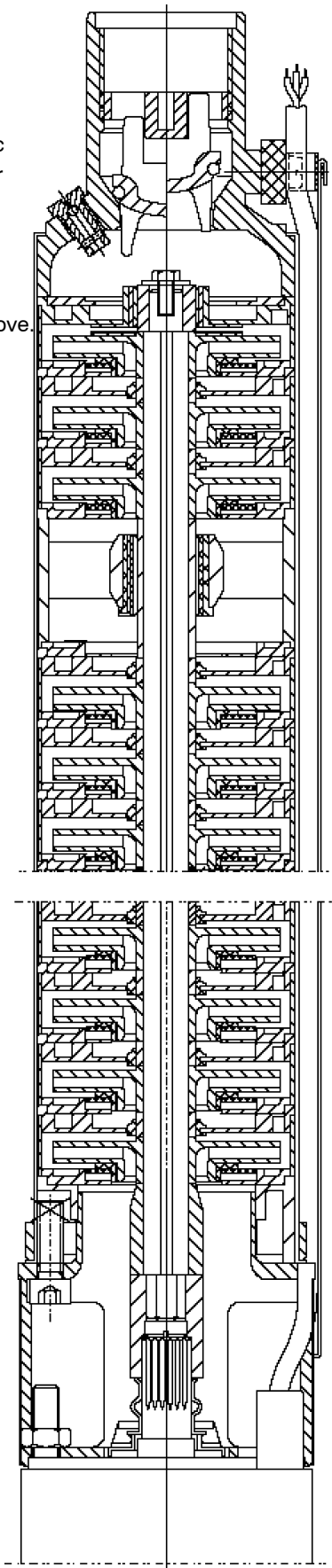

S 100D - 1 ...

for well diameters of 100 mm (4 inch)

Pumps with submersible motors for ...

- Temperature of fluid handled **up to + 30 °C**
- Current / Operating voltage **1~/230 V**
..... or **3~/400 V**
- Starting **direct**

Pump unit S 100D	Rated power (motor) P _N kW	Current intensity for ...		Installation ²⁾	Operation with control unit ³⁾
		1~ 230 V I _N ¹⁾ A	3~ 400 V I _N A		
1 / 7	0.37	3.4	1.3	v + h	x
1 / 9	0.37	3.4	1.3	v + h	x
1 / 12	0.55	3.4	1.3	v + h	x
1 / 14	0.55	4.3	1.7	v + h	x
1 / 16	0.55	4.3	1.7	v + h	x ³⁾
1 / 20	0.75	4.3	1.7	v + h	x ³⁾
1 / 25	1.10	5.7	2.2	v	x ³⁾
1 / 30	1.10	5.7	2.2	v	x ³⁾
1 / 35	1.50	8.6	3.2	v	x ³⁾
1 / 40	1.50	8.6	3.2	v	x ³⁾
1 / 50	2.20	10.6	4.0	v	x ³⁾⁴⁾

1) Capacitor run motors (PSC motors) with starter.
 2) v = vertical and h = inclined / horizontal.
 3) Always check and make sure that the operating pressure of Controlmatic / Cervomatic units is not exceeded.
 4) 3~ only

Note : Use a cooling shroud for horizontal installation.

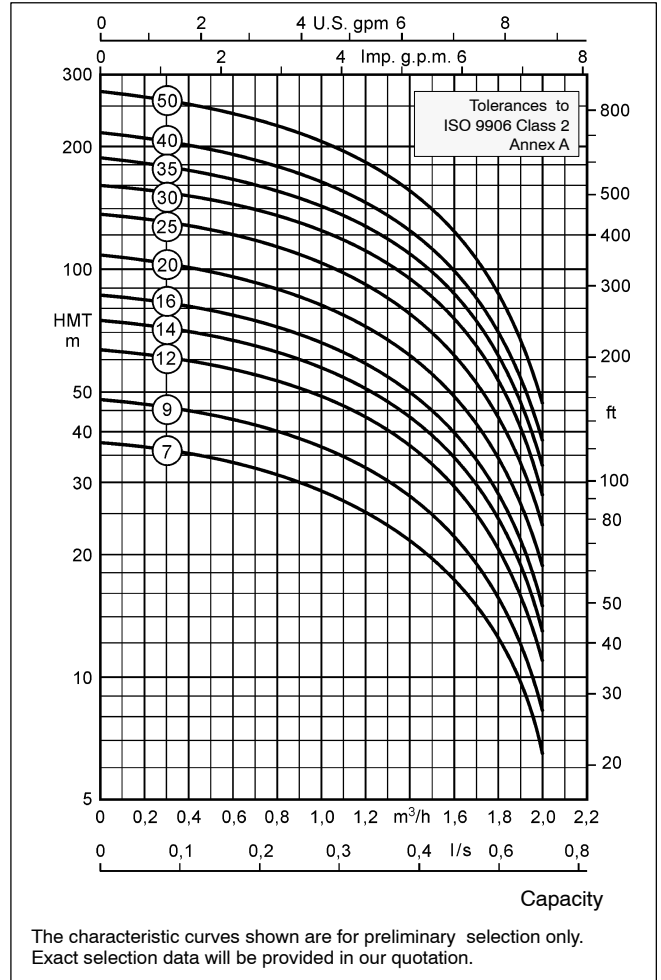

Dimensions / Weights / Ident. Numbers / Horizontal Installation

Pump unit S 100D	1~/ 230 V				3~/ 400 V				C
	L _A ≈ mm	m _A ≈ kg	Ident No.	A ≈ mm	L _A ≈ mm	m _A ≈ kg	Ident No.	A ≈ mm	
1 / 7	575	11.5	39 022 528	371	555	10.7	39 022 565	362	G 1 1/4"
1 / 9	625	11.7	39 022 529	425	605	10.9	39 022 566	416	
1 / 12	720	13.4	39 022 530	508	700	12.2	39 022 567	492	
1 / 14	795	13.6	39 022 531	552	755	12.4	39 022 568	537	
1 / 16	810	13.8	39 022 532	597	780	12.6	39 022 569	582	
1 / 20	925	14.3	39 022 533	687	870	13.1	39 022 570	672	
1 / 25	1100	16.3	39 022 534	----	1045	14.9	39 022 571	----	
1 / 30	1210	16.8	39 022 535	----	1150	15.4	39 022 572	----	
1 / 35	1395	20.0	39 022 536	----	1310	17.4	39 022 573	----	
1 / 40	1505	20.6	39 022 537	----	1450	18.0	39 022 574	----	
1 / 50	1805	22.7	39 022 538	----	1705	20.3	39 022 575	----	

For information on cooling shroud refer to page 20.

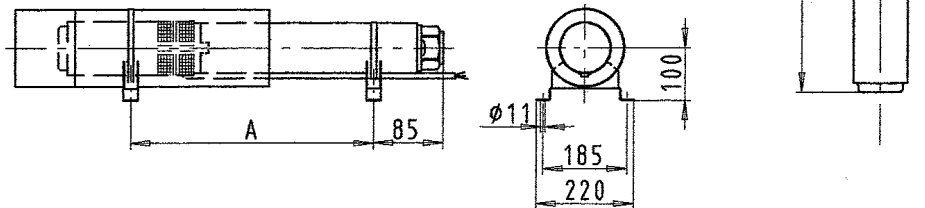

Accessories: UPA Control for dry running protection using 1 or 3 immersion electrodes, see page 21.

S 100D - 2 ...

for well diameters of 100 mm (4 inch)

Pumps with submersible motors for ...

- Temperature of fluid handled up to + 30 °C
- Current / Operation voltage 1~/230 V
- or. 3~/400 V
- Starting direct

Pump unit S 100D	Rated power (motor) P _N kW	Current intensity for ...		Installation ²⁾	Operation with control unit ³⁾
		1~ 230 V I _N ¹⁾ A	3~ 400 V I _N A		
2 / 7	0.37	3.4	1.3	v + h	x
2 / 11	0.55	4.3	1.7	v + h	x
2 / 15	0.75	5.6	2.2	v + h	x
2 / 18	1.1	8.6	3.2	v + h	x ³⁾
2 / 20	1.1	8.6	3.2	v + h	x ³⁾
2 / 22	1.1	8.6	3.2	v + h	x ³⁾
2 / 27	1.5	10.6	4.0	v + h	x ³⁾
2 / 30	1.5	10.6	4.0	v	x ³⁾
2 / 33	2.2	15.5	5.9	v	x ³⁾
2 / 38	2.2	15.5	5.9	v	x ³⁾
2 / 44	2.2	15.5	5.9	v	x ³⁾
2 / 50	3.0	-	7.8	v	x ³⁾⁴⁾

1) Capacitor run motors (PSC motors) with starter.
 2) v = vertical and h = inclined / horizontal.
 3) Always check and make sure that the operating pressure of Controlmatic / Cervomatic units is not exceeded.
 4) 3~ only

Note : Use a cooling shroud for horizontal installation.

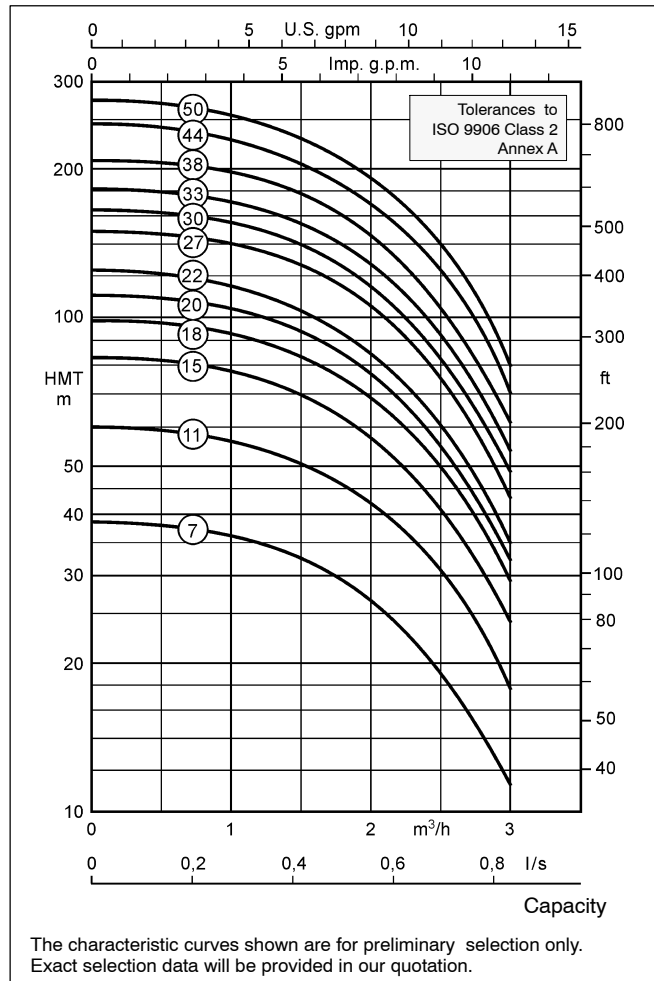

Dimensions / Weights / Ident. Numbers / Horizontal Installation

Pump unit S 100D	1~/ 230 V				3~/ 400 V				C
	L _A ≈ mm	m _A ≈ kg	Ident No.	A ≈ mm	L _A ≈ mm	m _A ≈ kg	Ident No.	A ≈ mm	
2 / 7	570	11.3	39 022 539	371	550	10.5	39 022 576	362	G 1 1/4"
2 / 11	695	13.0	39 022 540	484	665	11.8	39 022 577	470	
2 / 15	815	14.8	39 022 541	589	790	13.4	39 022 578	574	
2 / 18	940	17.7	39 022 542	684	880	15.1	39 022 579	655	
2 / 20	985	17.8	39 022 543	729	925	15.2	39 022 580	701	
2 / 22	1030	18.0	39 022 544	775	970	15.4	39 022 581	746	
2 / 27	1175	19.5	39 022 545	901	1120	17.1	39 022 582	873	
2 / 30	1235	19.9	39 022 546	----	1180	17.5	39 022 583	----	
2 / 33	1425	23.6	39 022 547	----	1325	19.0	39 022 584	----	
2 / 38	1535	24.1	39 022 548	----	1435	19.5	39 022 585	----	
2 / 44	1670	24.6	39 022 549	----	1570	20.0	39 022 586	----	
2 / 50	-----	-----	-----	----	1770	23.6	39 022 587	----	

For information on cooling shroud refer to page 20.

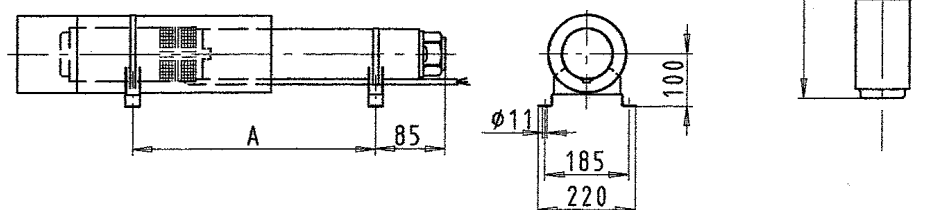

Accessories: UPA Control for dry running protection using 1 or 3 immersion electrodes, see page 21.

S 100D - 4 ...

for well diameters of 100 mm (4 inch)

Pumps with submersible motors for ...

- Temperature of fluid handled **up to + 30 °C**
- Current / Operating voltage **1~/230 V**
..... or **3~/400 V**
- Starting **direct**

Pump unit S 100D	Rated power (motor) P _N kW	Current intensity for ...		Instal- lation 2)	Opera- tion with control unit 3)
		1~ 230 V I _N ¹⁾ A	3~ 400 V I _N A		
4 / 3	0.37	3.4	1.3	v + h	x
4 / 6	0.55	4.3	1.7	v + h	x
4 / 8	0.75	5.7	2.2	v + h	x
4 / 11	1.10	8.6	3.2	v + h	x
4 / 16	1.50	10.6	4.0	v + h	x ³⁾⁴⁾
4 / 21	2.20	15.5	5.9	v + h	x ³⁾⁴⁾
4 / 24	2.20	15.5	5.9	v	x ³⁾⁴⁾
4 / 33	3.00	---	7.8	v	x ³⁾⁴⁾
4 / 40	3.70	---	9.1	v	x ³⁾⁴⁾

- 1) Capacitor run motors (PSC motors) with starter.
- 2) v = vertical and h = inclined / horizontal.
- 3) Always check and make sure that the operating pressure of Controlmatic / Cervomatic units is not exceeded.
- 4) 3~ only

Note : Use a cooling shroud for horizontal installation.

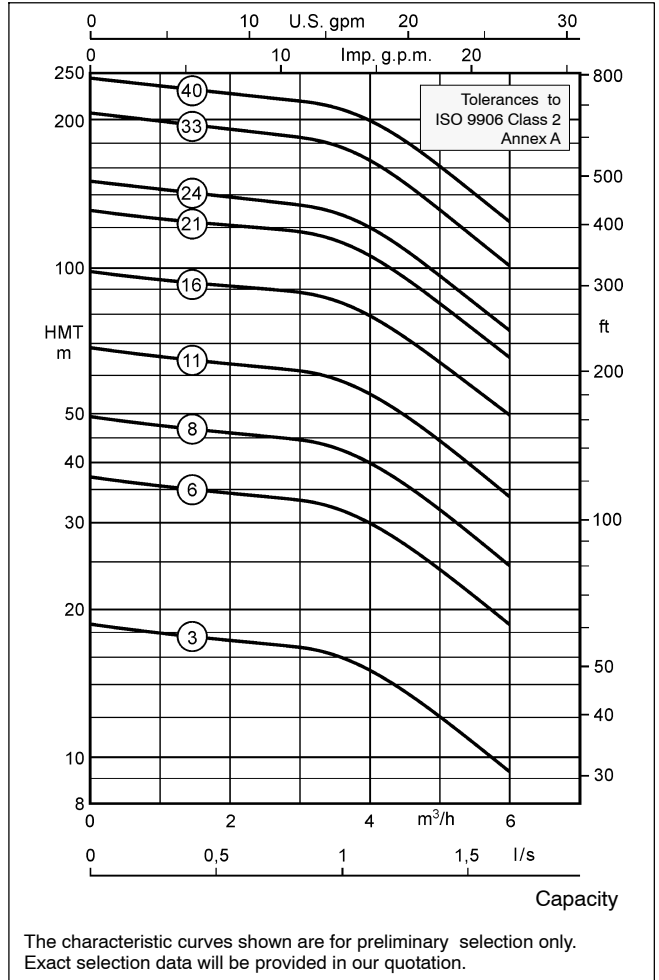

The characteristic curves shown are for preliminary selection only. Exact selection data will be provided in our quotation.

Dimensions / Weights / Ident. Numbers / Horizontal Installation

Pump unit S 100D	1~ / 230 V				3~ / 400 V				C
	L _A ≈ mm	m _A ≈ kg	Ident No.	A ≈ mm	L _A ≈ mm	m _A ≈ kg	Ident No.	A ≈ mm	
4 / 3	505	11.5	39 022 550	333	485	10.7	39 022 588	324	G 1 1/4"
4 / 6	610	13.4	39 022 551	399	580	12.2	39 022 589	384	
4 / 8	690	15.1	39 022 552	489	665	13.7	39 022 590	475	
4 / 11	820	18.2	39 022 553	594	760	15.6	39 022 591	566	
4 / 16	975	20.1	39 022 554	734	920	17.7	39 022 592	706	
4 / 21	1180	24.8	39 022 555	900	1080	20.2	39 022 593	847	
4 / 24	1255	25.3	39 022 556	---	1155	20.7	39 022 594	---	
4 / 33	---	---	---	---	1595	25.5	39 022 595	---	
4 / 40	---	---	---	---	1805	33.0	39 022 596	---	

For information on cooling shroud refer to page 20.

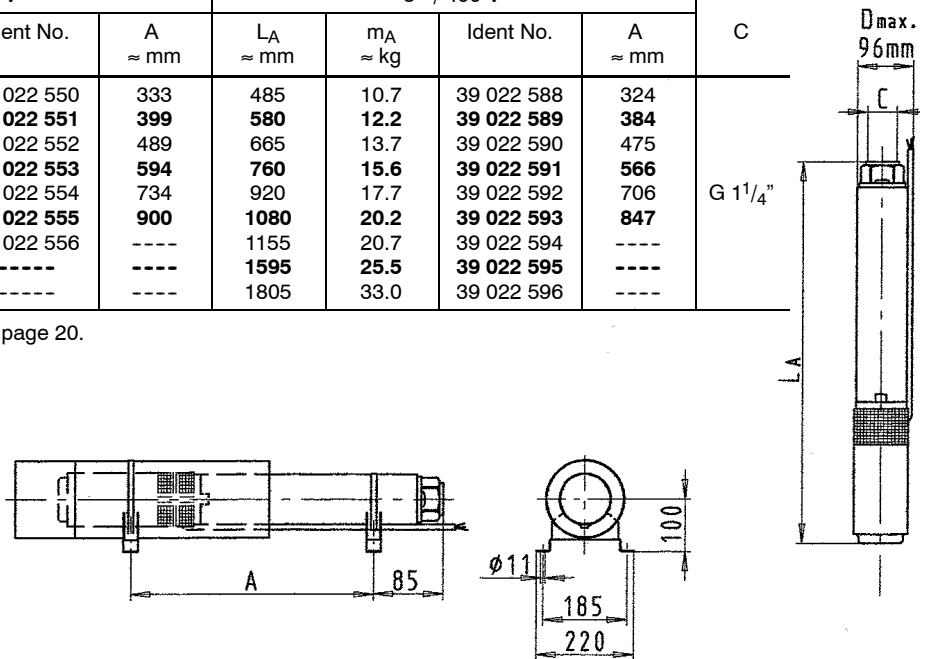

Accessories: UPA Control for dry running protection using 1 or 3 immersion electrodes, see page 21.

S 100D - 7 ...

for well diameters of 100 mm (4 inch)

Pumps with submersible motors for ...

- Temperature of fluid handled up to + 30 °C
- Current / Operating voltage 1~/230 V
..... or 3~/400 V
- Starting direct

Pump unit S 100D	Rated power (motor) P _N kW	Current intensity for ...		Installation ²⁾	Operation with control unit ³⁾
		1~ 230 V I _N ¹⁾ A	3~ 400 V I _N A		
7 / 4	0.75	5.7	2.2	v + h	x
7 / 6	1.10	8.6	3.2	v + h	x
7 / 8	1.50	10.6	4.0	v + h	x ⁴⁾
7 / 11	2.20	15.5	5.9	v + h	x ⁴⁾
7 / 13	2.20	15.5	5.9	v + h	x ⁴⁾
7 / 18	3.00	---	7.8	v + h	x ³⁾⁴⁾
7 / 23	3.70	---	9.1	v	x ³⁾⁴⁾
7 / 28	5.50	---	13.7	v	x ³⁾⁴⁾
7 / 33	5.50	---	13.7	v	x ³⁾⁴⁾

- 1) Capacitor run motors (PSC motors) with starter.
- 2) v = vertical and h = inclined / horizontal.
- 3) Always check and make sure that the operating pressure of Controlmatic / Cervomatic units is not exceeded.
- 4) 3~ only

Note : Use a cooling shroud for horizontal installation.

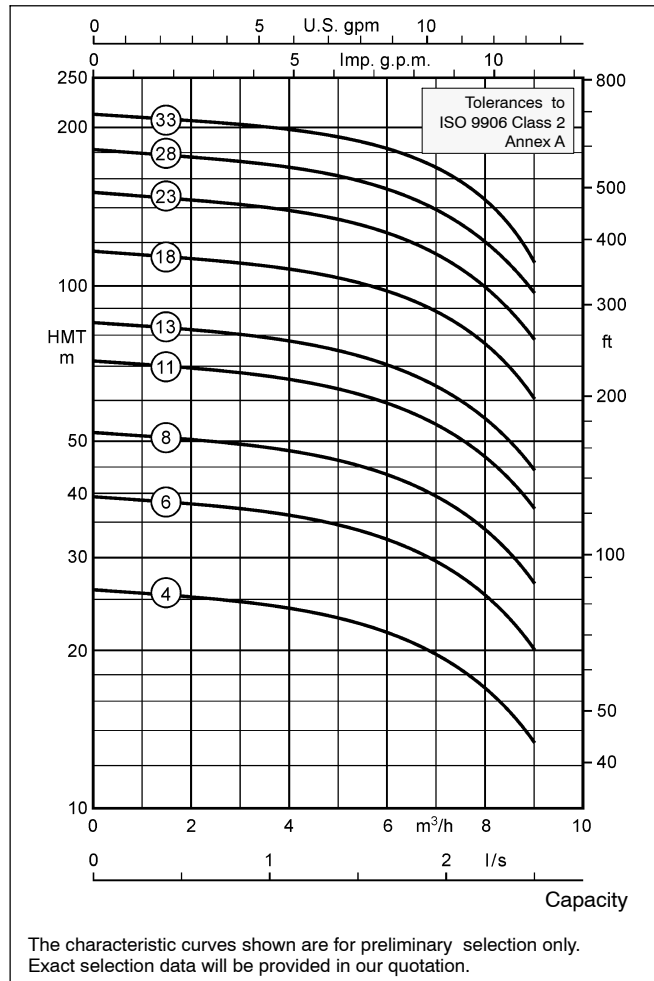

Dimensions / Weights / Ident. Numbers / Horizontal Installation

Pump unit S 100D	1~ / 230 V				3~ / 400 V				C
	L _A ≈ mm	m _A ≈ kg	Ident No.	A ≈ mm	L _A ≈ mm	m _A ≈ kg	Ident No.	A ≈ mm	
7 / 4	611	14.6	39 022 557	421	586	13.2	39 022 597	407	G 1 1/4"
7 / 6	736	17.7	39 022 558	517	676	15.1	39 022 598	489	
7 / 8	831	19.1	39 022 559	599	776	16.7	39 022 599	571	
7 / 11	1011	23.1	39 022 560	740	911	18.5	39 022 600	687	
7 / 13	1076	23.6	39 022 561	808	976	19.0	39 022 601	755	
7 / 18	----	----	----	----	1211	23.1	39 022 602	958	
7 / 23	----	----	----	----	1516	30.8	39 022 603	----	
7 / 28	----	----	----	----	1881	38.3	39 022 604	----	
7 / 33	----	----	----	----	2051	39.4	39 022 605	----	

For information on cooling shroud refer to page 20.

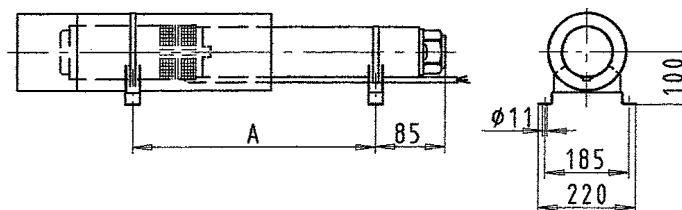
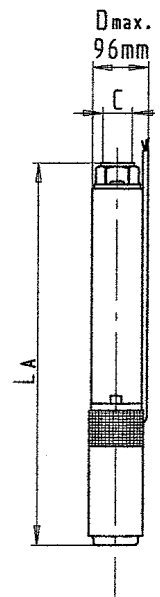

Accessories: UPA Control for dry running protection using 1 or 3 immersion electrodes, see page 21.

S 100D - 12 ...

for well diameters for 100 mm (4 inch)

Pumps with submersible motors for ...

- Temperature of fluid handled **up to + 30 °C**
- Current / Operation voltage **1~/230 V**
..... or **3~/400 V**
- Starting **direct**

Pump unit S 100D	Rated power (motor) P_N kW	Current intensity for ...		Installation ²⁾	Operation with control unit ³⁾
		1~ 230 V I_N¹⁾ A	3~ 400 V I_N A		
12 / 4	1.1	8.6	3.2	v + h	x
12 / 6	1.5	10.6	4.0	v + h	x
12 / 10	2.2	15.5	5.9	v + h	x
12 / 13	3.0	---	7.8	v	x ⁴⁾
12 / 17	3.7	---	9.1	v	x ³⁾⁴⁾
12 / 21	5.5	---	13.7	v	---
12 / 25	5.5	---	13.7	v	---

1) Capacitor run motors (PSC motors) with starter.
 2) v = vertical and h = inclined / horizontal.
 3) Always check and make sure that the operating pressure of Controlmatic / Cervomatic units is not exceeded.
 4) 3~ only

Note : Use a cooling shroud for horizontal installation.

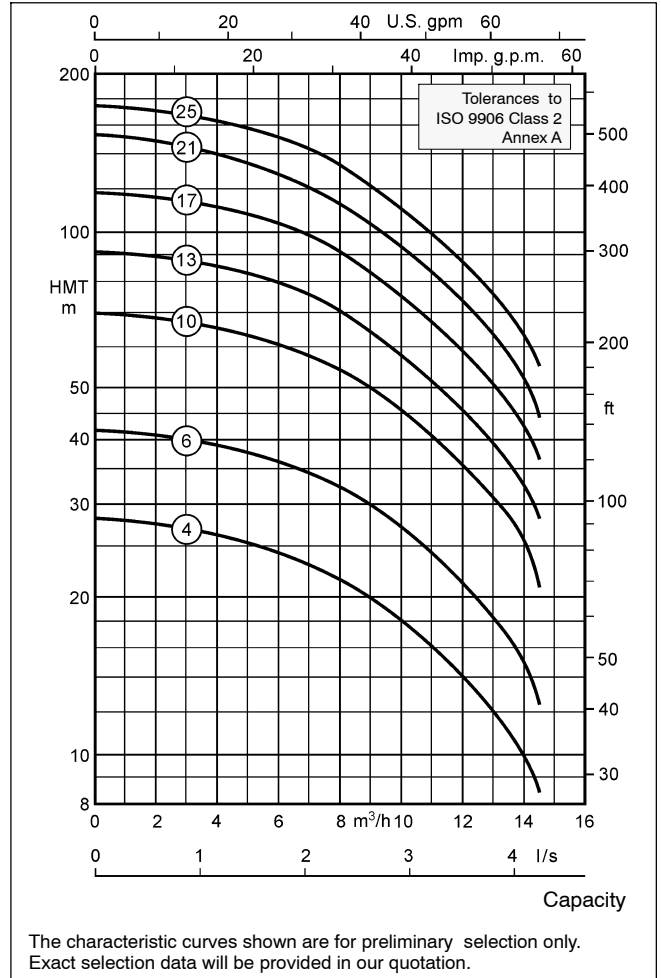

The characteristic curves shown are for preliminary selection only. Exact selection data will be provided in our quotation.

Dimensions / Weights / Ident. Numbers / Horizontal Installation

Pump unit S 100D	1~ / 230 V				3~ / 400 V				C
	L _A ≈ mm	m _A ≈ kg	Ident No.	A ≈ mm	L _A ≈ mm	m _A ≈ kg	Ident No.	A ≈ mm	
12 / 4	865	17.3	39 022 562	613	805	14.7	39 022 606	585	G 2"
12 / 6	1000	19.3	39 022 563	739	945	16.9	39 022 607	707	
12 / 10	1295	24.6	39 022 564	991	1195	20.0	39 022 608	938	
12 / 13	---	---	---	---	1425	24.2	39 022 609	---	
12 / 17	---	---	---	---	1815	32.2	39 022 610	---	
12 / 21	---	---	---	---	2185	40.2	39 022 611	---	
12 / 25	---	---	---	---	2400	42.0	39 022 612	---	

For information on cooling shroud refer to page 20.

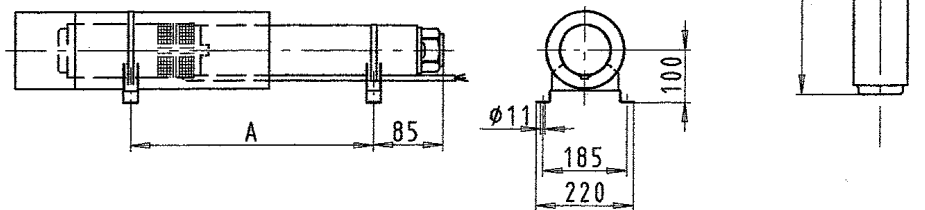

Accessories: UPA Control for dry running protection using 1 or 3 immersion electrodes, see page 21.

Scope of Supply for Single-phase A.C. Motors DN 100 (1~)

A starter for **single-phase a.c. motors** in PSC design (with integrated run capacitor and motor protection) is included in the scope of supply.

Permissible Cable Lengths

ΔU up to 3 %, direct starting and t up to + 30 °C

Current / Voltage	Motor rating kW	Cable lengths for cable cross-section in ... mm ²			
		1.5	2.5	4.0	6.0
1~/ 230 V (PSC)	0.37	72 m	120 m	190 m	284 m
	0.55	60 m	100 m	159 m	236 m
	0.75	47 m	79 m	125 m	186 m
	1.10	30 m	50 m	80 m	118 m
	1.50	26 m	43 m	68 m	101 m
	2.20	20 m	32 m	52 m	77 m
3~/ 400 V	0.37	752 m	-	-	-
	0.55	483 m	-	-	-
	0.75	368 m	614 m	-	-
	1.10	242 m	403 m	645 m	-
	1.50	194 m	322 m	516 m	-
	2.20	131 m	218 m	350 m	525 m
	3.00	100 m	165 m	265 m	397 m
	3.70	80 m	135 m	215 m	323 m
	5.50	55 m	90 m	143 m	215 m

Technical Data - Cooling Shroud

Pump unit S 100D	Installation ¹⁾	Dimension (dia. x length) and motor type (kW)	Cooling Shroud Ident No.	Strainer Ident No.	Support feet Ident No.
1/7 to 1/20 1/25 to 1/30	v+h v	Ø115 (130) x 400 for motor up to 0.75 kW (1~) or up to 0.75 kW (3~) Weight 1.5 kg	90 065 490	90 065 494 Ø115x117 0.3 kg	90 065 495 Set = 2 pc. 0.6 kg
2/7 to 2/15 4/3 to 4/8 7/4	v+h v+h v+h				
1/35 to 1/50	v				
2/18 to 2/27 2/30	v+h v				
4/11 to 4/16 7/6 to 7/8 12/4 to 12/6	v+h v+h v+h				
2/33 to 2/50 4/21 4/24 to 4/33 7/11 to 7/18 12/10 12/13	v v+h v v+h v+h v	Ø115 (130) x 625 for motor up to 2.2 kW (1~) or up to 3.0 kW (3~) Weight 2.0 kg	90 065 492		
4/40	v				
7/23 to 7/33 12/17 to 12/25	v v	Ø115 (130) x 800 for motor up to 5.5 kW (3~) Weight 2.5 kg	90 065 493		

¹⁾ v = vertical, h = inclined / horizontal

Accessories: UPA Control for Dry Running Protection (using 3 immersion electrodes)

S 100D-1/.. 1~								S 100D-1/... 3~					
Relais Télémécanique (A)	Electrode (Qty.)	7 9 12	14 16 20	25 30	35 40	50	Ident No.	Relais Télémécanique (A)	Electrode (Qty.)	7 9 12	14 to 30	35 40 50	Ident No.
2.5 to 4.0	(3)	X					40 980 891	1.0 to 1.6	(3)	X			40 980 887
4.0 to 6.0	(3)		X				40 980 893	1.6 to 2.5	(3)		X		40 980 889
5.5 to 8.0	(3)			X			40 990 895	2.5 to 4.0	(3)			X	40 980 891
7.0 to 10	(3)				X		40 980 897						
9.0 to 13	(3)					X	40 980 899						

S 100D-2/.. 1~									S 100D-2/... 3~						
Relais Télémécanique (A)	Electrode (Qty.)	7	11	15	18 20 22	27 30	33 38 44	Ident No.	Relais Télémécanique (A)	Electrode (Qty.)	7	11 15	18 to 30	33 44 50	Ident No.
2.5 to 4.0	(3)	X						40 980 891	1.0 to 1.6	(3)	X				40 980 887
4.0 to 6.0	(3)		X					40 980 893	1.6 to 2.5	(3)		X			40 980 889
5.5 to 8.0	(3)			X				40 990 895	2.5 to 4.0	(3)			X		40 980 891
7.0 to 10	(3)				X			40 980 897	5.5 to 8.0	(3)				X	40 980 895
9.0 to 13	(3)					X		40 980 899							
12 to 18	(3)						X	40 984 811							

S 100D-4/.. 1~									S 100D-4/... 3~							
Relais Télémécanique (A)	Electrode (Qty.)	3	6	8	11	16	21 24	Ident No.	Relais Télémécanique (A)	Electrode (Qty.)	3	6 8	11 16	21 24	33 40	Ident No.
2.5 to 4.0	(3)	X						40 980 891	1.0 to 1.6	(3)	X					40 980 887
4.0 to 6.0	(3)		X					40 980 893	1.6 to 2.5	(3)		X				40 980 889
5.5 to 8.0	(3)			X				40 990 895	2.5 to 4.0	(3)			X			40 980 891
7.0 to 10	(3)				X			40 980 897	5.5 to 8.0	(3)				X		40 980 895
9.0 to 13	(3)					X		40 980 899	7.0 to 10	(3)					X	40 980 897
12 to 18	(3)						X	40 984 811								

S 100D-7/.. 1~							S 100D-7/... 3~								
Relais Télémécanique (A)	Electrode (Qty.)	4	6	8	11 13	Ident No.	Relais Télémécanique (A)	Electrode (Qty.)	4	6 8	11 13 18	23	28 33	Ident No.	
5.5 to 8.0	(3)	X				40 990 895	1.6 to 2.5	(3)	X					40 980 889	
7.0 to 10	(3)		X			40 980 897	2.5 to 4.0	(3)		X				40 980 891	
9.0 to 13	(3)			X		40 980 899	5.5 to 8.0	(3)			X			40 980 895	
12 to 18	(3)				X	40 984 811	7.0 to 10	(3)				X		40 980 897	
							12 to 18	(3)					X		40 984 811

S 100D-12/.. 1~						S 100D-12/... 3~						
Relais Télémécanique (A)	Electrode (Qty.)	4	6	10	Ident No.	Relais Télémécanique (A)	Electrode (Qty.)	4 6	10	13 17	21 25	Ident No.
7.0 to 10	(3)	X			40 980 897	2.5 to 4.0	(3)	X				40 980 891
9.0 to 13	(3)		X		40 980 899	5.5 to 8.0	(3)		X			40 980 895
12 to 18	(3)			X	40 984 811	7.0 to 10	(3)			X		40 980 897
						12 to 18	(3)				X	40 984 811

Applications

- Domestic and general water supply
- Irrigation and spray irrigation
- Lowering ground water levels
- Fountains
- Pressure boosting
- Air-conditioning systems
- Fire protection
- Cooling water cycles

Maximum permissible amount of suspended sand: 50 g/m³

Operating Data

Capacity	Q	up to 15 m ³ /h (250 l/min)
Head	H	up to 400 m
Temperature of fluid handled	t	30 °C
Motor ratings	P _N	up to 7.5 kW

Design

Multistage centrifugal pump with components made of stainless steel and additional bearing for each stage. The stage casings are connected by means of tie bolts on radial pumps, and by means of studs on mixed-flow pumps.

Submersible canned motor: Franklin Electric pre-filled motors, corrosion free, NEMA shaft end, 50 Hz

- Single-phase and three-phase motor type Super Stainless
- With separate lead
- Direct starting, max starts per hour: 20
- Type of enclosure: IP 68
- Insulation: Class B

Designation (Example)

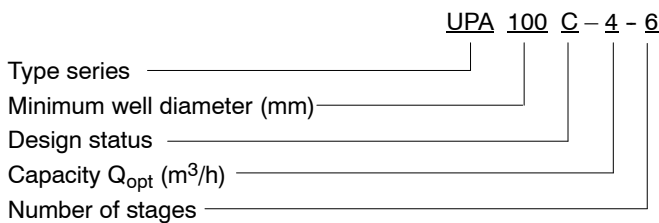

Certification

Quality management certified to ISO 9001

Submersible Borehole Pumps for Well Diameters of 100 mm (4 inches)

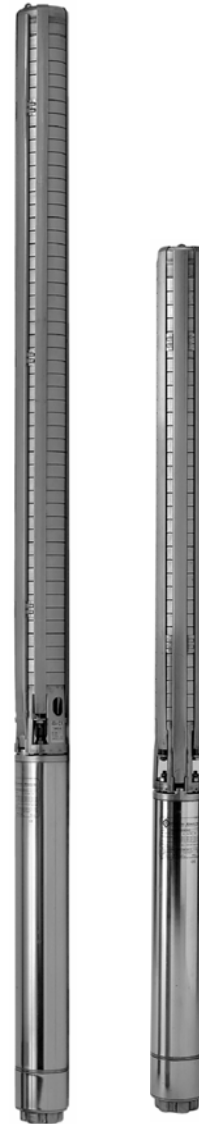

Product Features

- Very sturdy design
- All components made of stainless steel
- Suitable for installation in narrow deep wells
- High efficiency
- Totally enclosed motor
- Motor designed for maximum pump output
- Low noise level
- For vertical or horizontal installation
- Check valve protected against blocking
- Pre-filled motor; no risk of contamination of the pumped water

Selection Chart (Ranges on offer)

n ≈ 2900 rpm

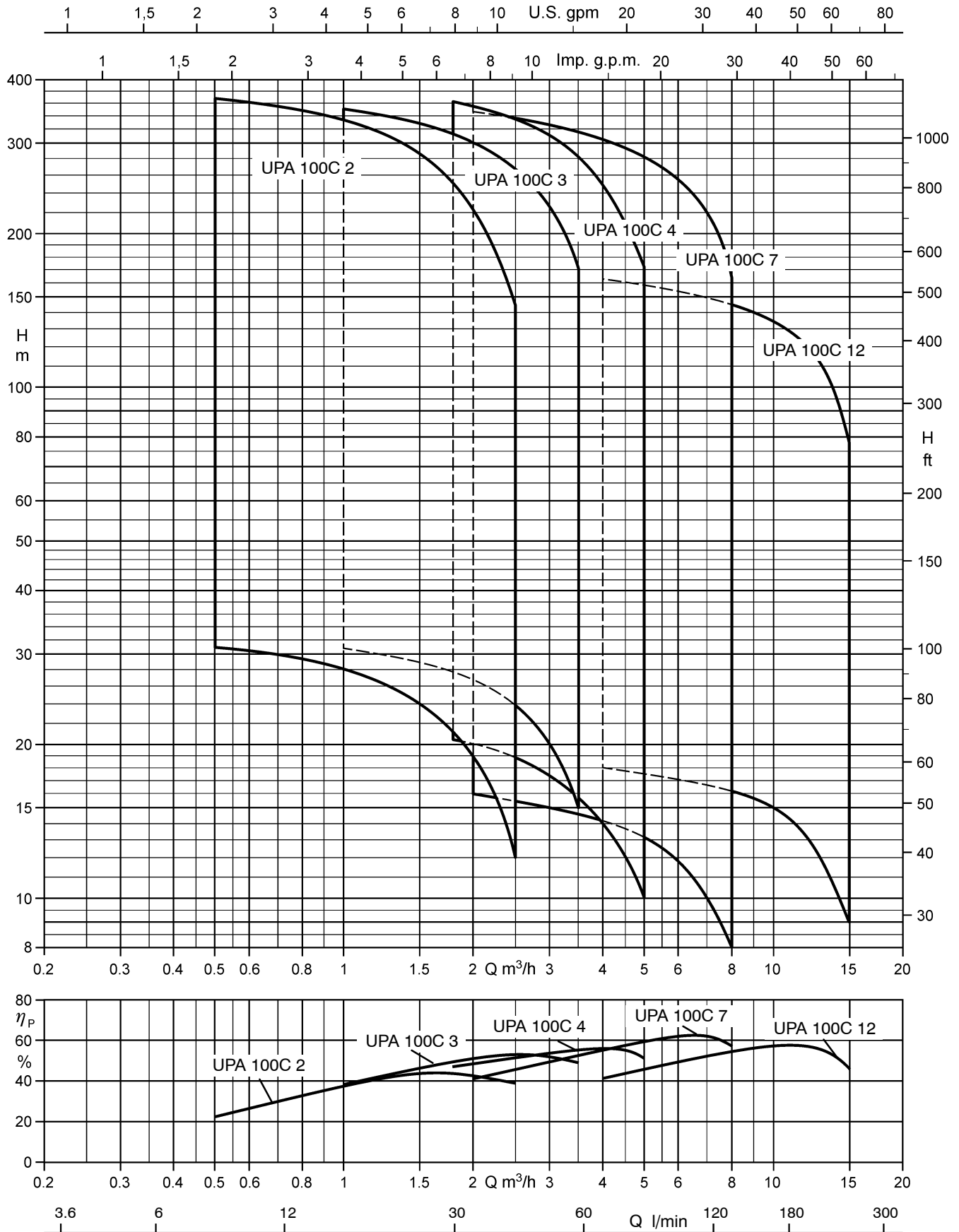

Materials

Component	C1
Pump ...	
Diffuser	stainless steel AISI 304
Upper diffuser	
Lower diffuser	
Impeller	
Pump shaft with Nema coupling	
Suction casing	
Suction filter	
Discharge casing	
Spacer sleeve	
Hook	
Seal ring	NBR + AISI 316
Upper bearing bush	NBR + AISI 316
Intermediate bearing bush	NBR
Valve face	NBR + AISI 316
Motor ...	
Shaft	stainless steel AISI 304 SS
Bearing housing	stainless steel AISI 304 SS
Stator case	stainless steel AISI 304 SS

Drive

Type	submersible canned motor
Connection	NEMA standard
Enclosure	IP 68
Frequency f	50 Hz
Type of current	single-phase and three-phase
Rated voltage U	1~ 230 V, 3~ 400 V,

Rated power P _N	up to 7.5 kW
Voltage fluctuations	up to +/- 10 %
Frequency of starts	up to 20 / h
Min. delay before restarting	3 min

A start box with integrated phase-shifting capacitor and thermal protection is included in the scope of supply of single-phase pump sets in PSC design.

Starting Mode

Direct on line.

Temperatures

The UPA 100 C submersible borehole pump is designed for use in water with temperatures of up to +30 °C.

Direction of Rotation of the Pump

Clockwise rotation (when looking at the drive shaft end).

Discharge Nozzle

UPA 100C 2 - 3 - 4:	Rp 1 ¹ / ₂ "
UPA 100C 7 - 12	Rp 2"

Installation

Vertical or horizontal installation without restriction. In order to guarantee the dissipation of the motor heat it will be necessary to install a device guiding the flow along the motor (cooling jacket, flow inducer sleeve, etc.) in horizontal installation.

Variants Available on Request

- Higher fluid temperatures
- Voltages above 500 V
- Other frequencies

Permissible Cable Lengths

ΔU up to 3 % and temperatures up to +30 °C.

Type of current / Voltage	Drive rating	Length of cable in m for cross-section in ... mm ²				
		1.5	2.5	4.0	6.0	10.0
1~ 230 V 50 Hz	0.37	72	120	190	248	-
	0.55	60	100	159	236	-
	0.75	47	79	125	186	-
	1.10	30	50	80	118	-
	1.50	26	43	68	101	-
	2.20	20	32	52	77	-
3~ 400 V 50 Hz	0.37	752	-	-	-	-
	0.55	483	-	-	-	-
	0.75	368	614	-	-	-
	1.10	242	403	645	-	-
	1.50	194	322	516	-	-
	2.20	131	218	350	525	-
	3.30	100	165	265	397	-
	3.70	80	135	215	323	-
	4.00	74	124	195	295	-
	5.50	55	90	143	215	597
7.50	38	63	100	150	415	

Design Features

Optimised operating costs:
Check valve, built into the discharge chamber, designed for low loss of head.

Hydraulic profiles are optimized for the attainment of high efficiencies.

Oversized intermediate bearings located at each pump stage to align the shaft, specially designed to optimize lubrication.

Coupling and flange suitable for motors with pump mounting dimensions in accordance with NEMA standards.

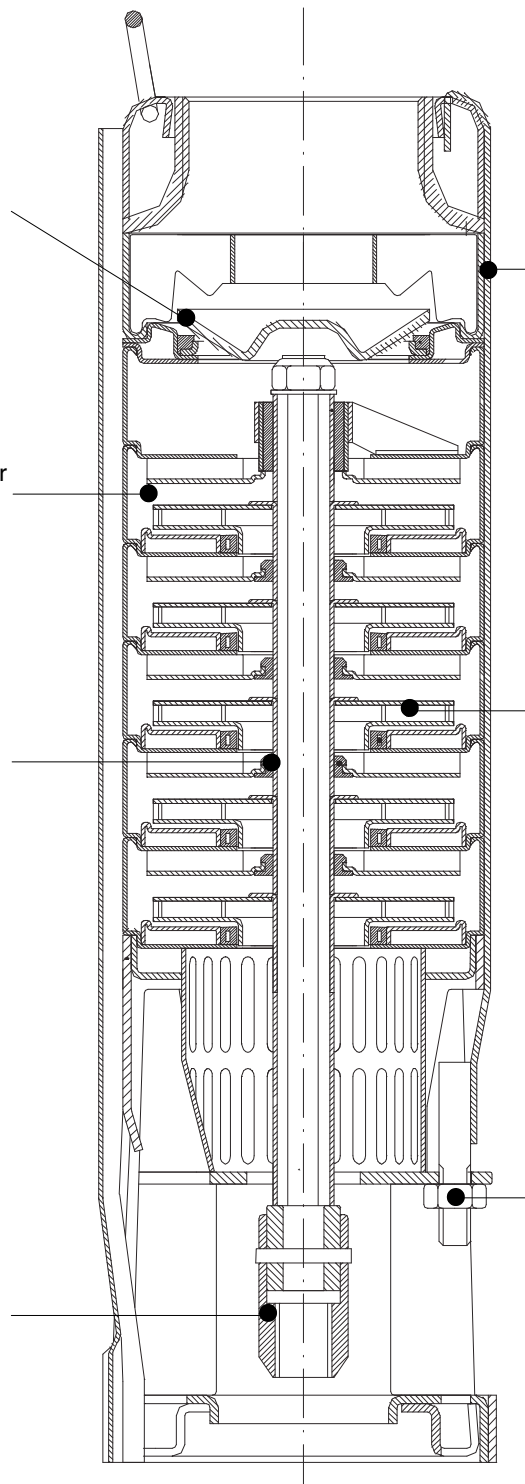

Resistance to corrosion and abrasion, i.e. the same inherent qualities of stainless steel.

Reliable in service:
Very strong construction: minimum thickness of stainless sheet steel of 1 mm, 6 spot welding on each vane, special top bearing for every pump.

Friendly service:
Great ease of dismantling and assembly.
Easy-to-replace wear-rings and bearings.

UPA 100C 2 - ...

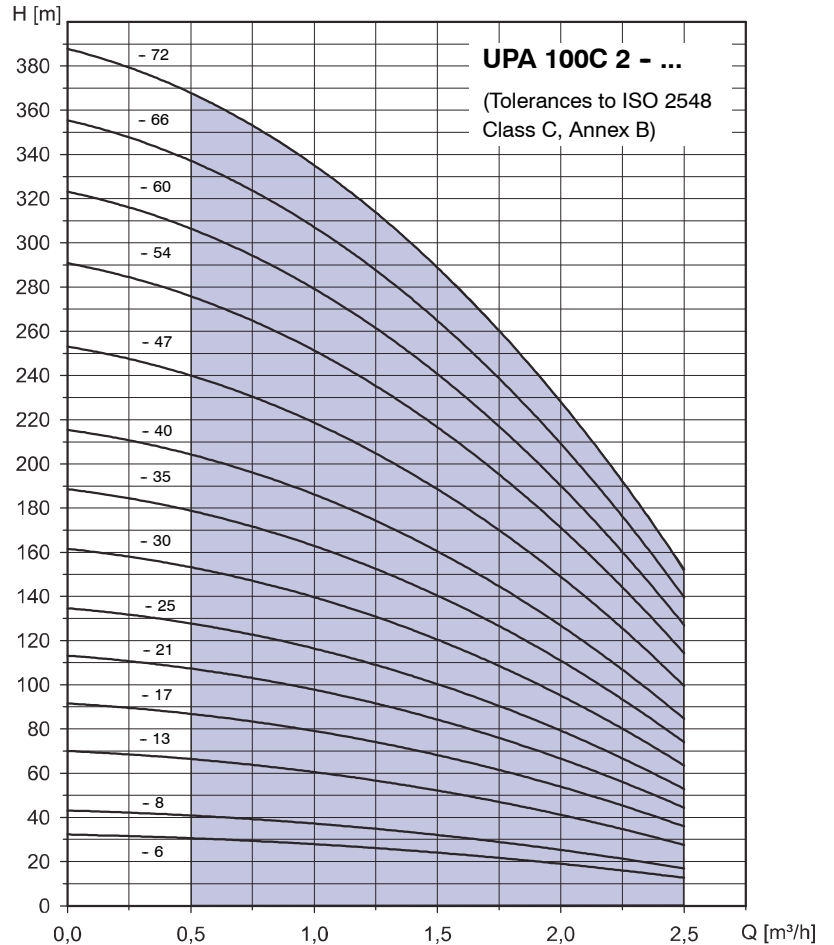
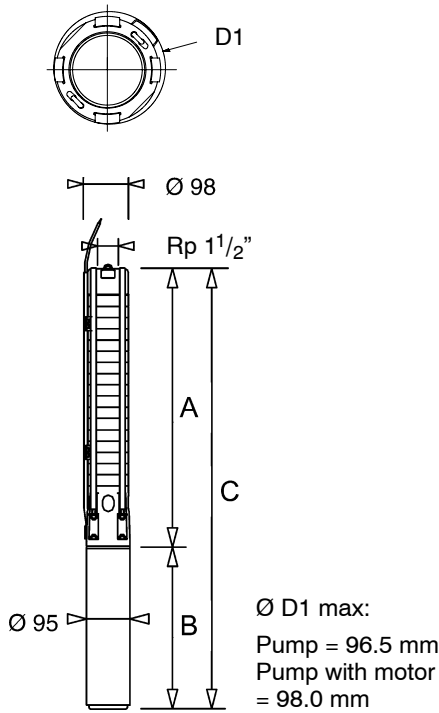

Pump set UPA 100C 2 -..	Rated power (Motor) P _N kW	Rated power (Motor) P _N hp	Rated current for	
			1~ 220 V I _N ¹⁾ A	3~ 400 V I _N A
6	0.37	0.5	3.2	0.9
8	0.37	0.5	3.6	1.1
13	0.55	0.75	5.7	1.5
17	0.75	1	6.9	2.0
21	1.1	1.5	8.0	2.8
25	1.1	1.5	8.9	3.0
30	1.5	2	9.5	3.3
35	1.5	2	11.1	3.8
40	2.2	3	12.1	5.1
47	2.2	3	14.5	5.4
54	2.2	3	15.9	5.6
60	3.0	4	-	6.8
66	3.0	4	-	7.2
72	3.0	4	-	7.5

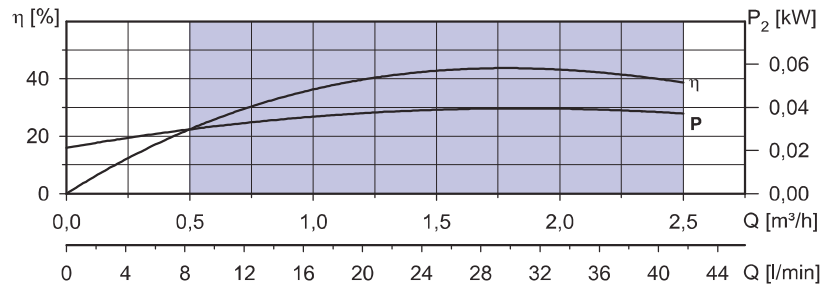

Operating range: 0.5 - 2.5 m³/h
 Q_{min} = 0.5 m³/h
 Q_{max} = End of characteristic curve

1) Capacitor run motors (PSC motors) with starter.

The characteristic curves shown are for preliminary selection only.
 Exact selection data will be provided in our quotation.

Dimensions / Weights / Ident. Numbers

Pump set UPA 100C 2 -..	1~ / 220 V				3~ / 400 V			m _A ≈ kg
	A ≈ mm	B ≈ mm	C ≈ mm	Ident. No.	B ≈ mm	C ≈ mm	Ident. No.	
6	349	242	591	90 065 300	223	572	90 065 387	11.1
8	397	242	639	90 065 301	223	620	90 065 388	11.7
13	517	271	788	90 065 302	242	759	90 065 389	14.3
17	623	299	922	90 065 303	271	894	90 065 390	17.0
21	711	327	1038	90 065 304	299	1010	90 065 391	19.5
25	807	327	1134	90 065 305	299	1106	90 065 392	20.8
30	928	356	1284	90 065 306	327	1255	90 065 393	23.7
35	1048	356	1404	90 065 307	327	1375	90 065 394	25.4
40	1169	460	1629	90 065 308	356	1525	90 065 395	28.1
47	1338	460	1798	90 065 309	356	1694	90 065 396	29.5
54	1506	460	1966	90 065 310	356	1862	90 065 397	32.6
60	1651	-	-	-	423	2074	90 065 398	37.0
66	1796	-	-	-	423	2219	90 065 399	38.9
72	1941	-	-	-	423	2364	90 065 400	40.9

For horizontal installation, a device guiding the flow along the motor (cooling shroud, flow inducer sleeve, etc.) will be required.

Accessories: UPA Control for dry running protection see page 32.

UPA 100C 3 - ...

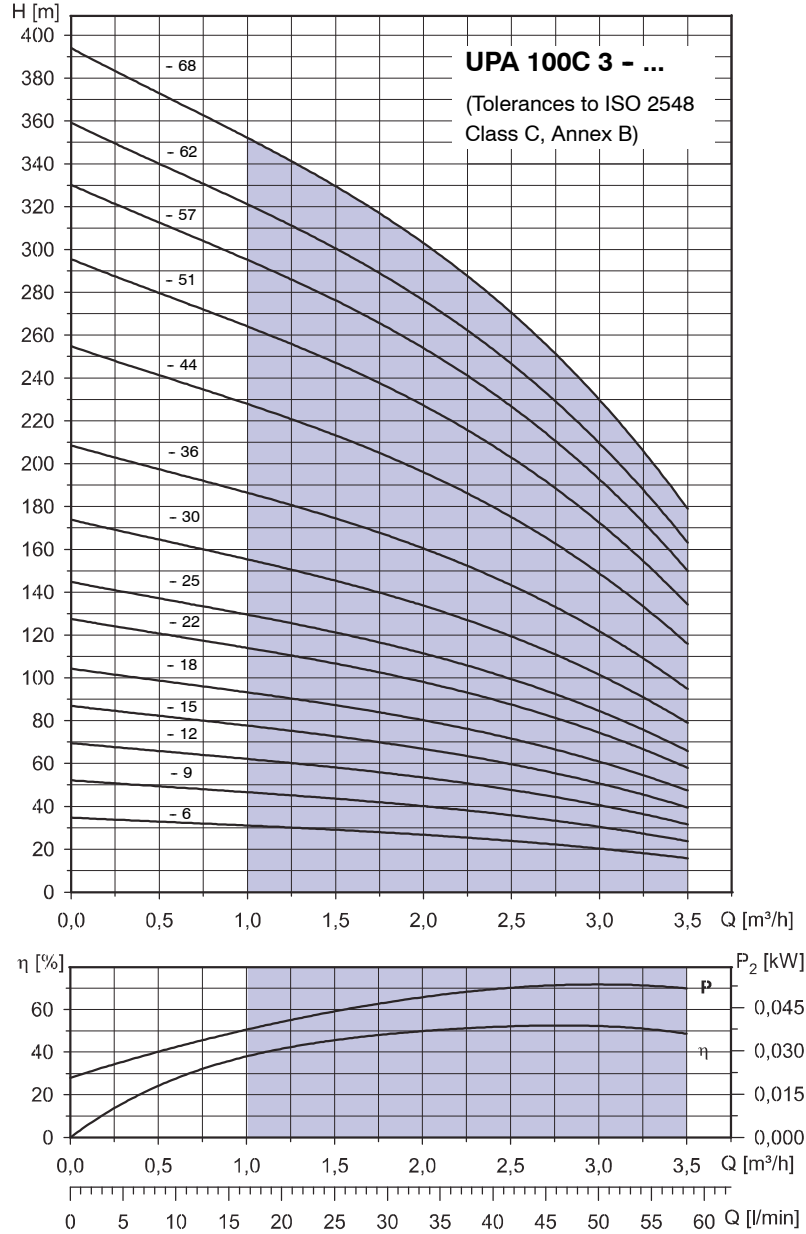
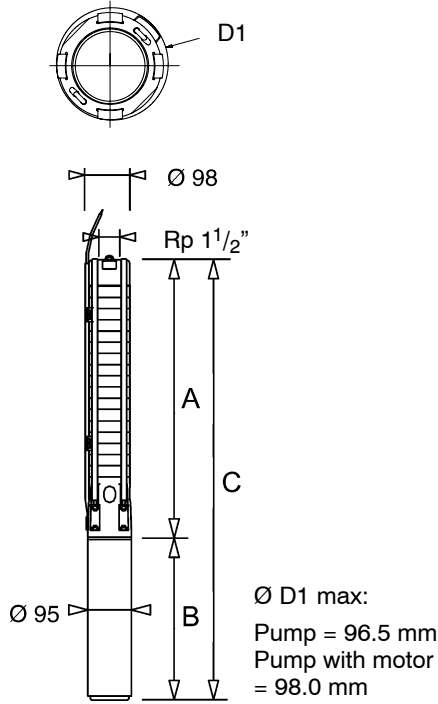

Pump set UPA 100C 3 -...	Rated power (Motor) P_N kW	Rated power (Motor) P_N hp	Rated current for	
			1~ 220 V I_N¹⁾ A	3~ 400 V I_N A
6	0.37	0.5	3.6	1.1
9	0.55	0.75	5.7	1.5
12	0.75	1.0	6.9	2.0
15	1.1	1.5	8.7	2.9
18	1.1	1.5	8.9	3.0
22	1.5	2.0	9.8	3.6
25	1.5	2.0	11.1	3.8
30	2.2	3.0	12.5	5.2
36	2.2	3.0	15.9	5.6
44	3.0	4.00	-	7.0
51	3.0	4.0	-	7.2
57	3.7	5.0	-	8.8
62	3.7	5.0	-	9.1
68	4.0	5.5	-	10.00

1) Capacitor run motors (PSC motors) with starter.

Operating range: 1.0 - 3.5 m³/h
 Q_{min} = 1.0 m³/h
 Q_{max} = End of characteristic curve

The characteristic curves shown are for preliminary selection only.
 Exact selection data will be provided in our quotation.

Dimensions / Weights / Ident. Numbers

Pump set UPA 100C 3 -...	1~ / 220 V				3~ / 400 V			m _A ≈ kg
	A ≈ mm	B ≈ mm	C ≈ mm	Ident. No.	B ≈ mm	C ≈ mm	Ident. No.	
6	349	242	591	90 065 311	223	572	90 065 401	11.1
9	421	271	692	90 065 312	242	663	90 065 402	13.1
12	493	299	792	90 065 313	271	764	90 065 403	15.4
15	566	327	883	90 065 314	299	865	90 065 404	17.1
18	638	327	965	90 065 315	299	937	90 065 405	18.5
22	734	356	1090	90 065 316	327	1061	90 065 406	21.1
25	807	356	1163	90 065 317	327	1134	90 065 407	22.1
30	928	460	1388	90 065 318	356	1284	90 065 408	25.1
36	1072	460	1532	90 065 319	356	1428	90 065 409	27.2
44	1265	-	-	-	423	1688	90 065 410	32.3
51	1434	-	-	-	423	1857	90 065 411	34.7
57	1579	-	-	-	545	2124	90 065 412	41.5
62	1699	-	-	-	545	2244	90 065 413	43.2
68	1844	-	-	-	583	2427	90 065 414	48.3

For horizontal installation, a device guiding the flow along the motor (cooling shroud, flow inducer sleeve, etc.) will be required.

Accessories: UPA Control for dry running protection see page 32.

UPA 100C 4 - ...

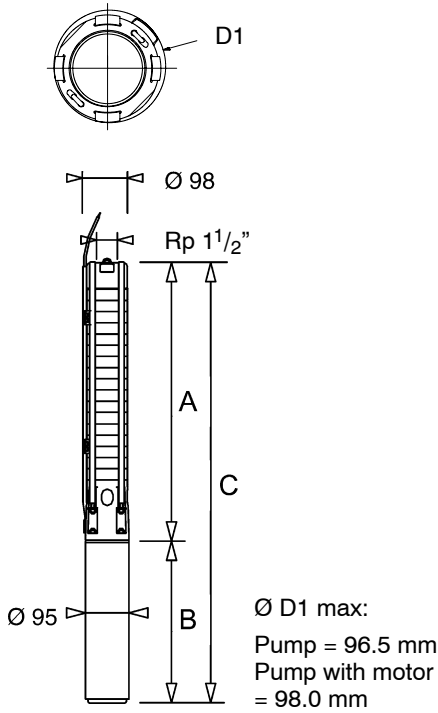

Pump set UPA 100C 4 - ...	Rated power (Motor) P_N kW	Rated power (Motor) P_N hp	Rated current for	
			1~ 220 V I_N¹⁾ A	3~ 400 V I_N A
4	0.37	0.5	3.6	1.1
7	0.55	0.75	5.7	1.5
9	0.75	1.0	6.9	2.0
14	1.1	1.5	8.9	3.0
19	1.5	2.0	11.1	3.8
24	2.2	3.0	12.8	5.3
29	2.2	3.0	15.9	5.6
34	3.0	4.0	-	7.0
39	3.0	4.0	-	7.2
45	3.7	5.0	-	8.8
50	3.7	5.0	-	9.1
54	4.0	5.5	-	10.0
60	5.5	7.5	-	11.5
66	5.5	7.5	-	12.5
72	5.5	7.5	-	13.2

¹⁾ Capacitor run motors (PSC motors) with starter.

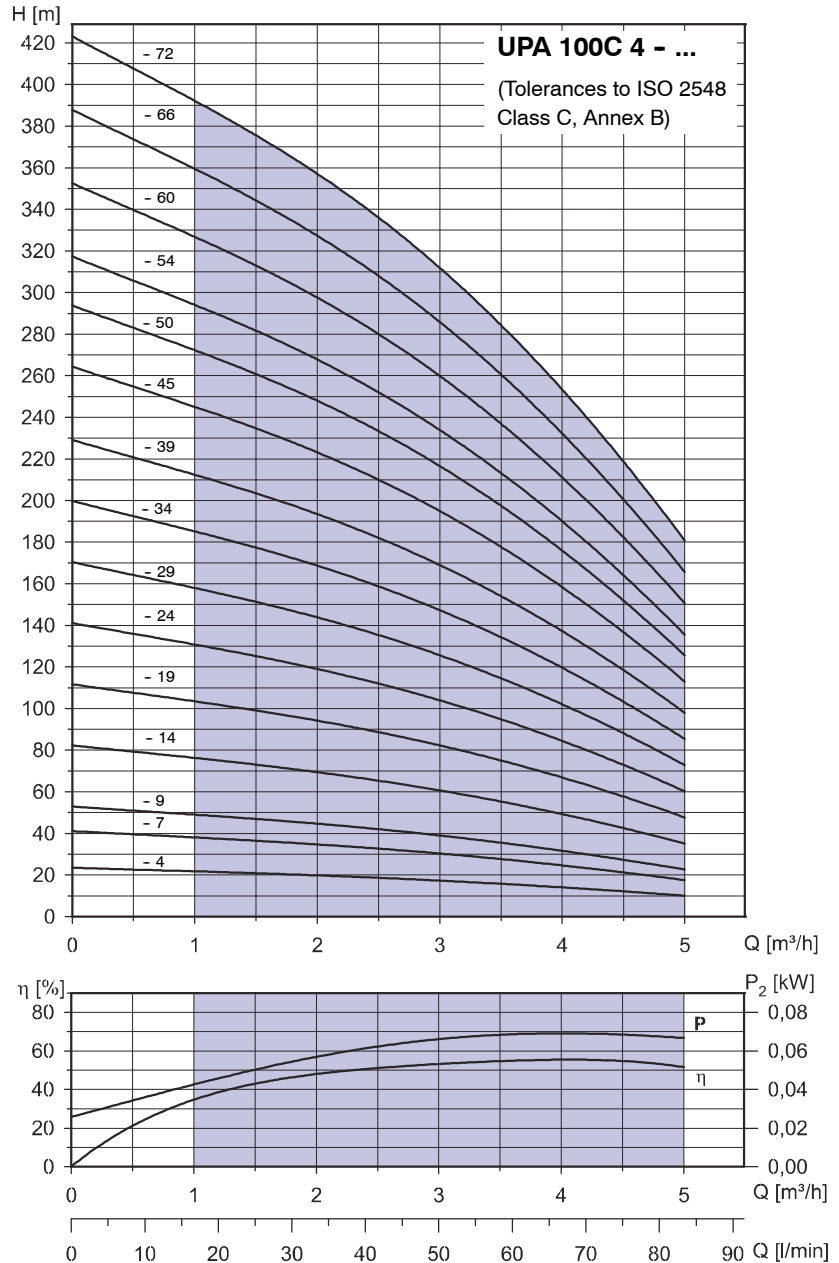

Operating range: 1.0 - 5.0 m³/h
 Q_{min} = 1.0 m³/h
 Q_{max} = End of characteristic curve

The characteristic curves shown are for preliminary selection only.
 Exact selection data will be provided in our quotation.

Dimensions / Weights / Ident. Numbers

Pump set UPA 100C 4 - ...	1~ / 220 V				3~ / 400 V			m _A ≈ kg
	A ≈ mm	B ≈ mm	C ≈ mm	Ident. No.	B ≈ mm	C ≈ mm	Ident. No.	
4	300	242	542	90 065 320	223	523	90 065 415	10.5
7	373	271	644	90 065 321	242	615	90 065 416	12.5
9	421	299	720	90 065 322	271	692	90 065 417	14.5
14	542	327	869	90 065 323	299	841	90 065 418	17.4
19	662	356	1018	90 065 324	327	989	90 065 419	20.4
24	783	460	1243	90 065 325	356	1139	90 065 420	23.5
29	903	460	1363	90 065 326	356	1259	90 065 421	25.2
34	1024	-	-	-	423	1447	90 065 422	29.4
39	1145	-	-	-	423	1568	90 065 423	31.1
45	1289	-	-	-	545	1834	90 065 424	38.0
50	1410	-	-	-	545	1955	90 065 425	39.7
54	1506	-	-	-	583	2089	90 065 426	44.3
60	1651	-	-	-	698	2349	90 065 427	51.6
66	1796	-	-	-	698	2494	90 065 428	53.7
72	1941	-	-	-	698	2639	90 065 429	55.7

For horizontal installation, a device guiding the flow along the motor (cooling shroud, flow inducer sleeve, etc.) will be required.

Accessories: UPA Control for dry running protection see page 32.

UPA 100C 7 - ...

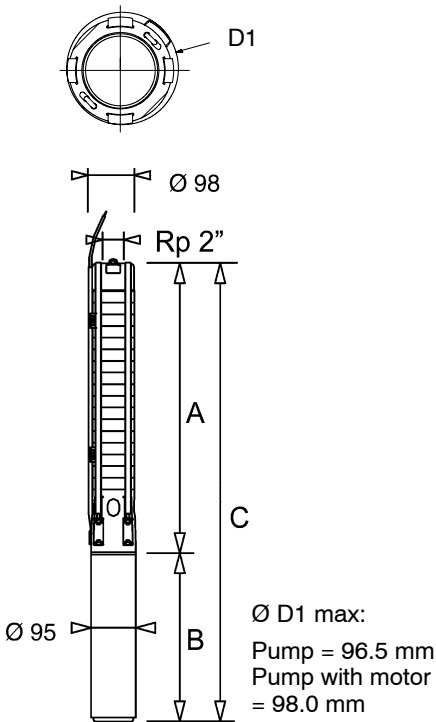

Pump set UPA 100C 7 - ..	Rated power (Motor) P_N kW	Rated power (Motor) P_N hp	Rated current for	
			1~ 220 V I_N¹⁾ A	3~ 400 V I_N A
3	0.37	0.5	3.6	1.1
4	0.55	0.75	5.7	1.5
6	0.75	1.0	6.9	2.0
9	1.1	1.5	8.9	3.0
13	1.5	2.0	11.1	3.8
16	2.2	3.0	12.8	5.2
19	2.2	3.0	15.9	5.6
23	3.0	4.0	-	6.6
26	3.0	4.0	-	7.2
29	3.7	5.0	-	8.3
32	3.7	5.0	-	9.1
34	4.0	5.5	-	10.0
39	5.5	7.5	-	11.5
44	5.5	7.5	-	12.5
49	5.5	7.5	-	13.2
54	7.5	10.0	-	17.5
59	7.5	10.0	-	18.3
64	7.5	10.0	-	19.1

¹⁾ Capacitor run motors (PSC motors) with starter.

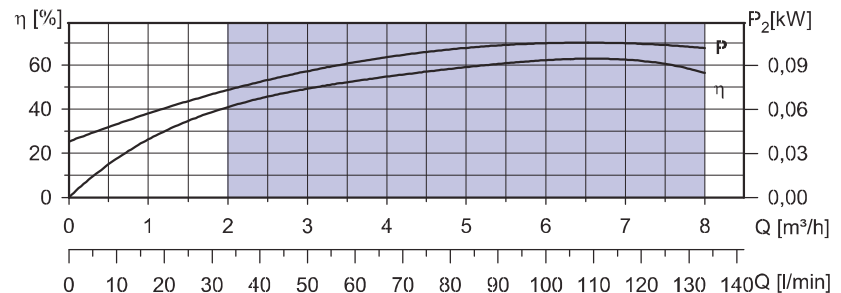
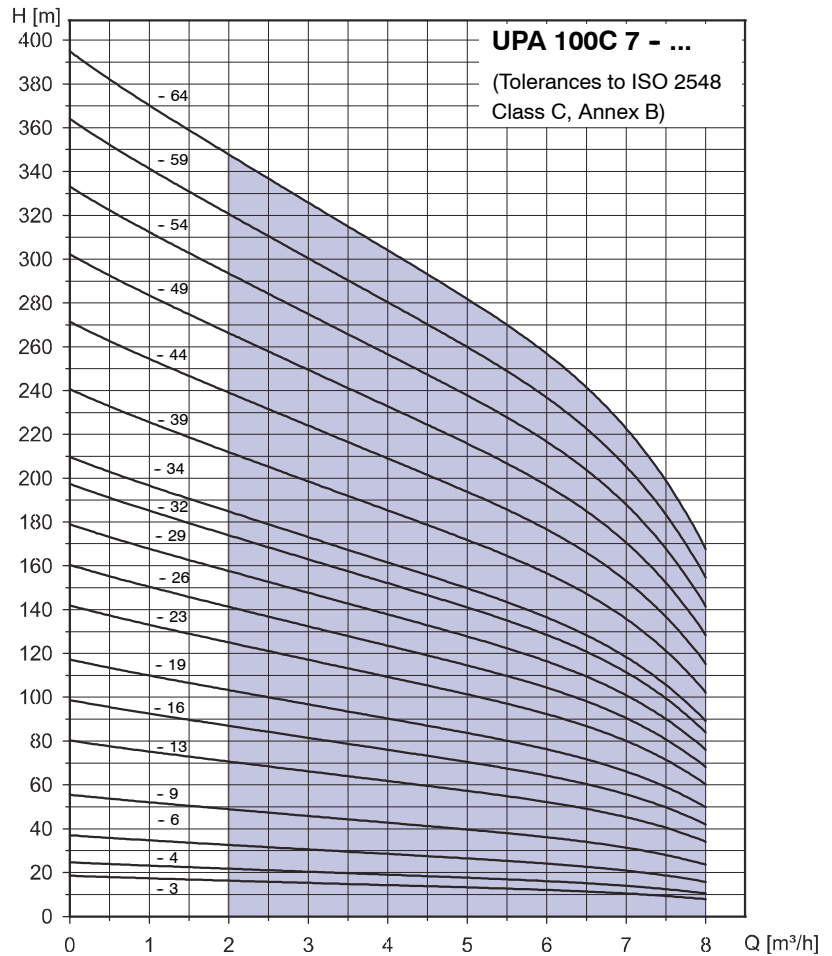

Operating range: 2.0 - 8.0 m³/h
 Q_{min} = 2.0 m³/h
 Q_{max} = End of characteristic curve

The characteristic curves shown are for preliminary selection only.
 Exact selection data will be provided in our quotation.

Dimensions / Weights / Ident. Numbers

Pump set UPA 100C 7 - ..	1~ / 220 V				3~ / 400 V			m _A = kg
	A ≈ mm	B ≈ mm	C ≈ mm	Ident. No.	B ≈ mm	C ≈ mm	Ident. No.	
3	276	242	519	90 065 327	223	500	90 065 430	10.2
4	300	271	571	90 065 328	242	542	90 065 431	11.5
6	349	299	648	90 065 329	271	620	90 065 432	13.5
9	421	327	748	90 065 330	299	720	90 065 433	15.8
13	517	356	873	90 065 331	327	844	90 065 434	18.5
16	590	460	1050	90 065 332	356	946	90 065 435	21.0
19	662	460	1122	90 065 333	356	1118	90 065 436	22.0
23	759	-	-	-	423	1182	90 065 437	25.9
26	831	-	-	-	423	1254	90 065 438	27.0
29	903	-	-	-	545	1448	90 065 439	33.0
32	976	-	-	-	545	1521	90 065 440	34.0
34	1024	-	-	-	583	1607	90 065 441	37.9
39	1145	-	-	-	698	1843	90 065 442	45.0
44	1266	-	-	-	698	1964	90 065 443	46.8
49	1386	-	-	-	698	2084	90 065 444	48.6
54	1506	-	-	-	774	2280	90 065 445	53.9
59	1628	-	-	-	774	2402	90 065 446	55.7
64	1748	-	-	-	774	2522	90 065 447	59.5

For horizontal installation, a device guiding the flow along the motor (cooling shroud, flow inducer sleeve, etc.) will be required.
Accessories: UPA Control for dry running protection see page 32.

UPA 100C 12 - ...

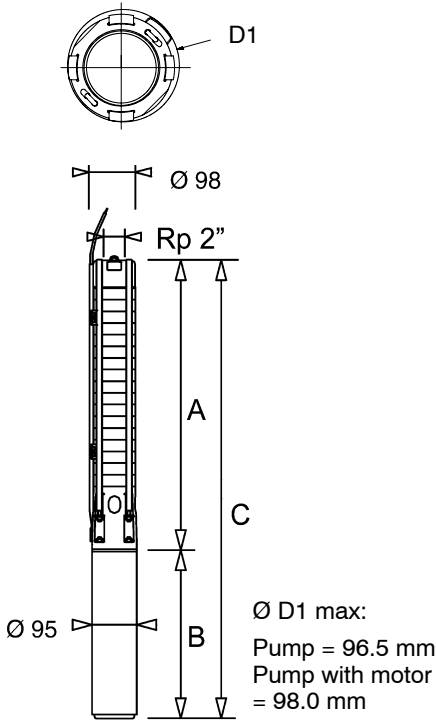

Pump set UPA 100C 12 -..	Rated power (Motor) P_N kW	Rated power (Motor) P_N hp	Rated current for	
			1~ 220 V I_N¹⁾ A	3~ 400 V I_N A
3	1.1	1.5	8.9	3.0
5	1.5	2.0	11.1	3.8
8	2.2	3.0	15.9	5.6
10	3.0	4.0	-	7.2
13	3.7	5.0	-	9.1
14	4.0	5.5	-	10.0
17	5.5	7.5	-	12.5
20	5.5	7.5	-	13.2
24	7.5	10.0	-	18.3
27	7.5	10.0	-	19.1

1) Capacitor run motors (PSC motors) with starter.

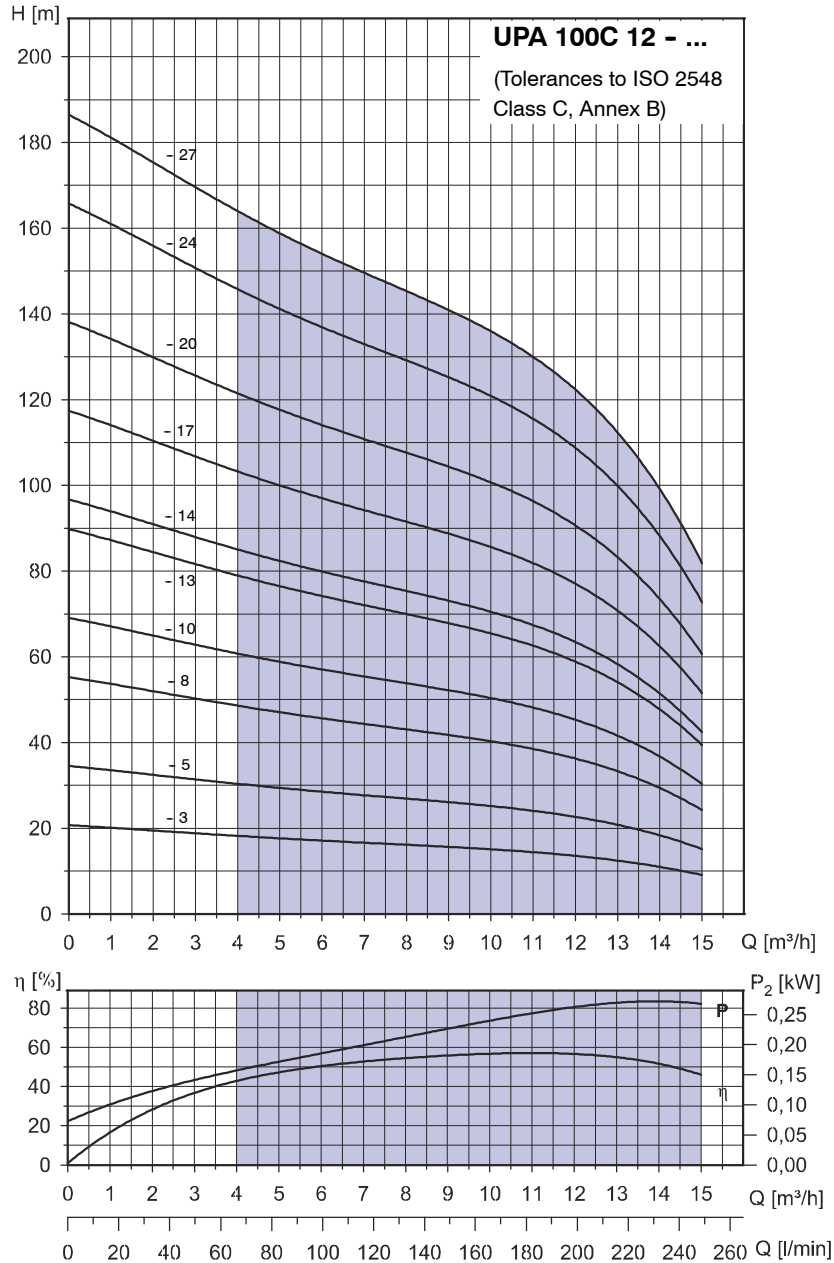

Operating range: 4.0 - 15.0 m³/h
 Q_{min} = 4.0 m³/h
 Q_{max} = End of characteristic curve

The characteristic curves shown are for preliminary selection only.
 Exact selection data will be provided in our quotation.

Dimensions / Weights / Ident. Numbers

Pump set UPA 100C 12 -..	1~ / 220 V				3~ / 400 V			m _A ≈ kg
	A ≈ mm	B ≈ mm	C ≈ mm	Ident. No.	B ≈ mm	C ≈ mm	Ident. No.	
3	327	327	654	90 065 334	299	626	90 065 448	13.9
5	405	356	761	90 065 335	327	732	90 065 449	16.0
8	522	460	982	90 065 336	356	878	90 065 450	18.7
10	600	-	-	-	423	1023	90 065 451	22.1
13	717	-	-	-	545	1265	90 065 452	28.4
14	756	-	-	-	583	1339	90 065 453	29.6
17	873	-	-	-	698	1571	90 065 454	36.4
20	990	-	-	-	698	1688	90 065 455	37.7
24	1146	-	-	-	774	1920	90 065 456	44.1
27	1263	-	-	-	774	2037	90 065 457	45.4

For horizontal installation, a device guiding the flow along the motor (cooling shroud, flow inducer sleeve, etc.) will be required.

Accessories: UPA Control for dry running protection see page 32.

UPA Control
Accessory: UPA Control for dry running protection (using 3 immersion electrodes)

Relay (A)	Ident. No.
1.0 to 1.6	40 980 887
1.6 to 2.5	40 980 889
2.5 to 4.0	40 980 891
4.0 to 6.0	40 980 893
5.5 to 8.0	40 980 895
7.0 to 10	40 980 897
9.0 to 13	40 980 899
12 to 18	40 984 811
18 to 25	90 052 649

Combinations of UPA 100C with UPA Control 1~ 230 V

Ident. No.	40 980 891	40 980 893	40 980 895	40 980 897	40 980 899	40 984 811
	2.5 to 4.0	4.0 to 6.0	5.5 to 8.0	7.0 to 10	9.0 to 13	12 to 18
UPA 100C 2	6, 8	13	17	21, 25, 30	35, 40	47, 54
UPA 100C 3	6	9	12	15, 18, 22	25, 30	36
UPA 100C 4	4	7	9	14	19	24, 29
UPA 100C 7	3	4	6	9	13	16, 19
UPA 100C 12	-	-	-	3	5	8

Combinations of UPA 100C with UPA Control 3~ 400 V

Ident. No.	40 980 887	40 980 889	40 980 891	40 980 893	40 980 895	40 980 897	40 980 899	40 984 811	90 052 649
	1.0 to 1.6	1.6 to 2.5	2.5 to 4.0	4.0 to 6.0	5.5 to 8.0	7.0 to 10	9.0 to 13	12 to 18	18 to 25
UPA 100C 2	6, 8, 13	17	21, 25, 30, 35	40, 47, 54	60, 66, 72	-	-	-	-
UPA 100C 3	6	9, 12	15, 18, 22, 25	30, 36	44, 51	57, 62	68	-	-
UPA 100C 4	4, 7	9	14, 19	24, 29	34, 39	45, 50	54, 60, 66	72	-
UPA 100C 7	3, 4	6	9, 13	16, 19	23, 26	29, 32	34, 39, 44	49, 54	59, 64
UPA 100C 12	-	-	3, 5	8	10	13	14	17, 20	24, 27

Accessory: cooling shroud made on stainless steel 1.4301

UPA 100C	Type of installation	Dimensions (diameter x length) mm and motor type (kW)	Cooling shroud Ident. No.	Suction strainer Ident. No.	Pedestals Ident. No.
2/6 to 2/13 3/6 to 3/9 4/4 to 4/7 7/3 to 7/4	v+h v+h v+h v+h	Ø115 (130) x 400 for motor up to 0.55 kW (1~) or up to 0.55 kW (3~) 1.5 kg	90 066 478	90 065 494 Ø115x117 0.3 kg	90 066 483 Set = 2 pcs. 0.6 kg
2/17 to 2/35 3/12 to 3/25 4/9 to 4/19 7/6 to 7/13 12/3 to 12/5	v+h v+h v+h v+h v+h	Ø115 (130) x 500 for motor up to 1.5 kW (1~) or up to 1.5 kW (3~) 1.8 kg	90 066 479		
2/40 to 2/72 3/30 to 3/51 4/24 to 4/39 7/16 to 7/26 12/8 to 12/10	v+h v+h v+h v+h v+h	Ø115 (130) x 620 for motor up to 2.2 kW (1~) or up to 3.0 kW (3~) 2.0 kg	90 066 480		
3/57 to 3/68 4/45 to 4/54 7/29 to 7/34 12/13 to 12/14	v+h v+h v+h v+h	Ø115 (130) x 800 for motor up to 4.0 kW (3~) 2.5 kg	90 066 481		
4/60 to 4/72 7/39 to 7/64 12/17 to 12/27	v+h v+h v+h	Ø115 (130) x 1000 for motor up to 7.5 kW (3~) 3.0 kg	90 066 482		90 066 484 Set = 2 pcs. 1.4 kg

Applications

Suitable for handling clean or slightly contaminated water in applications such as:

- domestic water supply
- general water supply
- irrigation and spray irrigation systems
- artificial lowering of the ground water level as well as
- heat transfer plants

In addition, the pump sets are used in pressure boosting systems, air-conditioning systems, fountains, etc.

Permissible sand content in the fluid handled: 50 g/m³.

Operating Data

Capacity	Q	up to 79 m ³ /h
Head	H	up to 570 m
Temperature of fluid handled .	t	up to 50 °C
Speed	n	2900 rpm

Design

Multistage centrifugal pump with components made of stainless steel and additional bearing for each stage. The stage casings are connected by means of tie bolts.

Motor

Canned or wet submersible squirrel-cage motor, 2 poles; NEMA shaft end; 50 Hz; type of enclosure: IP 68

Designation (Example)

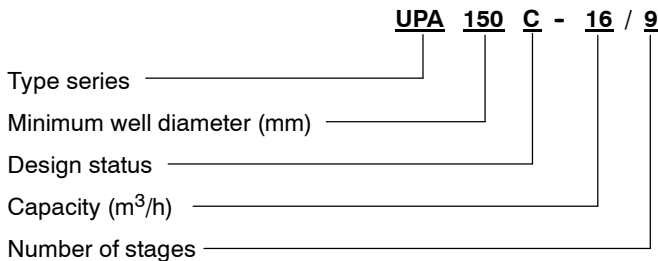

Certification

Quality management certified to ISO 9001



Product Features

- Rust-proof
- Suitable for installation in narrow deep wells
- High efficiency
- Motor designed for maximum pump output
- Low noise level
- For vertical, angled or horizontal installation
- Check valve with anti-blockage valve disc

Selection Charts (Ranges on Offer)

n ~ 2900 rpm

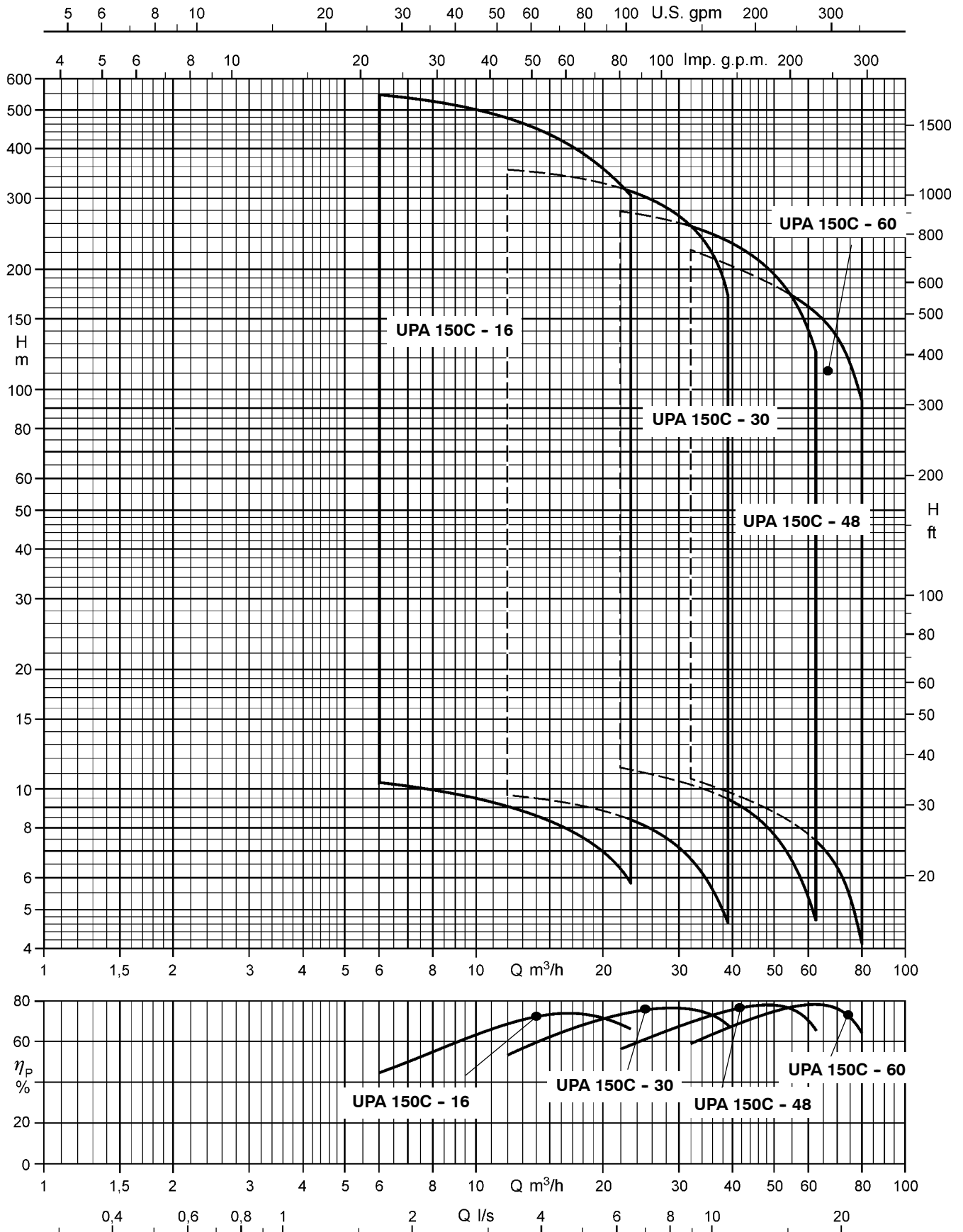

Material Variants

	Material	
	C1	C2
Pump		
Suction casing	1.4408	
Stage casing	1.4301	1.4404
Stage casing with hole	1.4301	1.4404
Upper stage casing	1.4301	1.4404
Suction strainer	1.4401	1.4404
Flanged end piece	1.4408	
Shaft	1.4305	1.4401
Impeller	1.4301	1.4404
Thrust bearing	HY22	
Counter thrust bearing	A2	A4
O-ring	NBR	
Casing wear ring	NBR	
Impeller wear ring	1.4301	1.4404
Bearing bush	NBR	
Disc	1.4301	1.4404
Valve body	1.4408	
Valve spring	1.4401	
Valve plate	1.4404	
Coupling	1.4308	1.4408
Tiebolt	1.4301	1.4404
Hexagon socket head screw	A2	A4
Hexagon socket head screw	A4	A4
Nut	A2	A4
Impeller nut	1.4401	
Locking sleeve	1.4401	
Clamp	1.4301	1.4404
Cable support	1.4301	1.4404
Protection plug	HY22	

		Material		
		G	C1	C2
Motor				
Shaft	DN 100	--	1.4305	1.4460
	UMA 150D	1.4305 ¹⁾ 1.4021 ²⁾	--	1.4462
Bearing carrier	DN 100	--	1.4301	1.4404
	UMA 150D	JL 1030	--	1.4409
Stator case	DN 100	--	1.4301	1.4571
	UMA 150D	1.4301	--	1.4571

¹⁾ only for UMA 150D ≤ 22/21

²⁾ only for UMA 150D > 22/21

Description

1.4301	CrNi steel
1.4305	CrNi steel
1.4308	CrNi steel
1.4401	CrNiMo steel
1.4404	CrNiMo steel
1.4408	CrNiMo steel
1.4462	CrNiMo steel
1.4571	CrNiMo steel
JL - 1030	cast iron
A2	CrNi steel
A4	CrNiMo steel

HY22	Carbon/graphite in PTFE
NBR	Acrylnitril-Butadien-Rubber

Bearings / Lubrication

Radial plain bearings: pump bearings lubricated by the fluid handled, motor bearings by the motor's water fill. Axial thrust is balanced by a tilting-pad thrust bearing in the motor (lower end).

Direction of Rotation of the Pump

Clockwise rotation (when looking at the drive shaft end).

Pump End (Discharge)

UPA 150C submersible borehole pumps can be supplied with the following discharge ends:

	G 2 1/2"	G 3"	G 4"	DN 50	DN 65	DN 80
UPA 150C - 16	x	x	-	x	x	x
UPA 150C - 30	-	x	x	-	x	x
UPA 150C - 48	-	x	x	-	x	x
UPA 150C - 60	-	x	x	-	x	x

Coating (Bearing carrier)

UMA 150D motor:

Quality powder coating, approved for drinking water contact
 Colour blue (RAL 5003)

Type of Installation

Standard vertical installation. Depending on the number of stages, horizontal installation is also possible.

Motor DN 100: In order to guarantee the dissipation of the motor heat it will be necessary to install a device guiding the flow along the motor (cooling jacket, flow inducer sleeve, etc.) in horizontal installation.

Drive

Design Canned¹⁾ or wet²⁾ submersible squirrel-cage motor, 2 poles
 Connection NEMA standard
 Type of enclosure IP 68
 Frequency f 50 Hz
 Type of current three-phase (3 ~)
 Rated voltage U up to 400V¹⁾ or 690 V²⁾
 Rated power P_N up to 37 kW
 Frequency of starts ... 20 / h¹⁾ and 15 / h²⁾
 Minimum delay before restarting 1 min¹⁾ or 2 min²⁾
 Motor design is in compliance with VDE regulations.

¹⁾ Motor DN 100

²⁾ Motor UMA 150D

Connection to Power Supply

The submersible motors are supplied ex factory with 1 or 2 motor leads, each equipped with an earth conductor. All motors are provided with internal earthing. Any extension cables required are connected using water-tight cable connectors. Motor leads and extension cables are suitable for drinking water applications.

Starting

Motor DN 100 d.o.l. only
 (autotransformer or soft starter)
 Motor UMA 150D . . . d.o.l. (autotransformer or soft starter)
 or star-delta

Variable Speed

The submersible borehole pumps can also be equipped with a speed control system to accommodate different operating points.

Application Temperatures

The submersible borehole pumps are, as a standard, suitable for use in water with temperatures of up to $t = + 30 \text{ }^\circ\text{C}$. An indispensable requirement for this is a flow velocity of $v = 0.2 \text{ m/s}$ past the motor. This requirement is met, for example, when the pump is installed in a deep well above the well screen / filter, etc.

With certain restrictions, some motor sizes may also be used in water with temperatures of up to $t = + 50 \text{ }^\circ\text{C}$ or for operation without an adequate cooling flow of water past the motor, i.e. $v = 0 \text{ m/s}$ (for example, when the unit is installed in a deep well below the screen / filter area or in a pump sump, etc.).

Variants Available on Request

- Other supply voltages up to 1000 V
- Pump sets for 1~ / 230 V up to 2.2 kW/50 Hz
 + 2.5 kW/60 Hz
- Models with cooling, suction or pressure shroud

Fluids handled

The data refer to the chemical resistance of the materials. The relevant regulations/standards governing individual pump applications have to be complied with. The actual operating conditions must always be checked. For operating conditions or fluids which are not listed in this table, always contact the manufacturer.

The fluid temperature must not exceed $50 \text{ }^\circ\text{C}$, unless stated otherwise.

Fluid handled	Spezifikation	Max. Temperature	material variant	
			C1	C2
Suspension	Water-sand mixture up to 20 mg/l		x	x
	Water-sand mixture up to 50 mg/l		x	x
	Water-sand mixture up to 200 mg/l		x	x
Demineralised water	De-ionised (fully desalinated) water		x	x
	De-alkalised water		x	x
	De-carbonised water		x	x
	Partly desalinated water		x	x
Fire-fighting water			x	x
Cooling water	Closed cooling circuit		x	x
	Open cooling circuit		x	x
Seawater and brackish water	Brackish water	$\leq 25 \text{ }^\circ\text{C}$		x
	Seawater	$\leq 25 \text{ }^\circ\text{C}$		x
Surface water	River water		x	x
	Lake water		x	x
	Dam water		x	x
Process water	Sealing water		x	x
	Flushing water		x	x
Storm water	With strainer		x	x
	Without strainer		x	x
Raw water			x	x
Dirty water	Slightly contaminated water		x	x
Swimming pool and bathing water	Seawater	$\leq 25 \text{ }^\circ\text{C}$		x
	Fresh water		x	x
Drinking / tap water	Brewing water		x	x
	Ice water (brewery)		x	x
	Tap water		x	x
	Clean water		x	x
	Warm water (brewery)		x	x

Design Features of the pump

Corrosion resistance

The pump and motor are constructed of high-grade stainless steel as standard - producing consistently high efficiency levels. Also available in higher grade CrNiMo steel for aggressive fluids.

Low operating costs

High efficiency and low-loss check valve maintain long-term energy savings over the entire service life-time of the unit.

Maintenance-friendly design

- Simple disassembly and reassembly
- Rewindable motors

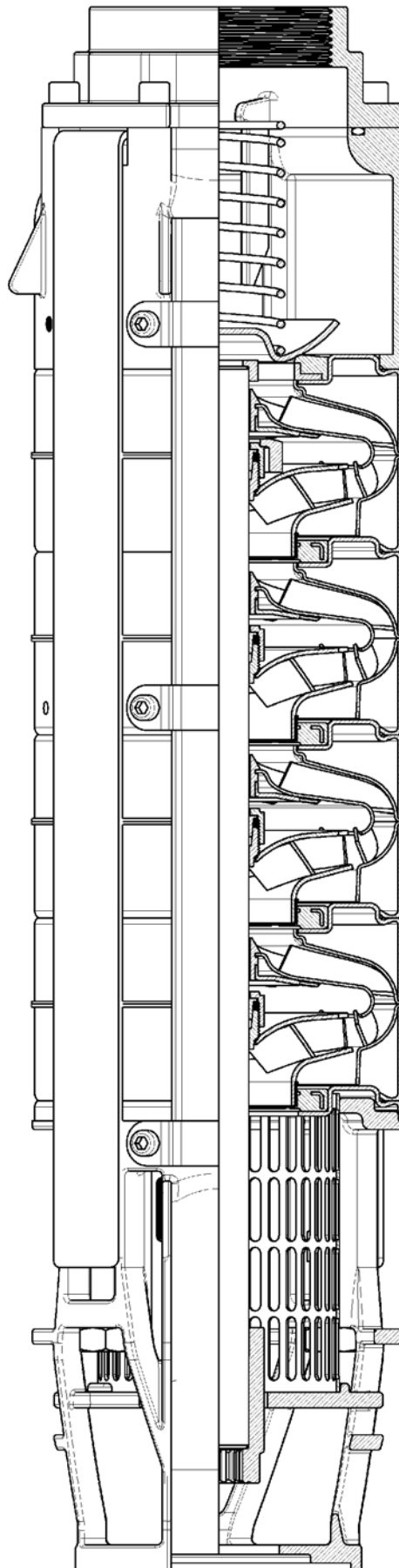

Flexibility

- Exchangeable connection variants
- Check valve can be removed easily
- Suitable for vertical installation in deep wells or horizontal installation
- NEMA connection

High operating reliability and long service life

Equipped with reinforced suction strainer, robust drive lantern and check valve made of investment cast stainless steel. Laser-welded impellers. Protected against thrust reversal.

Hygienic and approved for drinking water

ACS approved

Design Features of the motor UMA 150D

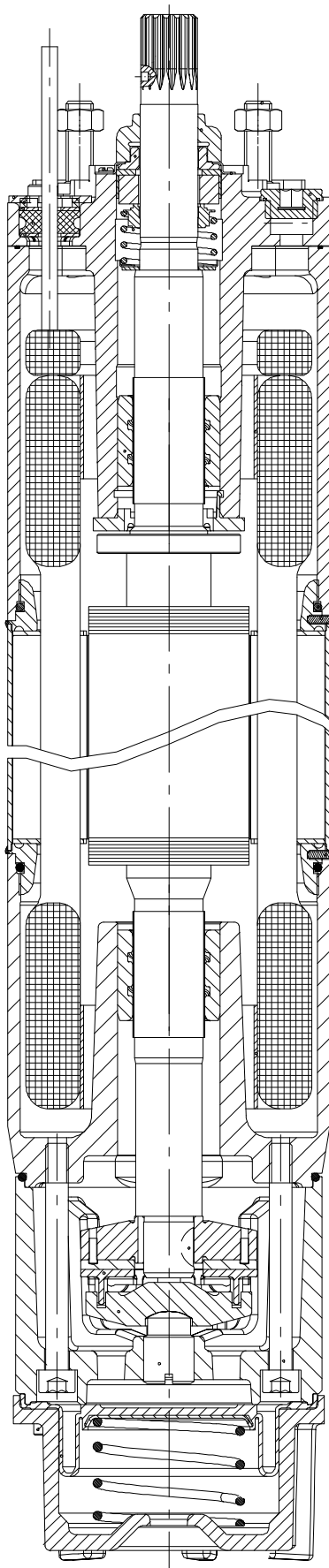

Counter thrust bearing

- Reliable balancing of negative axial thrust.
- Impellers do not rub on the stage casings.

Tried and tested thrust bearing

- Water-lubricated self-aligning tilting-pad journal bearing.
- No-maintenance design suitable for maximum load-carrying capacity under continuous operation conditions.
- New materials combination (stainless steel / carbon) for high safety factor.

The KSB motor

- VDE-compliant, i.e., high level of electrical safety.
- Designed for max. pump power to protect unit from overloads.

Dynamically balanced rotor

- Ensures smooth running.

UPA 150C - 16 for Well Diameters of 150 mm (6 inches) and above

Pumps with submersible motors for ... - Type of current / voltage **three-phase (3 ~) / 400 V**
 - Starting **d.o.l. (D) or star-delta (Y-Δ)**

UPA 150C - 16 / ...	Pump		Motor				Motor lead ²⁾ , flat	
	Discharge head Q = 0 m ³ /h	Rated power	Max. temperature of the fluid pumped v ≥ 0.2 m/s (0.0 m/s)	Rated current	Efficiency	Power factor	Number x cross-section of conductors (use under water, 400 V and ≤ +30 °C)	
	H ₀ m	P _N kW	t _{max} ¹⁾ °C	I _N A	η _M %	cos φ ---	d.o.l. mm ²	Y-Δ mm ²
1 + DN 100 - 0.75	11.2	0.75	30 (30)	2.1	70.0	0.76	4 x 1.5	-
2 + DN 100 - 1.5	22	1.5	30 (30)	3.9	73.0	0.77	4 x 1.5	-
3 + DN 100 - 2.2	32.5	2.2	30 (30)	6.2	75.0	0.75	4 x 1.5	-
4 + DN 100 - 3.0	44	3.0	30 (30)	8.0	76.0	0.76	4 x 1.5	-
5 + DN 100 - 3.0	54	3.0	30 (30)	8.0	76.0	0.76	4 x 1.5	-
6 + DN 100 - 3.7	65	3.7	30 (30)	9.2	77.5	0.80	4 x 1.5	-
7 + UMA 150D 5/21	80	4.5	42 (39)	12.0	76.5	0.74	4 x 2.5	3/4 x 2.5
7 + DN 100 - 5.5	79	5.5	30 (20)	13.0	76.5	0.80	4 x 1.5	-
8 + UMA 150D 5/21	91	5.0	40 (36)	12.7	76.0	0.78	4 x 2.5	3/4 x 2.5
8 + DN 100 - 5.5	90	5.5	30 (20)	13.0	76.5	0.80	4 x 1.5	-
9 + UMA 150D 5/21	102	5.5	37 (33)	13.6	75.5	0.80	4 x 2.5	3/4 x 2.5
9 + DN 100 - 5.5	100	5.5	30 (20)	13.0	76.5	0.80	4 x 1.5	-
10 + UMA 150D 7/21	113	6.5	38 (34)	16.0	77.5	0.79	4 x 2.5	3/4 x 2.5
10 + DN 100 - 7.5	110	7.5	30 (20)	18.4	74.0	0.79	4 x 1.5	-
11 + UMA 150D 7/21	124	7.0	35 (31)	16.8	77.0	0.81	4 x 2.5	3/4 x 2.5
11 + DN 100 - 7.5	121	7.5	30 (20)	18.4	74.0	0.79	4 x 1.5	-
12 + UMA 150D 7/21	134	7.5	33 (28)	17.8	76.5	0.82	4 x 2.5	3/4 x 2.5
12 + DN 100 - 7.5	131	7.5	30 (20)	18.4	74.0	0.79	4 x 1.5	-
13 + UMA 150D 7/21	145	7.5	30 (24)	17.8	76.5	0.82	4 x 2.5	3/4 x 2.5
13 + DN 100 - 7.5	140	7.5	30 (20)	18.4	74.0	0.79	4 x 1.5	-
14 + UMA 150D 9/21	157	8.5	33 (28)	20.0	78.5	0.81	4 x 2.5	3/4 x 2.5
15 + UMA 150D 9/21	168	9.0	31 (25)	20.5	78.0	0.82	4 x 2.5	3/4 x 2.5
16 + UMA 150D 9/21	178	9.3	28 (22)	21.0	77.5	0.83	4 x 2.5	3/4 x 2.5
17 + UMA 150D 13/21	193	10.5	36 (32)	25.0	81.0	0.76	4 x 2.5	3/4 x 2.5
18 + UMA 150D 13/21	204	11.0	35 (30)	25.5	80.5	0.78	4 x 2.5	3/4 x 2.5
19 + UMA 150D 13/21	215	11.5	33 (28)	26.5	80.5	0.79	4 x 2.5	3/4 x 2.5
20 + UMA 150D 13/21	225	12.0	32 (26)	27.0	80.5	0.80	4 x 2.5	3/4 x 2.5

¹⁾ also see page 36

²⁾ 3/4 = 1 x 3-core + 1 x 4-core, 90° spacing.

Dimensions / Weights / Horizontal Installation ¹⁾

UPA 150C - 16 / ...	L _p ≈ mm		L _A ≈ mm		m _A ≈ kg		D _{max} ≈ mm			Installation ²⁾
	for motor		incl. motor		incl. motor		d.o.l.	d.o.l.	Y-Δ	
	DN	UMA	DN	UMA	DN	UMA	DN	UMA	UMA	
1	337	--	619	--	17	--	139	--	--	v + h
2	397	--	734	--	20	--	139	--	--	v + h
3	458	--	825	--	23	--	139	--	--	v + h
4	518	--	950	--	27	--	139	--	--	v + h
5	579	--	1011	--	28	--	139	--	--	v + h
6	639	--	1201	--	36	--	139	--	--	v + h
7	700	731	1404	1399	44	63	139	142	142	v + h
8	760	760	1465	1459	46	66	139	142	142	v + h
9	821	821	1525	1520	47	67	139	142	142	v + h
10	881	913	1655	1632	52	70	139	142	142	v + h
11	942	973	1716	1692	53	72	139	142	142	v + h
12	1002	1034	1776	1753	55	73	139	142	142	v + h
13	1063	1094	1837	1813	56	74	139	142	142	v + h
14	--	1155	--	1904	--	79	--	142	142	v + h
15	--	1215	--	1964	--	80	--	142	142	v + h
16	--	1276	--	2025	--	81	--	142	142	v + h
17	--	1336	--	2165	--	90	--	142	142	v + h
18	--	1397	--	2226	--	91	--	142	142	v + h
19	--	1457	--	2286	--	93	--	142	142	v + h
20	--	1518	--	2347	--	94	--	142	142	v + h

¹⁾ Including check valve with threaded end and standard motor leads.

²⁾ v = vertical / h = horizontal.

UPA 150C - 16 / ..., number of stages 1 - 20

The characteristic curves shown are for preliminary selection only. Exact selection data will be provided in our quotation.

Selection

The pressure losses H_v in the check valve are not considered in the pump characteristic curves.

Legend ...

H_v : Head losses in the check valve

η_p : Pump efficiency (not considering check valve)

NPSH: Net positive suction head required by the pump

Pump End G 2 1/2"

The information given below is based on the model with check valve and threaded end.

The changes in the main dimensions resulting from different threaded or flanged ends are specified in the table below.

	Overall length (mm)	D_{max} (mm)
G 2 1/2"	40	see page 40
G 3"	48	
G 4"	93	
DN 50	77	165
DN 65	77	185
DN 80	77	200

Threaded end to DIN ISO 228, Part 1.
Flanged end to DIN 2501, Part 1

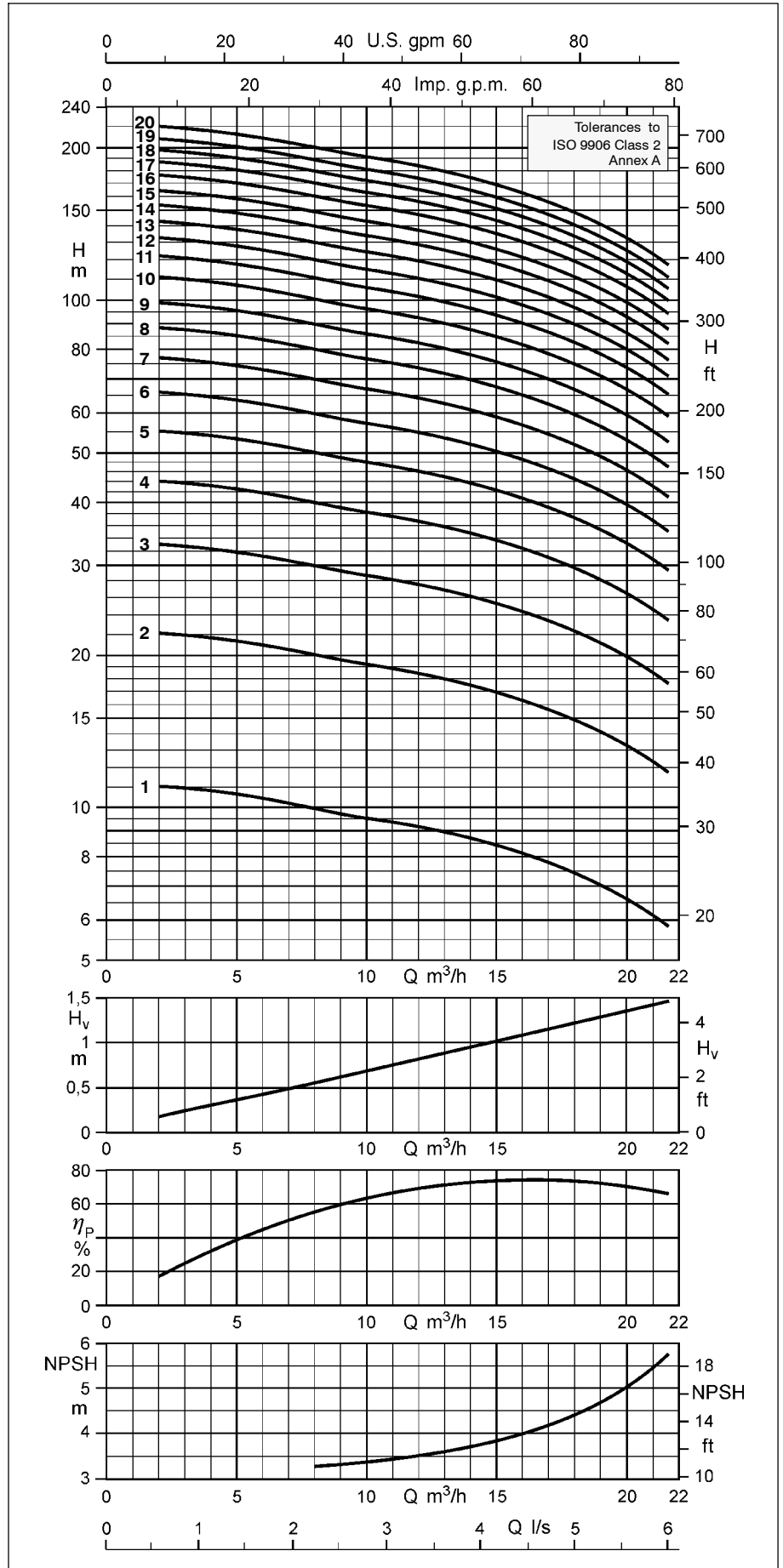
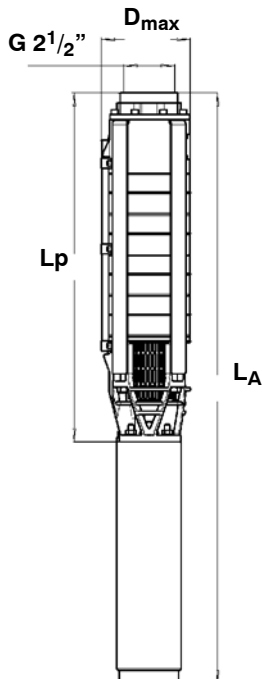

UPA 150C - 16 for Well Diameters of 150 mm (6 inches) and above

Pumps with submersible motors for ... - Type of current / voltage **three-phase (3 ~) / 400 V**
 - Starting **d.o.l. (D) or star-delta (Y-Δ)**

UPA 150C - 16 / ...	Pump	Motor					Motor lead ²⁾ , flat	
	Discharge head Q = 0 m ³ /h	Rated power	Max. temperature of the fluid pumped v ≥ 0.2 m/s (0.0 m/s)	Rated current	Efficiency	Power factor	Number x cross-section of conductors (use under water, 400 V and ≤ +30 °C)	
	H ₀ m	P _N kW	t _{max} ¹⁾ °C	I _N A	η _M %	cos φ ---	d.o.l. mm ²	Y-Δ mm ²
21 + UMA 150D 13/21	236	13.0	30 (24)	29.0	80.0	0.81	4 x 2.5	3/4 x 2.5
22 + UMA 150D 13/21	246	13.0	29 (22)	29.0	80.0	0.81	4 x 2.5	3/4 x 2.5
23 + UMA 150D 13/21	256	13.0	28 (22)	29.0	80.0	0.81	4 x 2.5	3/4 x 2.5
24 + UMA 150D 15/21	269	14.0	33 (28)	30.5	82.0	0.82	4 x 4.0	3/4 x 2.5
25 + UMA 150D 15/21	280	15.0	32 (26)	32.5	81.5	0.83	4 x 4.0	3/4 x 2.5
26 + UMA 150D 15/21	290	15.0	30 (25)	32.5	81.5	0.83	4 x 4.0	3/4 x 2.5
27 + UMA 150D 18/21	305	16.0	32 (27)	36.5	82.5	0.78	4 x 4.0	3/4 x 2.5
28 + UMA 150D 18/21	315	16.5	31 (25)	37.0	82.0	0.79	4 x 4.0	3/4 x 2.5
29 + UMA 150D 18/21	326	17.0	30 (24)	38.0	82.0	0.79	4 x 4.0	3/4 x 2.5
30 + UMA 150D 18/21	336	17.5	29 (22)	39.0	82.0	0.80	4 x 4.0	3/4 x 2.5
31 + UMA 150D 18/21	347	18.0	27 (21)	39.5	82.0	0.81	4 x 4.0	3/4 x 2.5
32 + UMA 150D 18/21	357	18.5	26 (19)	40.5	81.5	0.81	4 x 4.0	3/4 x 2.5
33 + UMA 150D 22/21	373	20.0	33 (28)	44.0	83.5	0.79	4 x 4.0	3/4 x 2.5
34 + UMA 150D 22/21	383	20.0	33 (27)	44.0	83.5	0.79	4 x 4.0	3/4 x 2.5
35 + UMA 150D 22/21	394	21.0	32 (26)	46.0	83.5	0.80	4 x 4.0	3/4 x 2.5
36 + UMA 150D 22/21	404	22.0	31 (25)	47.5	83.5	0.81	4 x 4.0	3/4 x 2.5
37 + UMA 150D 22/21	415	22.0	30 (24)	47.5	83.5	0.81	4 x 4.0	3/4 x 2.5
38 + UMA 150D 22/21	425	22.0	29 (23)	47.5	83.5	0.81	4 x 4.0	3/4 x 2.5
39 + UMA 150D 26/21	441	24.0	36 (31)	52.0	85.0	0.80	4 x 6.0	3/4 x 4.0
40 + UMA 150D 26/21	451	24.0	35 (30)	52.0	85.0	0.80	4 x 6.0	3/4 x 4.0
43 + UMA 150D 26/21	483	26.0	33 (27)	55.0	84.5	0.82	4 x 6.0	3/4 x 4.0
45 + UMA 150D 26/21	504	26.0	31 (26)	55.0	84.5	0.82	4 x 6.0	3/4 x 4.0
48 + UMA 150D 30/21	542	29.0	33 (27)	63.0	84.5	0.80	4 x 6.0	3/4 x 4.0
52 + UMA 150D 30/21	583	30.0	30 (24)	65.0	84.5	0.80	4 x 6.0	3/4 x 4.0

¹⁾ also see page 36 ²⁾ 3/4 = 1 x 3-core + 1 x 4-core, 90° spacing.

Dimensions / Weights / Horizontal Installation ¹⁾

UPA 150C - 16 / ...	L _P ≈ mm		L _A ≈ mm		m _A ≈ kg		D _{max} ≈ mm		Installation ²⁾
	for motor		incl. motor		incl. motor		d.o.l.	Y-Δ	
	UMA		UMA		UMA		UMA	UMA	
21	1578	2407	95	142	142	v + h			
22	1639	2468	97	142	142	v + h			
23	1699	2528	98	142	142	v + h			
24	1760	2634	103	142	142	v + h			
25	1820	2694	104	142	142	v + h			
26	1881	2755	105	142	142	v + h			
27	1941	2860	112	142	142	v + h			
28	2002	2921	113	142	142	v + h			
29	2062	2981	114	142	142	v + h			
30	2123	3042	116	142	142	v + h			
31	2183	3102	117	142	142	v + h			
32	2244	3163	118	142	142	v + h			
33	2304	3313	128	142	142	v + h			
34	2365	3374	129	142	142	v + h			
35	2425	3434	130	142	142	v + h			
36	2486	3495	132	142	142	v + h			
37	2546	3555	133	142	142	v + h			
38	2607	3616	135	142	142	v + h			
39	2667	3781	145	142	142	v + h			
40	2728	3842	146	142	142	v + h			
43	on request								
45									
48									
52									

¹⁾ Including check valve with threaded end and standard motor leads. ²⁾ v = vertical / h = horizontal.

UPA 150C - 16 / ..., number of stages 21 - 52

The characteristic curves shown are for preliminary selection only. Exact selection data will be provided in our quotation.

Selection

The pressure losses H_v in the check valve are not considered in the pump characteristic curves.

Legend ...

H_v : Head losses in the check valve

η_p : Pump efficiency (not considering check valve)

NPSH: Net positive suction head required by the pump

Pump End G 2 1/2"

The information given below is based on the model with check valve and threaded end.

The changes in the main dimensions resulting from different threaded or flanged ends are specified in the table below.

	Overall length (mm)	D_{max} (mm)
G 2 1/2"	40	see page 42
G 3"	48	
G 4"	93	
DN 50	77	165
DN 65	77	185
DN 80	77	200

Threaded end to DIN ISO 228, Part 1.
Flanged end to DIN 2501, Part 1

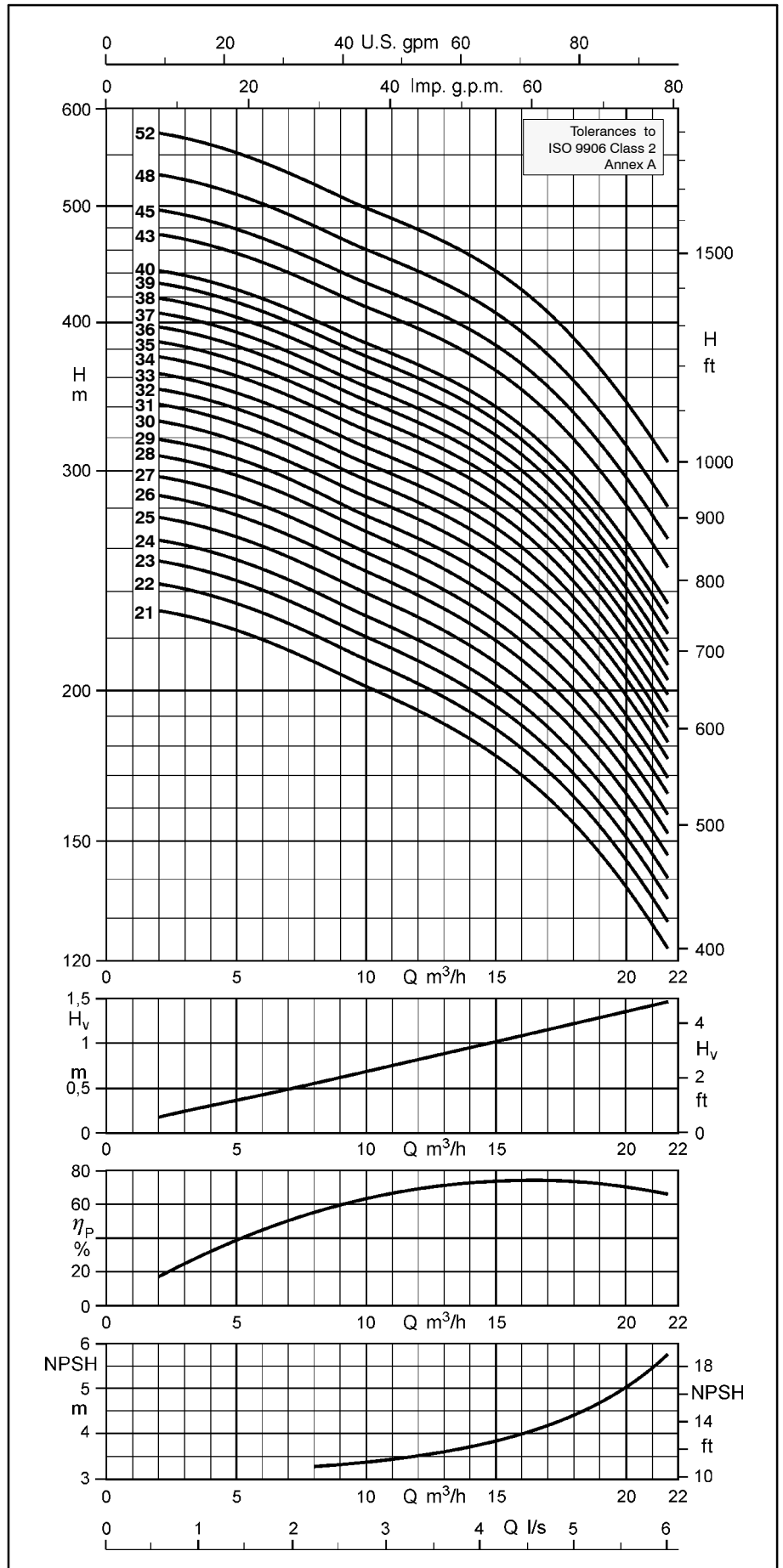
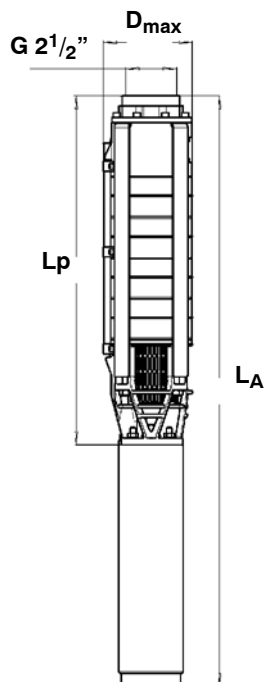

UPA 150C - 30 for Well Diameters of 150 mm (6 inches) and above

 Pumps with submersible motors for ... - Type of current / voltage **three-phase (3 ~) / 400 V**
 - Starting **d.o.l. (D) or star-delta (Y-Δ)**

UPA 150C - 30 / ...	Pump		Motor				Motor lead ²⁾ , flat		
	Discharge head Q = 0 m ³ /h	Rated power	Max. temperature of the fluid pumped v ≥ 0.2 m/s (0.0 m/s)		Rated current	Efficiency	Power factor	Number x cross-section of conductors (use under water, 400 V and ≤ +30 °C)	
	H ₀ m	P _N kW	t _{max} ¹⁾ °C		I _N A	η _M %	cos φ ---	d.o.l. mm ²	Y-Δ mm ²
1 + DN 100 - 1.1	10.6	1.1	30 (30)		3.1	73.5	0.71	4 x 1.5	-
2 + DN 100 - 2.2	21.5	2.2	30 (30)		6.2	75.0	0.75	4 x 1.5	-
3 + DN 100 - 3.0	32.0	3.0	30 (30)		8.0	76.0	0.76	4 x 1.5	-
4 + DN 100 - 3.7	43.0	3.7	30 (30)		9.2	77.5	0.80	4 x 1.5	-
5 + UMA 150D 5/21	56.0	4.5	41 (38)		12.0	76.5	0.74	4 x 2.5	3/4 x 2.5
5 + DN 100 - 5.5	55.0	5.5	30 (20)		13.0	76.5	0.80	4 x 1.5	-
6 + UMA 150D 5/21	67.0	5.5	37 (33)		13.6	75.5	0.80	4 x 2.5	3/4 x 2.5
6 + DN 100 - 5.5	66.0	5.5	30 (20)		13.0	76.5	0.80	4 x 1.5	-
7 + UMA 150D 7/21	78.0	6.5	37 (33)		16.0	77.5	0.79	4 x 2.5	3/4 x 2.5
7 + DN 100 - 7.5	76.0	7.5	30 (20)		18.4	74.0	0.79	4 x 1.5	-
8 + UMA 150D 7/21	88.0	7.0	33 (29)		16.8	77.0	0.81	4 x 2.5	3/4 x 2.5
9 + UMA 150D 9/21	100.0	8.0	35 (30)		19.0	78.5	0.80	4 x 2.5	3/4 x 2.5
10 + UMA 150D 9/21	110.0	9.0	31 (26)		20.5	78.0	0.82	4 x 2.5	3/4 x 2.5
11 + UMA 150D 9/21	120.0	9.3	28 (22)		21.0	77.5	0.83	4 x 2.5	3/4 x 2.5
12 + UMA 150D 13/21	134.0	11.0	35 (31)		25.5	80.5	0.78	4 x 2.5	3/4 x 2.5
13 + UMA 150D 13/21	144.0	11.5	33 (28)		26.5	80.5	0.79	4 x 2.5	3/4 x 2.5
14 + UMA 150D 13/21	154.0	12.5	31 (25)		28.0	80.5	0.80	4 x 2.5	3/4 x 2.5
15 + UMA 150D 13/21	165.0	13.0	29 (22)		29.0	80.0	0.81	4 x 2.5	3/4 x 2.5
16 + UMA 150D 15/21	176.0	14.5	33 (28)		31.5	82.0	0.82	4 x 4.0	3/4 x 2.5
17 + UMA 150D 15/21	186.0	15.0	31 (25)		32.5	81.5	0.83	4 x 4.0	3/4 x 2.5
18 + UMA 150D 18/21	200.0	16.0	32 (27)		36.5	82.5	0.78	4 x 4.0	3/4 x 2.5

¹⁾ also see page 36

²⁾ 3/4 = 1 x 3-core + 1 x 4-core, 90° spacing.

Dimensions / Weights / Horizontal Installation ¹⁾

UPA 150C - 30 / ...	L _p ≈ mm		L _A ≈ mm		m _A ≈ kg		D _{max} ≈ mm			Installation ²⁾
	for motor		incl. motor		incl. motor		d.o.l.	d.o.l.	Y-Δ	
	DN	UMA	DN	UMA	DN	UMA	DN	UMA	UMA	
1	389	--	690	--	18	--	139	--	--	v + h
2	485	--	840	--	23	--	139	--	--	v + h
3	581	--	1005	--	27	--	139	--	--	v + h
4	677	--	1235	--	36	--	139	--	--	v + h
5	773	805	1478	1505	44	63	139	146	148	v + h
6	869	901	1574	1600	46	65	139	146	148	v + h
7	965	997	1739	1715	51	68	139	146	148	v + h
8	--	1093	--	1810	--	70	--	146	148	v + h
9	--	1189	--	1940	--	74	--	146	148	v + h
10	--	1285	--	2035	--	76	--	146	148	v + h
11	--	1381	--	2130	--	77	--	146	148	v + h
12	--	1477	--	2305	--	86	--	146	148	v + h
13	--	1573	--	2400	--	88	--	146	148	v + h
14	--	1669	--	2500	--	89	--	146	148	v + h
15	--	1765	--	2595	--	91	--	146	148	v + h
16	--	1861	--	2735	--	96	--	147	148	v + h
17	--	1957	--	2830	--	98	--	147	148	v + h
18	--	2053	--	2970	--	104	--	147	148	v + h

¹⁾ Including check valve with threaded end and standard motor leads.

²⁾ v = vertical / h = horizontal.

UPA 150C - 30 / ..., number of stages 1 - 18

The characteristic curves shown are for preliminary selection only. Exact selection data will be provided in our quotation.

Selection

The pressure losses H_v in the check valve are not considered in the pump characteristic curves.

Legend ...

H_v : Head losses in the check valve

η_p : Pump efficiency (not considering check valve)

NPSH: Net positive suction head required by the pump

Pump End G 3"

The information given below is based on the model with check valve and threaded end.

The changes in the main dimensions resulting from different threaded or flanged ends are specified in the table below.

	Overall length (mm)	D_{max} (mm)
G 3"	48	see page 44
G 4"	93	
DN 65	77	185
DN 80	77	200

Threaded end to DIN ISO 228, Part 1.
Flanged end to DIN 2501, Part 1

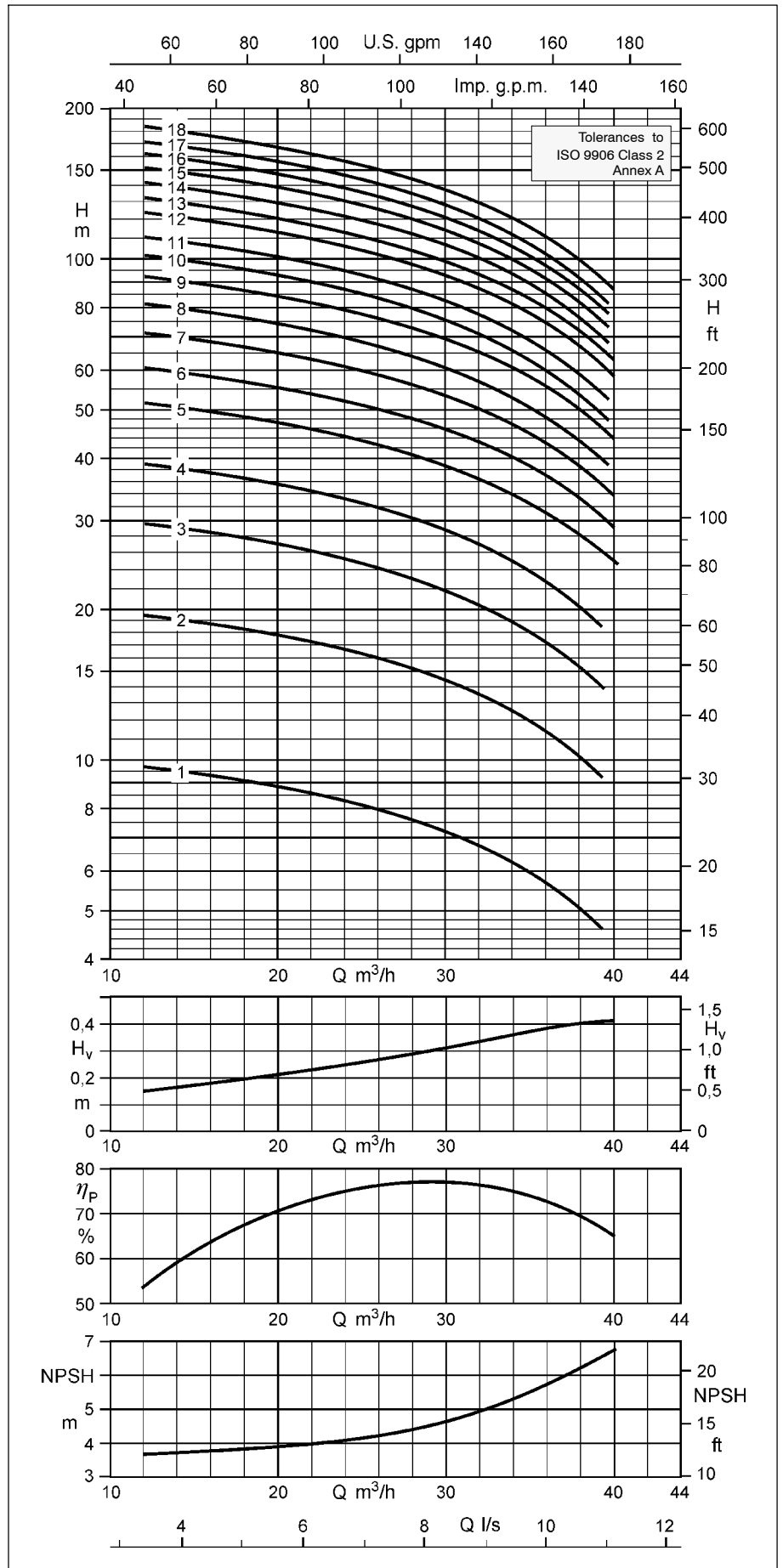
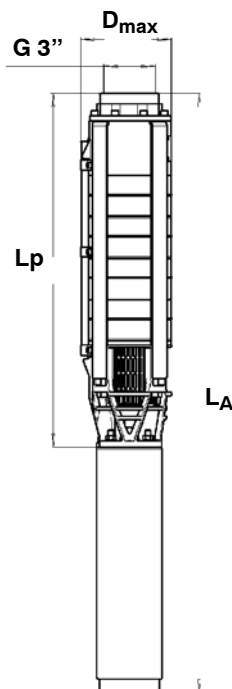

UPA 150C - 30 for Well Diameters of 150 mm (6 inches) and above

 Pumps with submersible motors for ... - Type of current / voltage **three-phase (3 ~) / 400 V**
 - Starting **d.o.l. (D) or star-delta (Y-Δ)**

UPA 150C - 30 / ...	Pump	Motor					Motor lead ²⁾ , flat	
	Discharge head Q = 0 m ³ /h	Rated power	Max. temperature of the fluid pumped v ≥ 0.2 m/s (0.0 m/s)	Rated current	Efficiency	Power factor	Number x cross-section of conductors (use under water, 400 V and ≤ +30 °C)	
	H ₀ m	P _N kW	t _{max} ¹⁾ °C	I _N A	η _M %	cos φ ---	d.o.l. mm ²	Y-Δ mm ²
19 + UMA 150D 18/21	210.0	17.0	30 (24)	38.0	82.0	0.79	4 x 4.0	3/4 x 2.5
20 + UMA 150D 18/21	220.0	18.0	29 (22)	39.5	82.0	0.81	4 x 4.0	3/4 x 2.5
21 + UMA 150D 18/21	230.0	18.5	27 (20)	40.5	81.5	0.81	4 x 4.0	3/4 x 2.5
22 + UMA 150D 22/21	244.0	20.0	33 (28)	44.0	83.5	0.79	4 x 4.0	3/4 x 2.5
23 + UMA 150D 22/21	254.0	21.0	32 (26)	46.0	83.5	0.80	4 x 4.0	3/4 x 2.5
24 + UMA 150D 22/21	265.0	22.0	31 (25)	47.5	83.5	0.81	4 x 4.0	3/4 x 2.5
25 + UMA 150D 22/21	275.0	22.0	29 (23)	47.5	83.5	0.81	4 x 4.0	3/4 x 2.5
26 + UMA 150D 26/21	289.0	24.0	36 (31)	52.0	85.0	0.80	4 x 6.0	3/4 x 4.0
27 + UMA 150D 26/21	299.0	24.0	35 (30)	52.0	85.0	0.80	4 x 6.0	3/4 x 4.0
28 + UMA 150D 26/21	309.0	25.0	34 (28)	53.0	85.0	0.81	4 x 6.0	3/4 x 4.0
29 + UMA 150D 26/21	320.0	26.0	32 (27)	55.0	84.5	0.82	4 x 6.0	3/4 x 4.0
30 + UMA 150D 26/21	330.0	26.0	31 (26)	55.0	84.5	0.82	4 x 6.0	3/4 x 4.0
31 + UMA 150D 30/21	345.0	28.0	34 (28)	61.0	84.5	0.79	4 x 6.0	3/4 x 4.0
32 + UMA 150D 30/21	355.0	29.0	33 (27)	63.0	84.5	0.80	4 x 6.0	3/4 x 4.0
33 + UMA 150D 30/21	365.0	30.0	32 (26)	65.0	84.5	0.80	4 x 6.0	3/4 x 4.0
34 + UMA 150D 30/21	376.0	30.0	31 (25)	65.0	84.5	0.80	4 x 6.0	3/4 x 4.0
35 + UMA 150D 37/22	389.0	32.0	46 (41)	71.0	84.0	0.78	3/4 x 4.0 ³⁾	3/4 x 4.0

¹⁾ also see page 36

²⁾ 3/4 = 1 x 3-core + 1 x 4-core, 90° spacing.

³⁾ Parallel cable

Dimensions / Weights / Horizontal Installation ¹⁾

UPA 150C - 30 / ...	L _p ≈ mm	L _A ≈ mm	m _A ≈ kg	D _{max} ≈ mm		Installation ²⁾
	for motor	incl. motor	incl. motor	d.o.l.	Y-Δ	
	UMA	UMA	UMA	UMA	UMA	
19	2149	3070	105	147	148	v ³⁾
20	2245	3165	107	147	148	v ³⁾
21	2341	3260	108	147	148	v ³⁾
22	2437	3445	118	147	148	v ³⁾
23	2533	3540	119	147	148	v ³⁾
24	2629	3640	121	147	148	v ³⁾
25	2725	3735	123	147	148	v ³⁾
26	2821	3935	133	149	149	v ³⁾
27	2917	4030	135	149	149	v ³⁾
28	3013	4125	136	149	149	v ³⁾
29	3109	4225	138	149	149	v ³⁾
30	3205	4320	140	149	149	v ³⁾
31	3301	4515	150	149	149	v ³⁾
32	3397	4610	152	149	149	v ³⁾
33	3493	4705	153	149	149	v ³⁾
34	3589	4805	155	149	149	v ³⁾

¹⁾ Including check valve with threaded end and standard motor leads.

²⁾ v = vertical / h = horizontal.

³⁾ Horizontal installation on request

UPA 150C - 30 / ..., number of stages 19 - 35

The characteristic curves shown are for preliminary selection only. Exact selection data will be provided in our quotation.

Selection

The pressure losses H_v in the check valve are not considered in the pump characteristic curves.

Legend ...

H_v : Head losses in the check valve

η_p : Pump efficiency (not considering check valve)

NPSH: Net positive suction head required by the pump

Pump End G 3"

The information given below is based on the model with check valve and threaded end.

The changes in the main dimensions resulting from different threaded or flanged ends are specified in the table below.

	Overall length (mm)	D_{max} (mm)
G 3"	48	see page 46
G 4"	93	
DN 65	77	185
DN 80	77	200

Threaded end to DIN ISO 228, Part 1.
Flanged end to DIN 2501, Part 1

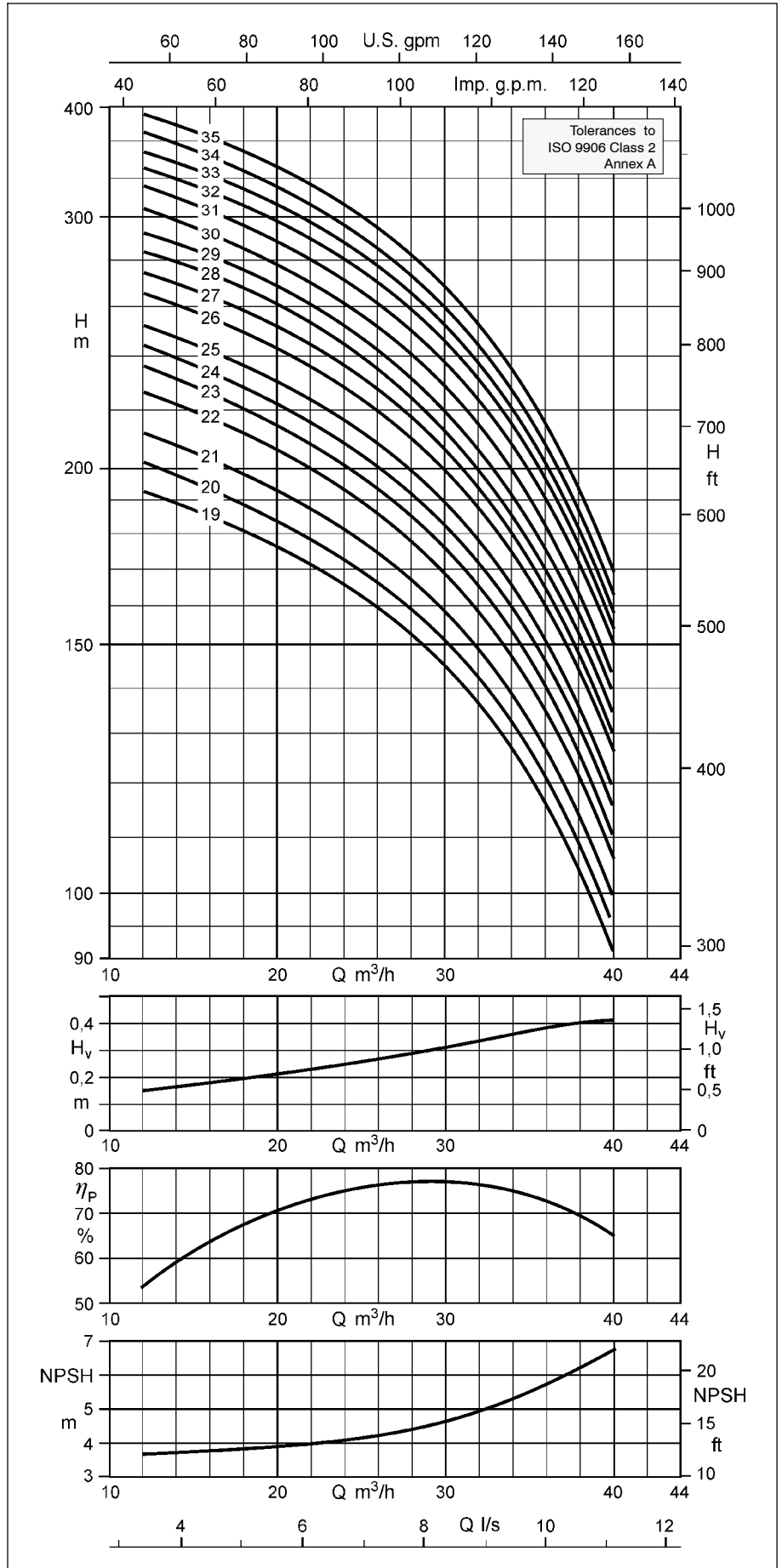
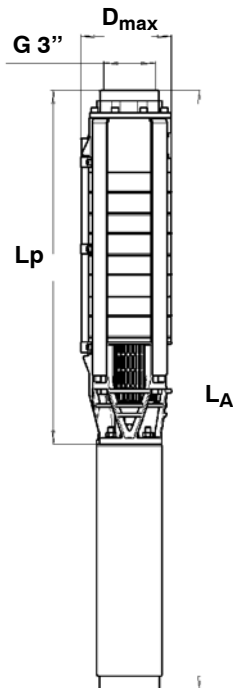

UPA 150C - 48 for Well Diameters of 150 mm (6 inches) and above

 Pumps with submersible motors for ... - Type of current / voltage **three-phase (3 ~) / 400 V**
 - Starting **d.o.l. (D) or star-delta (Y-Δ)**

UPA 150C - 48 / ...	Pump		Motor				Motor lead ²⁾ , flat		
	Discharge head Q = 0 m ³ /h	Rated power	Max. temperature of the fluid pumped v ≥ 0.2 m/s (0.0 m/s)		Rated current	Efficiency	Power factor	Number x cross-section of conductors (use under water, 400 V and ≤ +30 °C)	
	H ₀ m	P _N kW	t _{max} ¹⁾ °C		I _N A	η _M %	cos φ ---	d.o.l. mm ²	Y-Δ mm ²
1 + DN 100 - 2.2	13.2	2.2	30 (30)		6.2	75.0	0.75	4 x 1.5	-
2 + DN 100 - 3.0	26.5	3.0	30 (30)		8.0	76.0	0.76	4 x 1.5	-
3 + UMA 150D 5/21	42.0	5.0	40 (36)		12.7	76.0	0.78	4 x 2.5	3/4 x 2.5
3 + DN 100 - 5.5	41.0	5.5	30 (20)		13.0	76.5	0.80	4 x 1.5	-
4 + UMA 150D 7/21	55.0	6.5	37 (32)		16.0	77.5	0.79	4 x 2.5	3/4 x 2.5
4 + DN 100 - 7.5	54.0	7.5	30 (20)		18.4	74.0	0.79	4 x 1.5	-
5 + UMA 150D 9/21	69.0	8.0	35 (30)		19.0	78.5	0.80	4 x 2.5	3/4 x 2.5
6 + UMA 150D 9/21	81.0	9.3	29 (23)		21.0	77.5	0.83	4 x 2.5	3/4 x 2.5
7 + UMA 150D 13/21	97.0	11.5	34 (29)		26.5	80.5	0.79	4 x 2.5	3/4 x 2.5
8 + UMA 150D 13/21	109.0	12.5	30 (25)		28.0	80.5	0.80	4 x 2.5	3/4 x 2.5
9 + UMA 150D 15/21	123.0	14.5	33 (28)		31.5	82.0	0.82	4 x 4.0	3/4 x 2.5
10 + UMA 150D 18/21	138.0	16.0	32 (27)		36.5	82.5	0.78	4 x 4.0	3/4 x 2.5
11 + UMA 150D 18/21	151.0	17.5	29 (23)		39.0	82.0	0.80	4 x 4.0	3/4 x 2.5
12 + UMA 150D 18/21	163.0	18.5	26 (19)		40.5	81.5	0.81	4 x 4.0	3/4 x 2.5
13 + UMA 150D 22/21	179.0	21.0	32 (26)		46.0	83.5	0.80	4 x 4.0	3/4 x 2.5
14 + UMA 150D 22/21	191.0	22.0	29 (23)		47.5	83.5	0.81	4 x 4.0	3/4 x 2.5

1) also see page 36

2) 3/4 = 1 x 3-core + 1 x 4-core, 90° spacing.

Dimensions / Weights / Horizontal Installation ¹⁾

UPA 150C - 48 / ...	L _p ≈ mm		L _A ≈ mm		m _A ≈ kg		D _{max} ≈ mm			Installation ²⁾
	for motor		incl. motor		incl. motor		d.o.l.	d.o.l.	Y-Δ	
	DN	UMA	DN	UMA	DN	UMA	DN	UMA	UMA	
1	406	--	765	--	23.0	--	139	--	--	v + h
2	519	--	945	--	29.1	--	139	--	--	v + h
3	632	664	1337	1365	43.0	63.3	139	143	146	v + h
4	745	777	1519	1500	49.2	67.6	139	143	146	v + h
5	--	890	--	1640	--	72.9	--	143	146	v + h
6	--	1003	--	1755	--	75.1	--	143	146	v + h
7	--	1116	--	1945	--	84.4	--	143	146	v + h
8	--	1229	--	2060	--	86.7	--	143	146	v + h
9	--	1342	--	2220	--	92.9	--	145	146	v + h
10	--	1455	--	2375	--	99.2	--	145	146	v + h
11	--	1568	--	2490	--	101.5	--	145	146	v + h
12	--	1681	--	2600	--	103.7	--	145	146	v + h
13	--	1794	--	2805	--	114.0	--	145	146	v + h
14	--	1907	--	2920	--	116.3	--	145	146	v + h

1) Including check valve with threaded end and standard motor leads.

2) v = vertical / h = horizontal.

UPA 150C - 48 / ..., number of stages 1 - 14

The characteristic curves shown are for preliminary selection only. Exact selection data will be provided in our quotation.

Selection

The pressure losses H_v in the check valve are not considered in the pump characteristic curves.

Legend ...

H_v : Head losses in the check valve

η_p : Pump efficiency (not considering check valve)

NPSH: Net positive suction head required by the pump

Pump End G 3"

The information given below is based on the model with check valve and threaded end.

The changes in the main dimensions resulting from different threaded or flanged ends are specified in the table below.

	Overall length (mm)	D_{max} (mm)
G 3"	48	see page 48
G 4"	93	see page 48
DN 80	77	200

Threaded end to DIN ISO 228, Part 1.
Flanged end to DIN 2501, Part 1

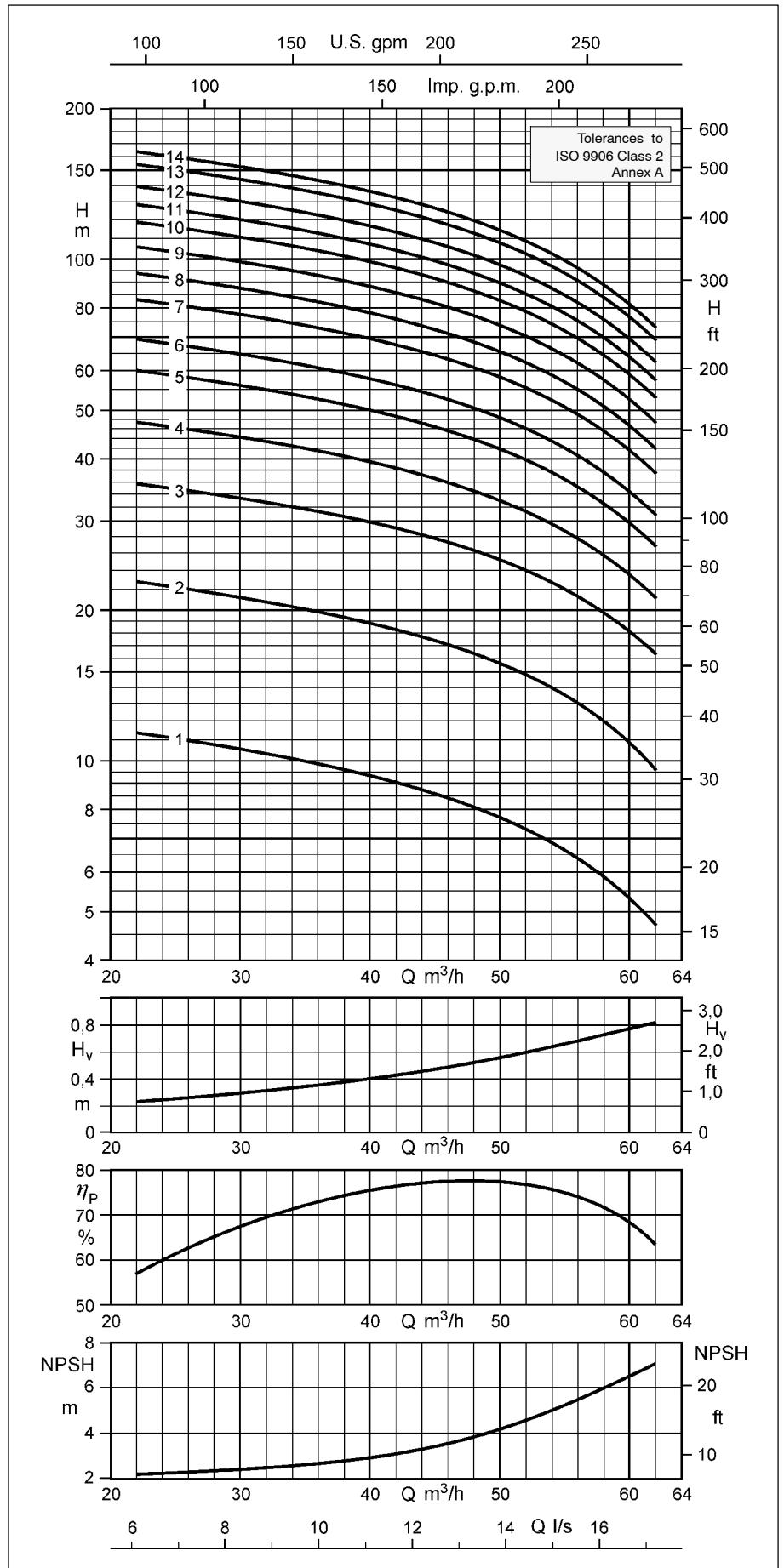
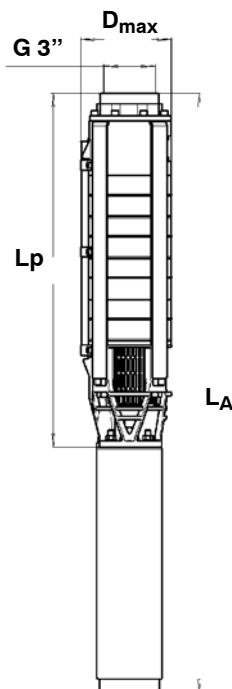

UPA 150C - 48 for Well Diameters of 150 mm (6 inches) and above

 Pumps with submersible motors for ... - Type of current / voltage **three-phase (3 ~) / 400 V**
 - Starting **d.o.l. (D) or star-delta (Y-Δ)**

UPA 150C - 48 / ...	Pump	Motor					Motor lead ²⁾ , flat	
	Discharge head Q = 0 m ³ /h	Rated power	Max. temperature of the fluid pumped v ≥ 0.2 m/s (0.0 m/s)	Rated current	Efficiency	Power factor	Number x cross-section of conductors (use under water, 400 V and ≤ +30 °C)	
	H ₀ m	P _N kW	t _{max} ¹⁾ °C	I _N A	η _M %	cos φ ---	d.o.l. mm ²	Y-Δ mm ²
15 + UMA 150D 26/21	207.0	24.0	35 (30)	52.0	85.0	0.80	4 x 6.0	3/4 x 4.0
16 + UMA 150D 26/21	219.0	26.0	33 (28)	55.0	84.5	0.82	4 x 6.0	3/4 x 4.0
17 + UMA 150D 26/21	232.0	26.0	31 (25)	55.0	84.5	0.82	4 x 6.0	3/4 x 4.0
18 + UMA 150D 30/21	248.0	29.0	33 (27)	63.0	84.5	0.80	4 x 6.0	3/4 x 4.0
19 + UMA 150D 30/21	261.0	30.0	31 (25)	65.0	84.5	0.80	4 x 6.0	3/4 x 4.0
20 + UMA 150D 37/22	276.0	32.0	45 (40)	71.0	84.0	0.78	3/4 x 4.0 ³⁾	3/4 x 4.0
21 + UMA 150D 37/22	289.0	33.0	44 (38)	72.0	84.0	0.79	3/4 x 4.0 ³⁾	3/4 x 4.0
22 + UMA 150D 37/22	301.0	35.0	42 (36)	76.0	84.0	0.80	3/4 x 4.0 ³⁾	3/4 x 4.0
23 + UMA 150D 37/22	314.0	36.0	41 (35)	77.0	83.5	0.81	3/4 x 4.0 ³⁾	3/4 x 4.0
24 + UMA 150D 37/22	327.0	37.0	39 (33)	79.0	83.5	0.82	3/4 x 4.0 ³⁾	3/4 x 4.0

¹⁾ also see page 36

²⁾ 3/4 = 1 x 3-core + 1 x 4-core, 90° spacing.

³⁾ Parallel cable

Dimensions / Weights / Horizontal Installation ¹⁾

UPA 150C - 48 / ...	L _p ≈ mm	L _A ≈ mm	m _A ≈ kg	D _{max} ≈ mm		Installation ²⁾
	for motor	incl. motor	incl. motor	d.o.l.	Y-Δ	
	UMA	UMA	UMA	UMA	UMA	
15	2020	3135	128.0	146	147	v ³⁾
16	2133	3250	130.0	146	147	v ³⁾
17	2246	3360	132.0	146	147	v ³⁾
18	2359	3575	143.0	146	147	v ³⁾
19	2472	3690	146.0	146	147	v ³⁾
20	2585	3880	155.0	145	147	v ³⁾
21	2698	3995	157.0	145	147	v ³⁾
22	2811	4105	159.0	145	147	v ³⁾
23	2924	4220	162.0	145	147	v ³⁾
24	3037	4335	164.0	145	147	v ³⁾

¹⁾ Including check valve with threaded end and standard motor leads.

²⁾ v = vertical / h = horizontal.

³⁾ Horizontal installation on request

UPA 150C - 48 / ..., number of stages 15 - 24

The characteristic curves shown are for preliminary selection only. Exact selection data will be provided in our quotation.

Selection

The pressure losses H_v in the check valve are not considered in the pump characteristic curves.

Legend ...

H_v : Head losses in the check valve

η_p : Pump efficiency (not considering check valve)

NPSH: Net positive suction head required by the pump

Pump End G 3"

The information given below is based on the model with check valve and threaded end.

The changes in the main dimensions resulting from different threaded or flanged ends are specified in the table below.

	Overall length (mm)	D_{max} (mm)
G 3"	48	see page 50
G 4"	93	
DN 80	77	200

Threaded end to DIN ISO 228, Part 1.
Flanged end to DIN 2501, Part 1

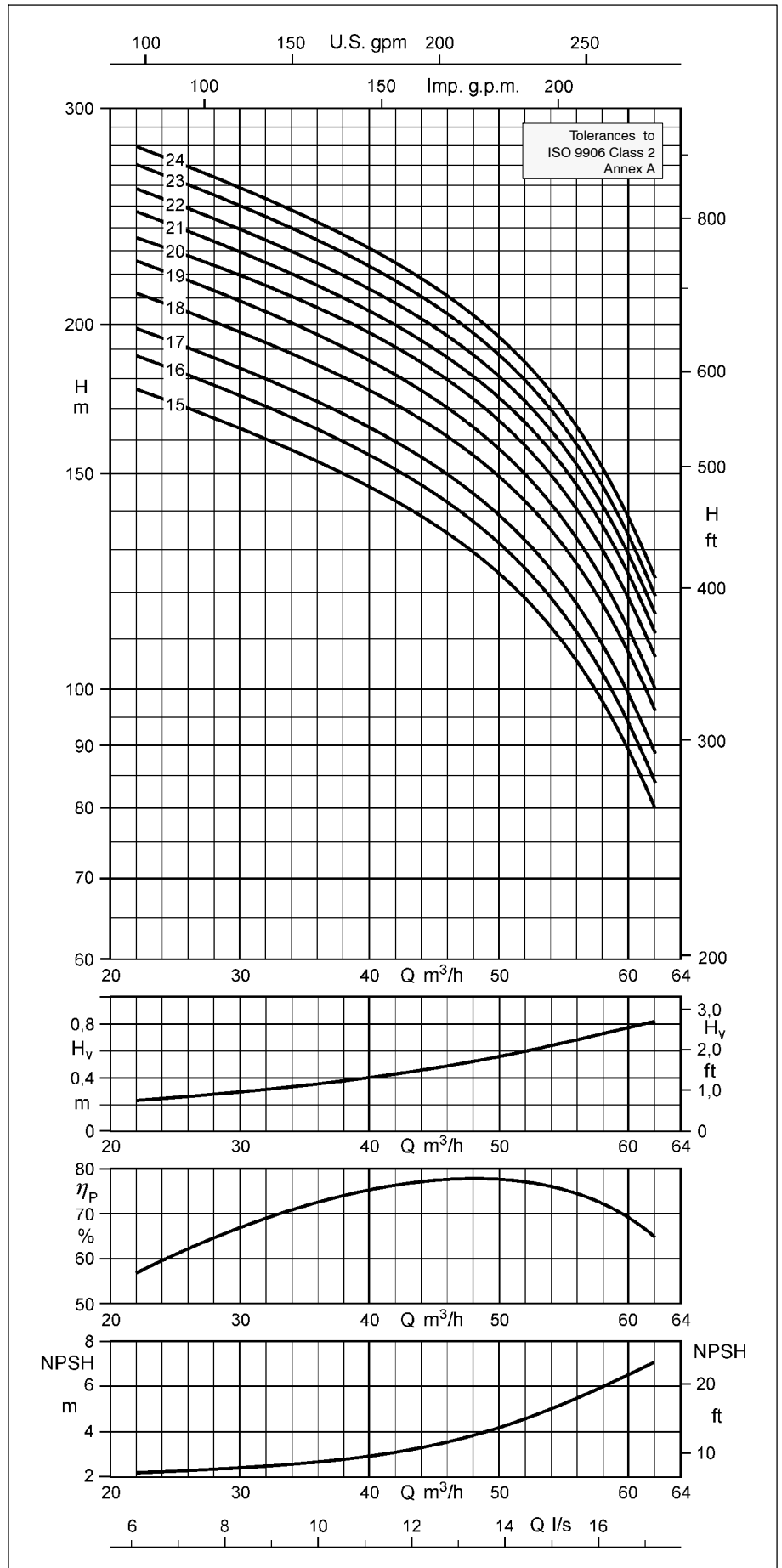
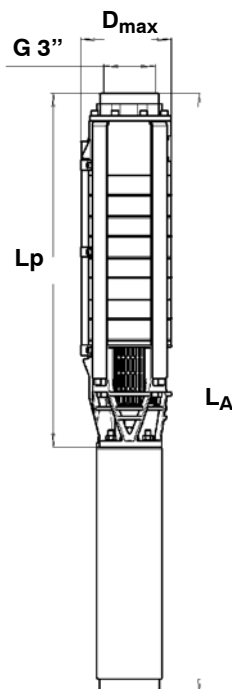

UPA 150C - 60 for Well Diameters of 150 mm (6 inches) and above

 Pumps with submersible motors for ... - Type of current / voltage **three-phase (3 ~) / 400 V**
 - Starting **d.o.l. (D) or star-delta (Y-Δ)**

UPA 150C - 60 / ...	Pump	Motor					Motor lead ²⁾ , flat	
	Discharge head Q = 0 m ³ /h	Rated power	Max. temperature of the fluid pumped v ≥ 0.2 m/s (0.0 m/s)	Rated current	Efficiency	Power factor	Number x cross-section of conductors (use under water, 400 V and ≤ +30 °C)	
	H ₀ m	P _N kW	t _{max} ¹⁾ °C	I _N A	η _M %	cos φ ---	d.o.l. mm ²	Y-Δ mm ²
1 + DN 100 - 2.2	13.4	2.2	30 (30)	6.2	75.0	0.75	4 x 1.5	-
2 + DN 100 - 3.7	27.0	3.7	30 (30)	9.2	77.5	0.80	4 x 1.5	-
3 + UMA 150D 7/21	42.0	6.0	39 (35)	15.1	77.5	0.77	4 x 2.5	3/4 x 2.5
3 + DN 100 - 7.5	41.0	7.5	30 (20)	18.4	74.0	0.79	4 x 1.5	-
4 + UMA 150D 7/21	55.0	7.5	31 (26)	17.8	76.5	0.82	4 x 2.5	3/4 x 2.5
4 + DN 100 - 7.5	53.0	7.5	30 (20)	18.4	74.0	0.79	4 x 1.5	-
5 + UMA 150D 9/21	69.0	9.3	29 (23)	21.0	77.5	0.83	4 x 2.5	3/4 x 2.5
6 + UMA 150D 13/21	84.0	11.5	33 (28)	26.5	80.5	0.79	4 x 2.5	3/4 x 2.5
7 + UMA 150D 13/21	97.0	13.0	28 (22)	29.0	80.0	0.81	4 x 2.5	3/4 x 2.5
8 + UMA 150D 15/21	111.0	15.0	31 (25)	32.5	81.5	0.83	4 x 4.0	3/4 x 2.5
9 + UMA 150D 18/21	125.0	17.5	30 (24)	39.0	82.0	0.80	4 x 4.0	3/4 x 2.5
10 + UMA 150D 22/21	140.0	20.0	34 (29)	44.0	83.5	0.79	4 x 4.0	3/4 x 2.5
11 + UMA 150D 22/21	153.0	21.0	31 (25)	46.0	83.5	0.80	4 x 4.0	3/4 x 2.5
12 + UMA 150D 26/21	168.0	23.0	36 (31)	49.5	85.0	0.79	4 x 6.0	3/4 x 4.0
13 + UMA 150D 26/21	181.0	25.0	34 (28)	53.0	85.0	0.81	4 x 6.0	3/4 x 4.0

¹⁾ also see page 36

²⁾ 3/4 = 1 x 3-core + 1 x 4-core, 90° spacing.

Dimensions / Weights / Horizontal Installation ¹⁾

UPA 150C - 60 / ...	L _P ≈ mm		L _A ≈ mm		m _A ≈ kg		D _{max} ≈ mm			Installation ²⁾
	for motor		incl. motor		incl. motor		d.o.l.	d.o.l.	Y-Δ	
	DN	UMA	DN	UMA	DN	UMA	DN	UMA	UMA	
1	406	--	765	--	22.9	--	139	--	--	v + h
2	519	--	1075	--	36.5	--	139	--	--	v + h
3	632	664	1406	1385	46.8	65.2	139	143	146	v + h
4	745	777	1519	1495	49.1	67.5	139	143	146	v + h
5	--	890	--	1640	--	72.8	--	143	146	v + h
6	--	1003	--	1830	--	82.0	--	143	146	v + h
7	--	1116	--	1945	--	84.3	--	143	146	v + h
8	--	1229	--	2105	--	90.6	--	145	146	v + h
9	--	1342	--	2260	--	96.8	--	145	146	v + h
10	--	1455	--	2465	--	107.1	--	145	146	v + h
11	--	1568	--	2575	--	109.4	--	145	146	v + h
12	--	1681	--	2795	--	120.6	--	146	147	v + h
13	--	1794	--	2910	--	122.9	--	146	147	v + h

¹⁾ Including check valve with threaded end and standard motor leads.

²⁾ v = vertical / h = horizontal.

UPA 150C - 60 / ..., number of stages 1 - 13

The characteristic curves shown are for preliminary selection only. Exact selection data will be provided in our quotation.

Selection

The pressure losses H_v in the check valve are not considered in the pump characteristic curves.

Legend ...

H_v : Head losses in the check valve

η_p : Pump efficiency (not considering check valve)

NPSH: Net positive suction head required by the pump

Pump End G 3"

The information given below is based on the model with check valve and threaded end.

The changes in the main dimensions resulting from different threaded or flanged ends are specified in the table below.

	Overall length (mm)	D_{max} (mm)
G 3"	48	see page 52
G 4"	93	

Threaded end to DIN ISO 228, Part 1.
Flanged end to DIN 2501, Part 1

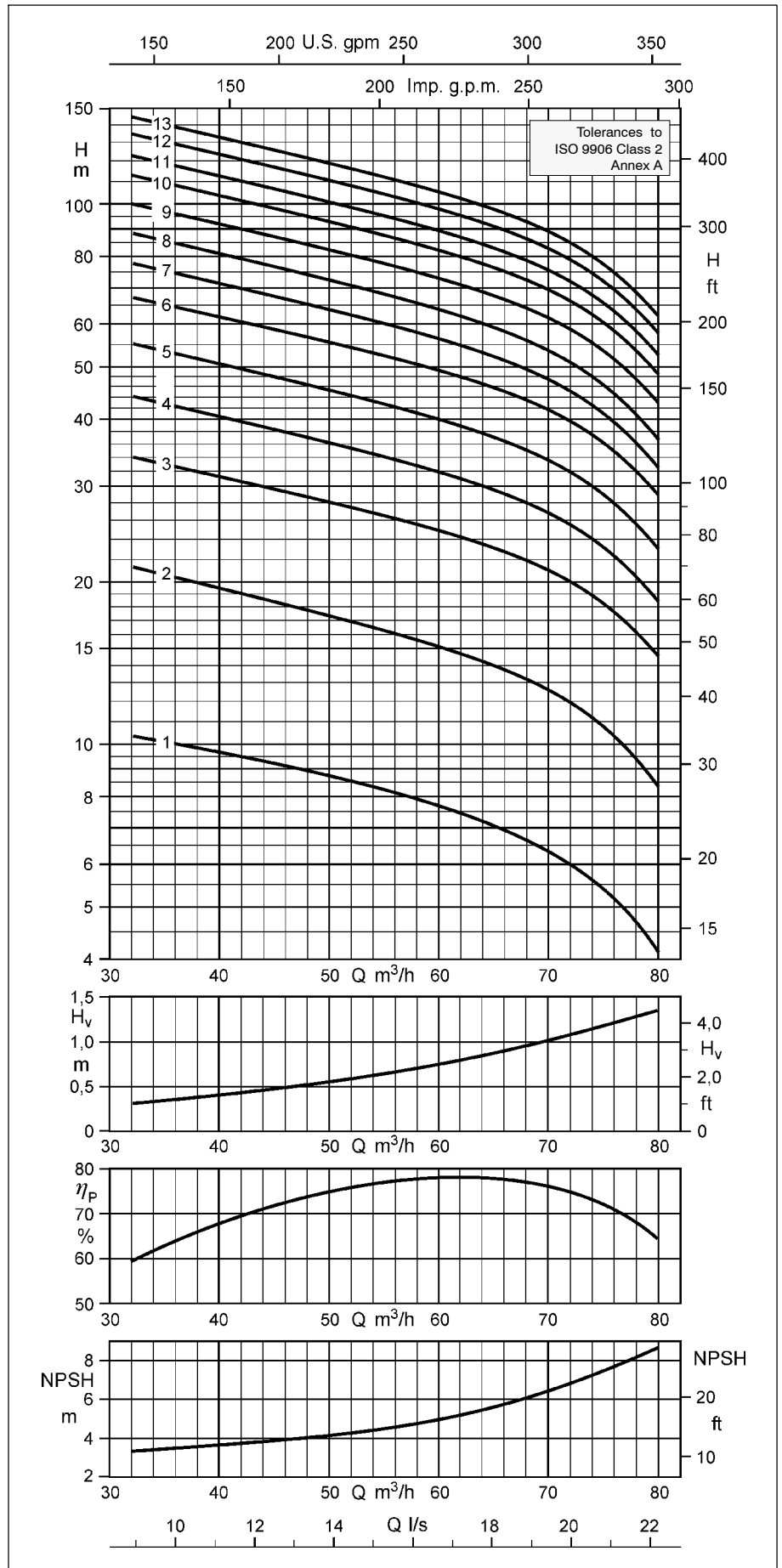
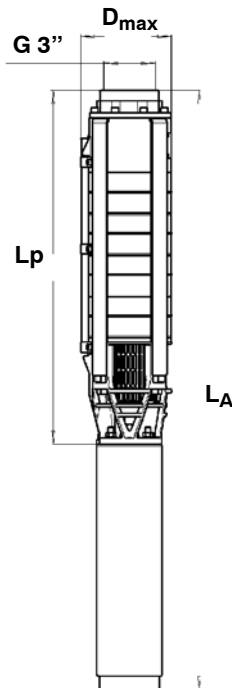

UPA 150C - 60 for Well Diameters of 150 mm (6 inches) and above

 Pumps with submersible motors for ... - Type of current / voltage **three-phase (3 ~) / 400 V**
 - Starting **d.o.l. (D) or star-delta (Y-Δ)**

UPA 150C - 60 / ...	Pump	Motor					Motor lead ²⁾ , flat	
	Discharge head Q = 0 m ³ /h	Rated power	Max. temperature of the fluid pumped v ≥ 0.2 m/s (0.0 m/s)	Rated current	Efficiency	Power factor	Number x cross-section of conductors (use under water, 400 V and ≤ +30 °C)	
	H ₀ m	P _N kW	t _{max} ¹⁾ °C	I _N A	η _M %	cos φ ---	d.o.l. mm ²	Y-Δ mm ²
14 + UMA 150D 26/21	194.0	26.0	31 (25)	55.0	84.5	0.82	4 x 6.0	3/4 x 4.0
15 + UMA 150D 30/21	210.0	29.0	32 (27)	63.0	84.5	0.80	4 x 6.0	3/4 x 4.0
16 + UMA 150D 30/21	223.0	30.0	30 (24)	65.0	84.5	0.80	4 x 6.0	3/4 x 4.0
17 + UMA 150D 37/22	237.0	33.0	44 (39)	72.0	84.0	0.79	3/4 x 4.0 ³⁾	3/4 x 4.0
18 + UMA 150D 37/22	251.0	35.0	43 (37)	76.0	84.0	0.80	3/4 x 4.0 ³⁾	3/4 x 4.0
19 + UMA 150D 37/22	264.0	36.0	41 (35)	77.0	83.5	0.81	3/4 x 4.0 ³⁾	3/4 x 4.0
20 + UMA 150D 37/22	277.0	37.0	39 (32)	79.0	83.5	0.82	3/4 x 4.0 ³⁾	3/4 x 4.0

¹⁾ also see page 36

²⁾ 3/4 = 1 x 3-core + 1 x 4-core, 90° spacing.

³⁾ Parallel cable

Dimensions / Weights / Horizontal Installation ¹⁾

UPA 150C - 60 / ...	L _p ≈ mm	L _A ≈ mm	m _A ≈ kg	D _{max} ≈ mm		Installation ²⁾
	for motor	incl. motor	incl. motor	d.o.l.	Y-Δ	
	UMA	UMA	UMA	UMA	UMA	
14	1907	3020	125.0	146	147	v ³⁾
15	2020	3235	136.0	146	147	v ³⁾
16	2133	3345	139.0	146	147	v ³⁾
17	2246	3540	148.0	145	147	v ³⁾
18	2359	3655	150.0	145	147	v ³⁾
19	2472	3765	153.0	145	147	v ³⁾
20	2585	3880	155.0	145	147	v ³⁾

¹⁾ Including check valve with threaded end and standard motor leads.

²⁾ v = vertical / h = horizontal.

³⁾ Horizontal installation on request

UPA 150C - 60 / ..., number of stages 14 - 20

The characteristic curves shown are for preliminary selection only. Exact selection data will be provided in our quotation.

Selection

The pressure losses H_v in the check valve are not considered in the pump characteristic curves.

Legend ...

H_v : Head losses in the check valve

η_p : Pump efficiency (not considering check valve)

NPSH: Net positive suction head required by the pump

Pump End G 3"

The information given below is based on the model with check valve and threaded end.

The changes in the main dimensions resulting from different threaded or flanged ends are specified in the table below.

	Overall length (mm)	D_{max} (mm)
G 3"	48	see page 54
G 4"	93	

Threaded end to DIN ISO 228, Part 1.
Flanged end to DIN 2501, Part 1

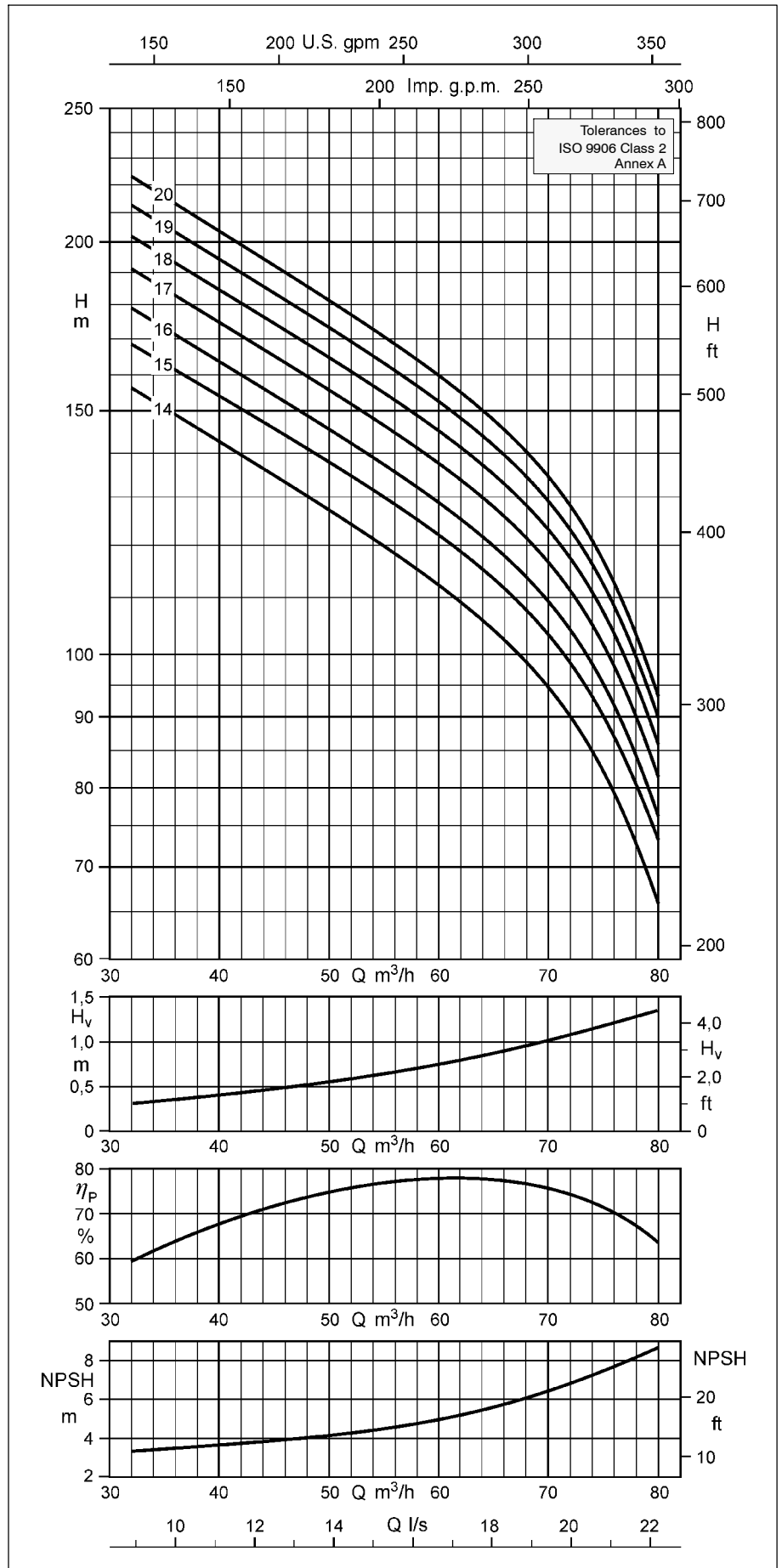
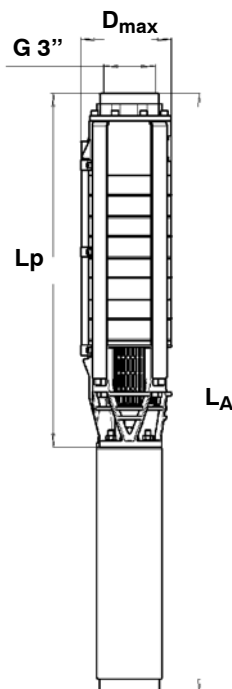

Applications

Handling clean or slightly contaminated water ...

- in general water supply systems,
- in irrigation and spray irrigation systems,
- in pressure boosting systems,
- in emergency water supply systems,
- in installations for lowering and maintaining ground water levels.

Also used in ...

- mining,
- sprinkler installations,
- fountains, etc.

Permissible sand content in the fluid handled: 50 g/m³.

Also suitable for aggressive seawater if supplied in material variant C3 (duplex).

Operating Data

Capacity	Q up to 330 m ³ /h (92 l/s)
Head	H up to 460 m
Temperature of fluid handled	t up to +50 °C
Speed	n ≈ 2900 rpm

Design

Single or multistage, single-entry centrifugal pumps in ring-section design. Mixed flow hydraulic systems with impellers that can be turned down. Stage casings connected by means of studs. Suction casing fitted between pump and motor. Suction casing equipped with strainer to protect the pump from coarse particles in the fluid.

Pumps with non-return valve or connection branch on option. Both models available with either threaded or flanged end. Particularly suitable for vertical installation in narrow deep wells.

Designation (Example)

UPA 200 B - 80 B / 5 d

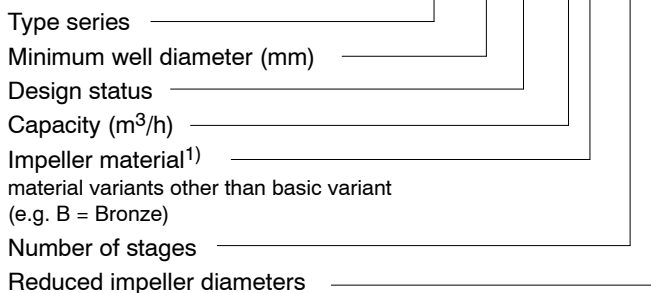

¹⁾ Applies to UPA 200B only.

Certification

Quality management certified to ISO 9001

Submersible Borehole Pumps for Well Diameters of 200 mm (8 inches) and of 250 mm (10 inches)



Product Features

- Very sturdy design
- Suitable for installation in narrow deep wells
- High efficiency
- Motor designed for maximum pump output
- Low noise level
- For vertical or horizontal installation
- Check valve protected against blocking
- Pre-filled motor; no risk of contamination of the pumped water

Selection Chart (Ranges on Offer)

n ≈ 2900 rpm

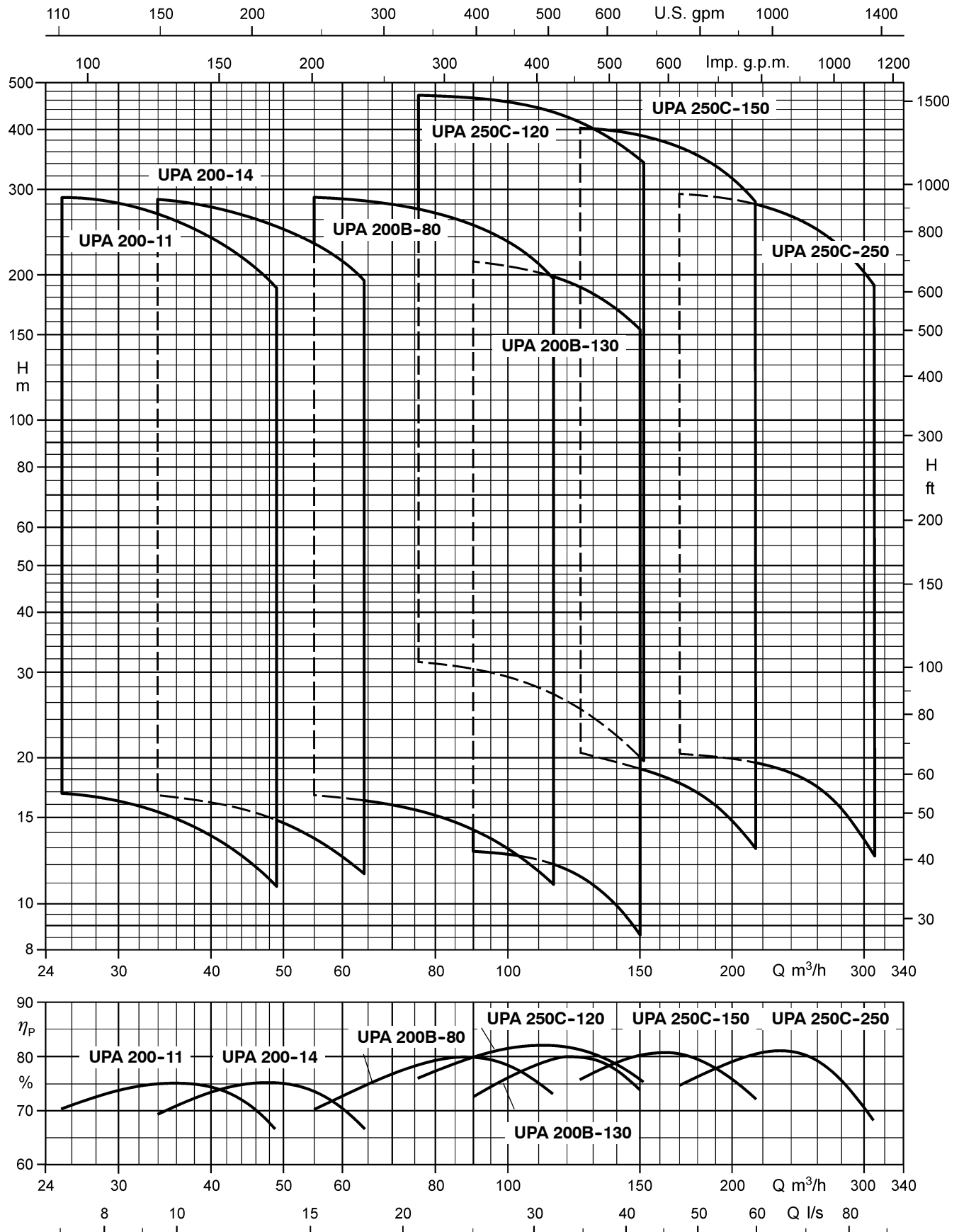

Note:
 The diagram shows the ΔQ_A range on offer. The pumps can be offered for any duty point within this range. The ΔQ_B operating ranges of the individual pump sizes are given in the characteristic curves for different stage numbers on the following pages.
Selection charts or performance curves for UPA in material variant C3 (duplex) on request only.

Material Variants - UPA 200

Component	G	B
Casing	Cast iron (JL1030) ¹⁾	Bronze (CC480K-GS) ²⁾
Impeller	Glass fibre reinforced NORYL (PPO)	
Diffuser	Glass fibre reinforced NORYL (PPO)	
Shaft	Cr steel (1.4021)	CrNiMo steel (1.4462)
Wear ring	CrNiMo steel (1.4401)	
Screws, bolts and nuts	CrNiMo steel (A4-70)	

¹⁾ DIN mat. code: GG-20

²⁾ DIN mat. code: CuSn10

Bearings / Lubrication

Plain bearing in the end stage, lubricated by the fluid handled. Axial thrust is balanced by a thrust bearing in the motor.

Direction of Rotation of the Pump

Clockwise rotation (when looking at the drive shaft end).

Pump End (Discharge Nozzle)

UPA 200 - 11 + 14: internal thread G 3" (DN 80).

Flanged end with adapter also available (see "Accessories").

Variants Available on Request

- Pumps with flanged end
- Pumps with connection branch with either threaded or flanged end

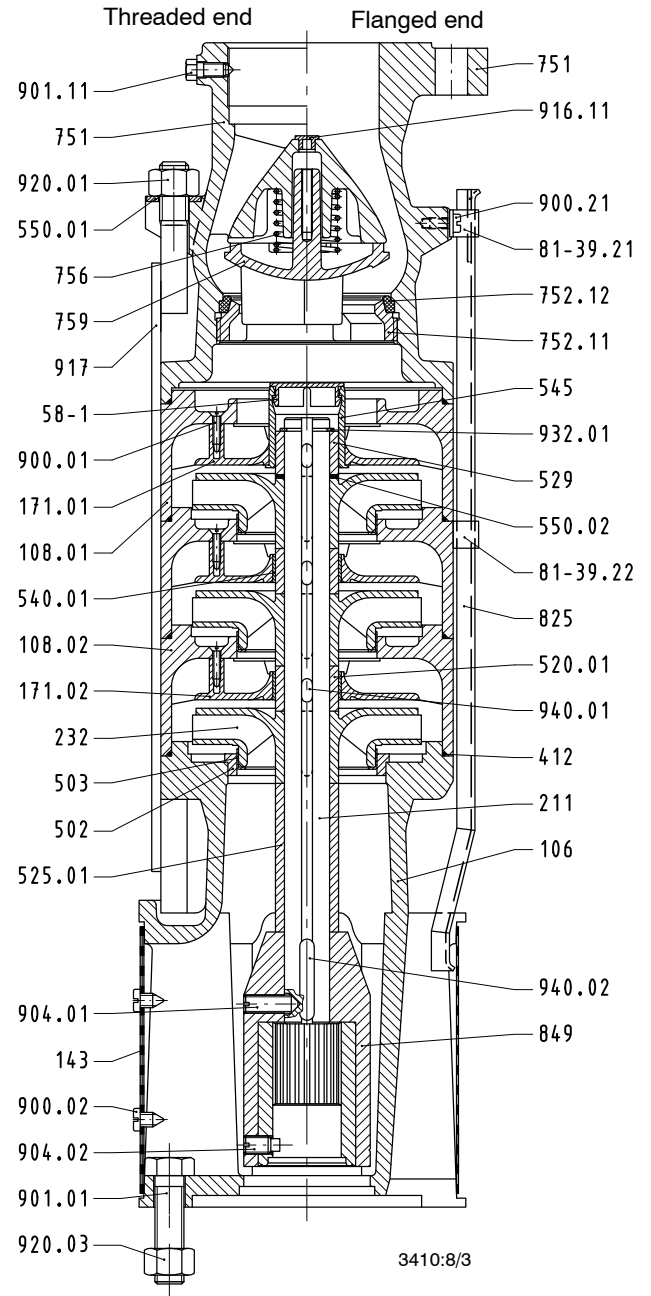

Example: UPA 200 - 14/3 with UMA 150D .. / 2.

Part No	Description
106/108	Suction casing / Stage casing
143	Suction strainer
171	Diffuser
211	Pump shaft
232	Clockwise impeller
503	Impeller wear ring
529/545	Bearing sleeve / Bearing bush
751	Valve body
849	Sleeve coupling
917	Tie bolt

Material Variants - UPA 200B, 250C

UPA pump		G	B	C3
Casing		Cast iron (JL1040) ¹⁾	Bronze (CC480K-GS) ²⁾	CrNiMo steel (1.4517)
Im-peller	200B	Glass fibre reinforced NORYL (PPO)	Bronze (CC480K-GS) ⁵⁾	CrNiMo steel (1.4517)
	250C	Bronze (CC480K-GS) ²⁾		
Shaft		Cr steel (1.4021)	CrNiMo steel (1.4462)	
Wear ring		high-performance plastics		CrNiMo steel (1.4538)
Screws, bolts and nuts ⁴⁾		CrNiMo steel (A4-70)		CrNiMo steel (1.4462)

UMA motor		G	C2	C3
Shaft	150D	CrNi steel (1.4305 ⁶⁾ / 1.4021 ⁷⁾	CrNiMo steel (1.4462)	CrNiMo steel (1.4462)
	200D	CrNiMo steel (1.4462)	CrNiMo steel (1.4462)	CrNiMo steel (1.4462)
	250D		--	CrNiMo steel (1.4462)
	300D			CrNiMo steel (1.4462)
Housing	150D	Cast iron (JL1030) ³⁾	CrNiMo steel (1.4409)	CrNiMo steel (1.4539)
	200D		CrNiMo steel (1.4408)	
	250D		--	CrNiMo steel (1.4517)
	300D	Cast iron (JL1040) ¹⁾		
Stator case	150D	CrNi steel (1.4301)	CrNiMo steel (1.4571)	CrNiMo steel (1.4539)
	200D		--	
	250D			
	300D	CrNi steel (1.4301)	CrNiMo steel (1.4462)	
Screws bolts and nuts ⁴⁾	150D	CrNi steel (1.4301)	CrNiMo steel (A4-70)	CrNiMo steel (1.4539)
	200D	CrNiMo steel (A4-70)	CrNiMo steel (A4-70)	
	250D	CrNiMo steel (1.4571)	--	CrNiMo steel (1.4462)
	300D			

1) DIN mat. code: GG-25
 2) DIN mat. code: CuSn10
 3) DIN mat. code: GG-20
 4) Wetted by fluid handled
 5) for size 80B and 130B
 6) only for size UMA 150D ≤ 22/21
 7) only for size UMA 150D > 22/21

Bearings / Lubrication

Radial plain bearings; pump bearings lubricated by the fluid handled, motor bearings by the motor's water fill. Depending on the number of stages, 1 intermediate bearing is fitted on the pump unit.

Axial thrust is balanced by a tilting-pad thrust bearing in the motor (lower end).

Direction of Rotation of the Pump

Clockwise rotation (when looking at the drive shaft end).

Pump End (Discharge Nozzle)

G 5" and G 6" threaded ends depending on the size. DN 125 and DN 150 flanges available on option.

Coating (Standard)

Quality 2-component high-build coating (epoxy resin base), approved for drinking water contact
 Coating structure .. Primer and top coat
 Film thickness 100 to 150 µm
 Colour ultramarine blue (RAL 5002)

Type of Installation

In general, the pumps are installed vertically. Some models may also be installed horizontally depending on the number of stages and motor size.

Drive

Motor type water-filled submersible squirrel-cage motor, 2 poles
 Enclosure IP 68
 Frequency 50 Hz
 Type of current three-phase (3~)
 Rated voltage U up to 500 V
 Rated power P_N up to 250 kW
 Frequency of starts 15/h ¹⁾, 10/h ²⁾ and 5/h ³⁾
 Minimum delay before restarting 1 min ¹⁾ and 3 min ²⁾ ³⁾
 Motor design is in compliance with VDE regulations.

¹⁾ Motor UMA 150D
²⁾ Motors UMA 200D and 250D
³⁾ Motor UMA 300D

Connection to Power Supply

The submersible motors are supplied ex factory with 1 or 2 motor leads, each equipped with an earth conductor. All motors are provided with internal earthing. Any extension cables required are connected using water-tight cable connectors. Motor leads and extension cables are suitable for drinking water applications.

Starting

D.o.l. (autotransformer or soft starter) or star-delta.

Variable Speed

The submersible borehole pumps can also be equipped with a speed control system to accommodate different operating points.

Application Temperatures

The submersible borehole pumps are, as a standard, suitable for use in water with temperatures of up to t = +30 °C. An indispensable requirement for this is a flow velocity of v = 0.2 m/s past the motor. This requirement is met, for example, when the pump is installed in a deep well above the well screen / filter, etc.

With certain restrictions, some motor sizes may also be used in water with temperatures of up to t = +50 °C or for operation without an adequate cooling flow of water past the motor, i.e. v = 0 m/s (for example, when the unit is installed in a deep well below the screen / filter area or in a pump sump, etc.).

Variants Available on Request

- Other materials
- More wear-resistant designs
- Other supply voltages up to 1000 V
- 60 Hz motors
- Models with cooling, suction or pressure shroud

Design Features

Check valve with anti-blockage valve disc

- No jamming or tilting.
- Spring-loaded design makes for minimum valve closing times and prevents waterhammer.
- High operating reliability.

Robust wear rings

- Replaceable wear rings made of corrosion- and wear-resistant metal.
- Protection against wear in the clearance; easy servicing.

Integrated sand separator

- Tried and tested KSB patent [®].
- Added protection from abrasive wear for shafts and bearing areas.
- Long service life and high operating reliability.

Wear-resistant mechanical seal

- Long service life and high operating reliability.

Counter thrust bearing

- Reliable balancing of negative axial thrust.
- Impellers do not rub on the stage casings.

Tried and tested thrust bearing

- Water-lubricated self-aligning tilting-pad journal bearing.
- No-maintenance design suitable for maximum load-carrying capacity under continuous operation conditions.
- New materials combination (stainless steel / carbon) for high safety factor.

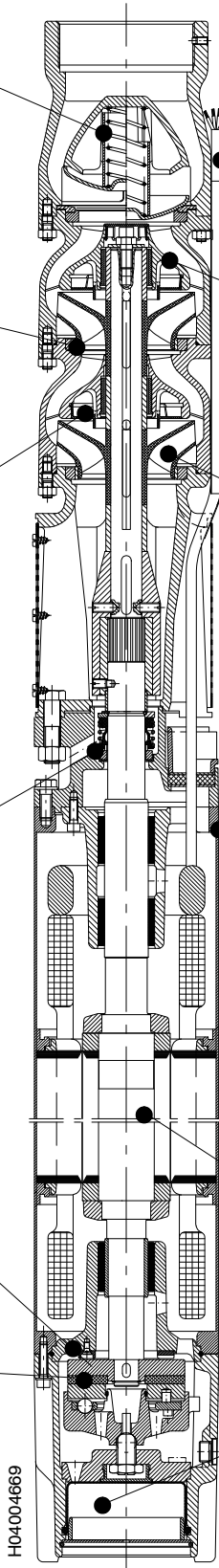

All wetted plastic components are approved for contact drinking water (BAM ¹⁾)

- Coating, electric cables, seal elements, gaskets, etc. are absolutely fit for use in drinking water applications.

1) German Federal Institute for Materials Research

Enclosed pump bearing

- No-maintenance design, high wear resistance.
- For trouble-free long-term operation.

New: Energy-efficient hydraulic systems

- High efficiency and low energy costs.

The KSB motor

- VDE-compliant, i.e., high level of electrical safety.
- Designed for max. pump power to protect unit from overloads.

Dynamically balanced rotor

- Ensures smooth running.

Reliable pressure balancing system

- Optimum rubber expansion diaphragm design.
- Enables installation at very low depths.

UPA 200 – 11 for Well Diameters of 200 mm (8 inches) and above

 Pumps with submersible motors for **three-phase current (3~) / 400 V / d.o.l. (D) or star-delta (Y-Δ) starting**

Pump + motor	Pump	Motor					Motor lead ²⁾ , flat	
	Discharge head Q = 0 m ³ /h H ₀ m	Rated power P _N kW	Max. temperature of the fluid pumped v ≥ 0.2 m/s (= 0 m/s) t _{max} ¹⁾ °C	Rated current I _N A	Efficiency η _M %	Power factor cos φ --	Number x cross-section of conductors (use under water, 400 V and ≤+30 °C) D.o.l. mm ² Y-Δ mm ²	
UPA 200 - 11/ ... + ..								
1e + UMA 150D 5/21	19	2.5	45 (42)	9.5	70.2	0.57	4 x 2.5	3/4 x 2.5
1d + UMA 150D 5/21	20	2.5	45 (42)	9.5	70.2	0.57	4 x 2.5	3/4 x 2.5
1 + UMA 150D 5/21	23	3.5	45 (42)	10.6	75.2	0.67	4 x 2.5	3/4 x 2.5
2e + UMA 150D 5/21	36	4.5	42 (39)	12.0	76.4	0.74	4 x 2.5	3/4 x 2.5
2c + UMA 150D 5/21	41	5.5	39 (35)	13.6	75.7	0.80	4 x 2.5	3/4 x 2.5
2 + UMA 150D 7/21	45	6.0	38 (34)	15.1	77.6	0.77	4 x 2.5	3/4 x 2.5
3d + UMA 150D 7/21	59	7.0	35 (30)	16.8	76.9	0.81	4 x 2.5	3/4 x 2.5
3 + UMA 150D 9/21	66	9.0	32 (27)	20.5	77.9	0.82	4 x 2.5	3/4 x 2.5
4c + UMA 150D 13/21	83	10.0	37 (33)	24.0	80.8	0.75	4 x 2.5	3/4 x 2.5
4 + UMA 150D 13/21	89	12.0	33 (28)	27.0	80.5	0.80	4 x 2.5	3/4 x 2.5
5b + UMA 150D 13/21	103	12.5	31 (35)	28.0	80.4	0.80	4 x 2.5	3/4 x 2.5
5 + UMA 150D 15/21	110	14.5	32 (37)	31.5	81.9	0.82	4 x 4.0	3/4 x 2.5
6b + UMA 150D 15/21	123	15.0	31 (35)	32.5	81.7	0.83	4 x 4.0	3/4 x 2.5
6 + UMA 150D 18/21	133	17.5	29 (23)	39.0	82.0	0.80	4 x 4.0	3/4 x 2.5
7 + UMA 150D 22/21	155	21.0	32 (27)	46.0	83.5	0.80	4 x 4.0	3/4 x 2.5
8 + UMA 150D 26/21	178	24.0	35 (31)	52.0	84.9	0.80	4 x 6.0	3/4 x 4.0
9 + UMA 150D 26/21	199	26.0	32 (26)	55.0	84.6	0.82	4 x 6.0	3/4 x 4.0
10 + UMA 150D 30/21	222	29.0	32 (26)	63.0	84.6	0.80	4 x 6.0	3/4 x 4.0
11 + UMA 150D 37/22	245	32.0	45 (40)	71.0	84.2	0.78	3/4 x 4.0 ⁴⁾	3/4 x 4.0
12 + UMA 150D 37/22	266	35.0	42 (36)	76.0	83.9	0.80	3/4 x 4.0 ⁴⁾	3/4 x 4.0
13 + UMA 150D 37/22	286	37.0	39 (33)	79.0	83.6	0.82	3/4 x 4.0 ⁴⁾	3/4 x 4.0
14 + UMA 200D 45/21	315	42.0	30 (25)	85.0	86.1	0.83	3/4 x 6.0 ³⁾	3/4 x 6.0

1) Also see pages 3 and 60.

2) 3/4 = 1 x 3-core + 1 x 4-core, 90° spacing.

3) Delta wiring in the cable connector or control cabinet.

4) cable parallel

Dimensions / Weights / Horizontal Installation ¹⁾

Pump unit	L _p mm	L _A ≈ mm		m _A ≈ kg		D _{max} ≈ mm		Installation ²⁾	A ≈ mm
		G (Standard)	B (Special)	G (Standard)	B (Special)	D.o.l.	Y-Δ		
UPA 200 - 11/ ..									
1e	515	1215	1225	66	69	192	195	v + h	645
1d	515	1215	1225	66	69	192	195	v + h	645
1	515	1215	1225	66	69	192	195	v + h	645
2e	580	1280	1290	70	74	192	195	v + h	710
2c	580	1280	1290	70	74	192	195	v + h	710
2	580	1300	1310	72	76	192	195	v + h	720
3d	645	1365	1375	75	79	192	195	v + h	785
3	645	1395	1405	78	82	192	195	v + h	800
4c	710	1540	1550	88	93	192	195	v + h	905
4	710	1540	1550	88	93	192	195	v + h	905
5b	775	1605	1615	92	97	192	195	v + h	970
5	775	1650	1660	96	101	193	195	v + h	990
6b	840	1715	1725	99	105	193	195	v + h	1055
6	840	1760	1770	103	109	193	195	v + h	1080
7	905	1915	1925	114	120	193	195	v + h	1190
8	970	2085	2095	127	134	194	196	v + h	1305
9	1035	2150	2160	130	137	194	196	v + h	1370
10	1100	2315	2325	142	150	194	196	v + h	1485
11	1165	2460	2470	152	160	196	196	v ³⁾	-
12	1230	2525	2535	156	165	196	196	v ³⁾	-
13	1295	2590	2600	159	168	196	196	v ³⁾	-
14	1360	2590	2590	220	230	199	199	v + h	1755

1) Including check valve with threaded end and standard motor leads.

2) v = vertical and h = horizontal.

3) Horizontal installation on request.

UPA 200 - 11 / ..

The characteristic curves shown are for preliminary selection only. Exact selection data will be provided in our quotation.

Selection

The pressure losses H_v in the check valve are not considered in the pump characteristic curves. For more details and a selection example refer to page 8.

Legend ...

- H_v : Head losses in the check valve
- η_p : Pump efficiency (not considering check valve)
- NPSH: Net positive suction head required by the pump

Pump End G 3" / DN 80

The information is based on the model "with check valve / connection branch and threaded end".

The changes in the main dimensions of the "flanged end" model are specified in the table below.

Check valve / connection branch with:

Threaded end G 3"	Flanged end DN 80	
Length mm	Length mm	Outside diameter mm
200	200 (PN 10/16)	200
	200 (PN 25/40)	200

Threaded end to DIN ISO 228, Part 1

Flange mating dimensions to DIN 2501, Part 1

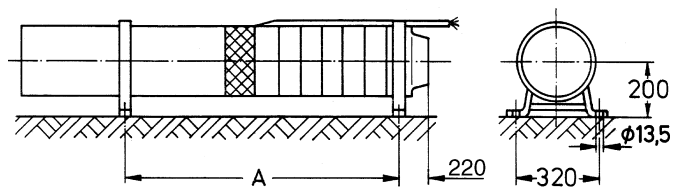
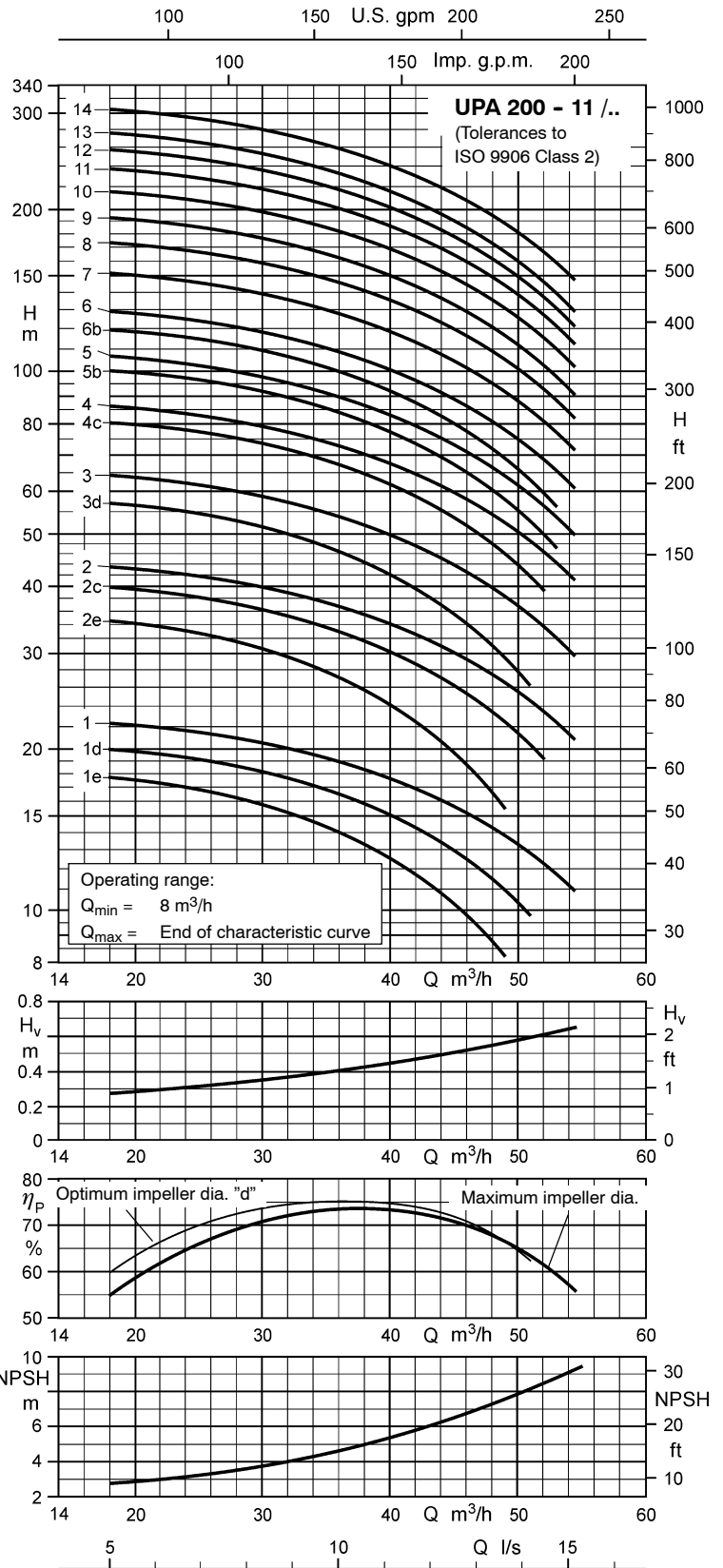
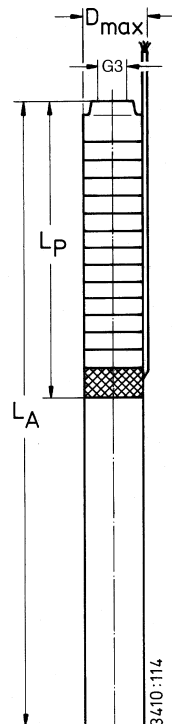

UPA 200 -14 for Well Diameters of 200 mm (8 inches) and above

Pumps with submersible motors for **three-phase current (3~) / 400 V / d.o.l. (D) or star-delta (Y-Δ) starting**

Pump + motor	Pump	Motor					Motor lead ²⁾ , flat	
	Discharge head Q = 0 m ³ /h H ₀ m	Rated power P _N kW	Max. temperature of the fluid pumped v ≥ 0.2 m/s (= 0 m/s) t _{max} ¹⁾ °C	Rated current I _N A	Efficiency η _M %	Power factor cos φ --	Number x cross-section of conductors (use under water, 400 V and ≤ +30 °C) D.o.l. mm ² Y-Δ mm ²	
UPA 200 - 14/ ... + ...								
1e + UMA 150D 5/21	18	3.0	45 (42)	10.0	73.4	0.62	4 x 2.5	3/4 x 2.5
1d + UMA 150D 5/21	21	3.5	44 (41)	10.6	75.2	0.67	4 x 2.5	3/4 x 2.5
1 + UMA 150D 5/21	25	4.5	42 (39)	12.0	76.4	0.74	4 x 2.5	3/4 x 2.5
2e + UMA 150D 7/21	35	6.0	39 (35)	15.1	77.6	0.77	4 x 2.5	3/4 x 2.5
2d + UMA 150D 7/11	42	7.0	35 (31)	16.8	76.9	0.81	4 x 2.5	3/4 x 2.5
2 + UMA 150D 9/21	50	8.5	34 (29)	20.0	78.3	0.81	4 x 2.5	3/4 x 2.5
3d + UMA 150D 13/21	65	10.5	36 (32)	25.0	80.8	0.76	4 x 2.5	3/4 x 2.5
3 + UMA 150D 13/21	75	12.5	31 (25)	28.0	80.4	0.80	4 x 2.5	3/4 x 2.5
4c + UMA 150D 15/21	90	14.5	32 (27)	31.5	81.9	0.82	4 x 4.0	3/4 x 2.5
4 + UMA 150D 18/21	101	17.0	31 (25)	38.0	82.1	0.79	4 x 4.0	3/4 x 2.5
5c + UMA 150D 18/21	113	18.0	28 (21)	39.5	81.8	0.81	4 x 4.0	3/4 x 2.5
5 + UMA 150D 22/21	126	21.0	31 (26)	46.0	83.5	0.80	4 x 4.0	3/4 x 2.5
6c + UMA 150D 22/21	136	22.0	30 (24)	47.5	83.3	0.81	4 x 4.0	3/4 x 2.5
6 + UMA 150D 26/21	151	25.0	33 (28)	53.0	84.8	0.81	4 x 6.0	3/4 x 4.0
7c + UMA 150D 26/21	159	26.0	33 (28)	55.0	84.6	0.82	4 x 6.0	3/4 x 4.0
7 + UMA 150D 30/21	177	30.0	32 (26)	65.0	84.5	0.80	4 x 6.0	3/4 x 4.0
8 + UMA 150D 37/22	202	34.0	43 (38)	74.0	84.0	0.80	3/4 x 4.0 ⁴⁾	3/4 x 4.0
9 + UMA 150D 37/22	225	37.0	39 (33)	79.0	83.6	0.82	3/4 x 4.0 ⁴⁾	3/4 x 4.0
10 + UMA 200D 45/21	255	44.0	30 (24)	89.0	86.0	0.84	3/4 x 6.0 ³⁾	3/4 x 6.0
11 + UMA 200D 55/21	283	48.0	33 (27)	98.0	87.2	0.82	3/4 x 6.0 ³⁾	3/4 x 6.0
12 + UMA 200D 55/21	307	52.0	30 (24)	104.0	87.1	0.83	3/4 x 6.0 ³⁾	3/4 x 6.0
13 + UMA 200D 55/21	331	55.0	27 (21)	109.0	86.9	0.84	3/4 x 6.0 ³⁾	3/4 x 6.0

¹⁾ Also see pages 3 and 60.

²⁾ 3/4 = 1 x 3-core + 1 x 4-core, 90° spacing.

³⁾ Delta wiring in the cable connector or control cabinet.

⁴⁾ cable parallel

Dimensions / Weights / Horizontal Installation ¹⁾

Pump unit	L _p mm	L _A ≈ mm		m _A ≈ kg		D _{max} ≈ mm		Installation ²⁾	A ≈ mm
		G (Standard)	B (Special)	G (Standard)	B (Special)	D.o.l.	Y-Δ		
UPA 200 - 14/ ..									
1e	530	1230	1240	67	70	192	195	v + h	660
1d	530	1230	1240	67	70	192	195	v + h	660
1	530	1230	1240	67	70	192	195	v + h	660
2e	610	1330	1340	73	77	192	195	v + h	750
2d	610	1330	1340	73	77	192	195	v + h	750
2	610	1360	1370	76	80	192	195	v + h	765
3d	690	1520	1530	87	91	192	195	v + h	885
3	690	1520	1530	87	91	192	195	v + h	885
4c	770	1645	1655	95	100	193	195	v + h	985
4	770	1690	1700	99	104	193	195	v + h	1010
5c	850	1770	1780	106	111	193	195	v + h	1090
5	850	1860	1870	114	119	193	195	v + h	1135
6c	930	1940	1950	117	123	193	195	v + h	1215
6	930	2045	2055	126	132	194	196	v + h	1265
7c	1010	2125	2135	130	136	194	196	v + h	1345
7	1010	2225	2235	139	145	194	196	v + h	1395
8	1090	2385	2395	150	157	196	196	v ³⁾	-
9	1170	2465	2475	151	158	196	196	v ³⁾	-
10	1250	2480	2480	213	221	199	199	v + h	1645
11	1330	2670	2670	237	245	199	199	v + h	1780
12	1410	2750	2750	241	250	199	199	v + h	1860
13	1490	2830	2830	245	254	199	199	v + h	1940

¹⁾ Including check valve with threaded end and standard motor leads.

²⁾ v = vertical and h = horizontal.

³⁾ Horizontal installation on request.

UPA 200 - 14 / ..

The characteristic curves shown are for preliminary selection only. Exact selection data will be provided in our quotation.

Selection

The pressure losses H_v in the check valve are not considered in the pump characteristic curves. For more details and a selection example refer to page 8.

Legend ...

- H_v : Head losses in the check valve.
- η_p : Pump efficiency (not considering check valve).
- NPSH: Net positive suction head required by the pump.

Pump End G 3" / DN 80

The information is based on the model "with check valve / connection branch and threaded end.

The changes in the main dimensions of the "flanged end" model are specified in the table below.

Check valve / connection branch with

Threaded end G 3"		Flanged end DN 80	
Length mm	Length mm	Outside diameter mm	
200	200 (PN 10/16) 200 (PN 25/40)	200	200

Threaded end to DIN ISO 228, Part 1

Flange mating dimensions to DIN 2501, Part 1

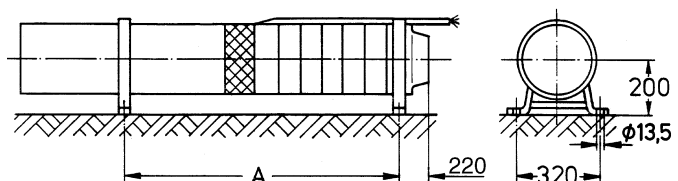
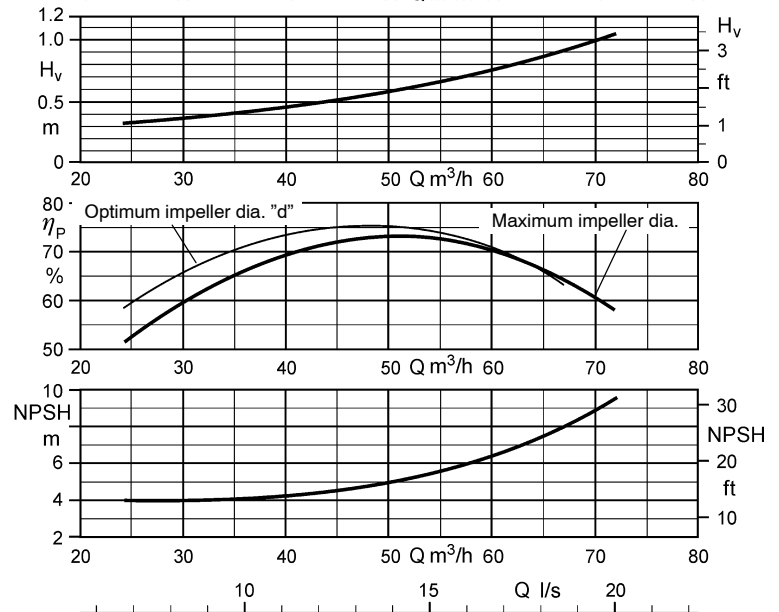
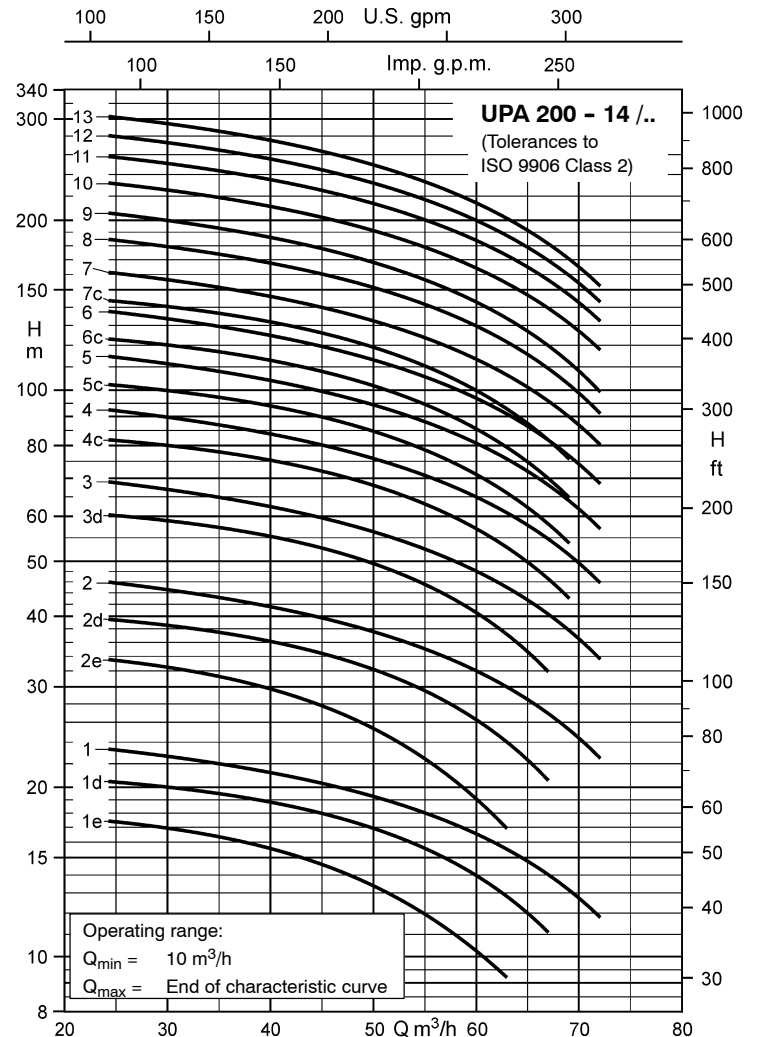
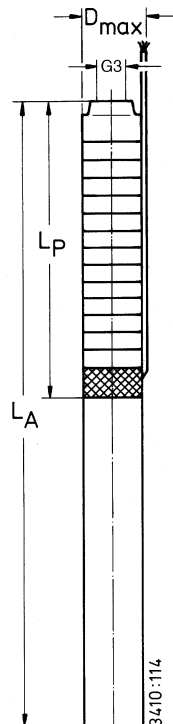

UPA 200B - 80 for Well Diameters of 200 mm (8 inches) and above

 Pumps with submersible motors for **three-phase current (3~) / 400 V / d.o.l. (D) or star-delta (Y-Δ) starting**

Pump + motor	Pump		Motor				Motor lead ²⁾ , flat	
	Discharge head Q = 0 m ³ /h	Rated power	Max. temperature of the fluid pumped v ≥ 0.2 m/s (= 0 m/s)	Rated current	Efficiency	Power factor	Number x cross-section of conductors (use under water, 400 V and ≤ +30 °C)	
UPA 200B - 80/.. + ...	H ₀ m	P _N kW	t _{max} ¹⁾ °C	I _N A	η _M %	cos φ --	D.o.l. mm ²	Y-Δ mm ²
1g + UMA 150D 5/21	20	5.5	37 (33)	13.6	75.7	0.80	4 x 2.5	3/4 x 2.5
1f + UMA 150D 7/21	24	6.0	38 (34)	15.1	77.6	0.77	4 x 2.5	3/4 x 2.5
1d + UMA 150D 7/21	25	7.5	33 (28)	17.8	76.4	0.82	4 x 2.5	3/4 x 2.5
1 + UMA 150D 9/21	27	8.0	34 (30)	19.0	78.6	0.80	4 x 2.5	3/4 x 2.5
2g + UMA 150D 13/21	39	10.5	37 (33)	25.0	80.8	0.76	4 x 2.5	3/4 x 2.5
2f + UMA 150D 13/21	44	12.0	33 (27)	27.0	80.5	0.80	4 x 2.5	3/4 x 2.5
2d + UMA 150D 15/21	48	14.5	33 (28)	31.5	81.9	0.82	4 x 4.0	3/4 x 2.5
2 + UMA 150D 18/21	53	16.0	32 (26)	36.5	82.3	0.78	4 x 4.0	3/4 x 2.5
3f + UMA 150D 18/21	67	16.0	32 (26)	36.5	82.3	0.78	4 x 4.0	3/4 x 2.5
3e + UMA 150D 18/21	70	18.0	28 (22)	39.5	81.8	0.81	4 x 4.0	3/4 x 2.5
3d + UMA 150D 22/21	73	20.0	33 (28)	44.0	83.6	0.79	4 x 4.0	3/4 x 2.5
3 + UMA 150D 22/21	78	22.0	29 (22)	47.5	83.3	0.81	4 x 4.0	3/4 x 2.5
4e + UMA 150D 26/21	94	24.0	35 (30)	52.0	84.9	0.80	4 x 6.0	3/4 x 4.0
4c + UMA 150D 30/21	99	28.0	33 (28)	61.0	84.7	0.79	4 x 6.0	3/4 x 4.0
4 + UMA 150D 30/21	104	30.0	31 (25)	65.0	84.5	0.80	4 x 6.0	3/4 x 4.0
5d + UMA 150D 37/22	122	33.0	44 (39)	72.0	84.1	0.79	3/4 x 4.0 ⁴⁾	3/4 x 4.0
5 + UMA 150D 37/22	129	37.0	39 (33)	79.0	83.6	0.82	3/4 x 4.0 ⁴⁾	3/4 x 4.0
6c + UMA 200D 45/21	150	44.0	30 (24)	89.0	86.0	0.84	3/4 x 6.0 ³⁾	3/4 x 6.0
6 + UMA 200D 45/21	158	45.0	27 (20)	90.0	86.0	0.84	3/4 x 6.0 ³⁾	3/4 x 6.0
7c + UMA 200D 55/21	176	50.0	31 (25)	101.0	87.2	0.83	3/4 x 6.0 ³⁾	3/4 x 6.0
7 + UMA 200D 55/21	185	54.0	28 (22)	108.0	87.0	0.84	3/4 x 6.0 ³⁾	3/4 x 6.0
8c + UMA 200D 55/21	200	55.0	26 (20)	190.0	86.9	0.84	3/4 x 6.0 ³⁾	3/4 x 6.0
8 + UMA 200D 65/21	213	62.0	30 (23)	123.0	87.7	0.83	3/4 x 10 ³⁾	3/4 x 10
9 + UMA 200D 75/21	239	70.0	27 (20)	143.0	87.4	0.81	3/4 x 10 ³⁾	3/4 x 10
10 + UMA 200D 75/21	264	75.0	22 (15)	151.0	87.3	0.83	3/4 x 10 ³⁾	3/4 x 10
11 + UMA 200D 90/21	292	86.0	27 (20)	173.0	88.1	0.82	3/4 x 16 ³⁾	3/4 x 16
12 + UMA 200D 90/21	317	90.0	23 (16)	181.0	88.0	0.82	3/4 x 16 ³⁾	3/4 x 16

1) also see pages 3 and 60.

2) 3/4 = 1 x 3-core + 1 x 4-core, 90° spacing.

3) Delta wiring in the cable connector or control cabinet.

4) Parallel cable

Dimensions / Weights / Horizontal Installation ¹⁾

UPA 200B- 80/..	L _p mm	L _A ≈ mm		m _A ≈ kg		D _{max} ≈ mm		Installation ²⁾	A ≈ mm
		G (Standard)	B (Special)	G (Standard)	B (Special)	D.o.l.	Y-Δ		
1g	582	1280	1295	86	93	193	196	v + h	620
1f	582	1300	1315	88	95	193	196	v + h	630
1d	582	1300	1315	88	95	193	196	v + h	630
1	582	1330	1345	91	98	193	196	v + h	645
2g	714	1545	1555	108	118	193	196	v + h	820
2f	714	1545	1555	108	118	193	196	v + h	820
2d	714	1590	1600	112	122	194	196	v + h	840
2	714	1635	1645	116	126	194	196	v + h	865
3f	846	1765	1780	127	138	194	196	v + h	995
3e	846	1765	1780	127	138	194	196	v + h	995
3d	846	1855	1870	135	146	194	196	v + h	1040
3	846	1855	1870	135	146	194	196	v + h	1040
4e	978	2090	2105	154	168	195	198	v + h	1225
4c	978	2190	2205	163	176	195	198	v + h	1275
4	978	2190	2205	163	176	195	198	v + h	1275
5d	1110	2405	2415	181	195	198	198	v ³⁾	-
5	1110	2405	2415	181	195	198	198	v ³⁾	-
6c	1242	2475	2475	246	264	201	201	v + h	1550
6	1242	2475	2475	246	264	201	201	v + h	1550
7c	1374	2715	2715	277	296	201	201	v + h	1735
7	1374	2715	2715	277	296	201	201	v + h	1735
8c	1506	2845	2845	287	308	201	201	v + h	1865
8	1506	2975	2975	310	331	205	205	v + h	1930
9	1638	3200	3200	337	359	205	205	v ⁴⁾	-
10	1770	3330	3330	347	371	205	205	v ⁴⁾	-
11	1902	3645	3645	390	415	211	211	v ^{3) 4)}	-
12	2034	3775	3775	400	427	211	211	v ^{3) 4)}	-

1) Including check valve with threaded end and standard motor leads.

2) v = vertical and h = horizontal.

3) Horizontal installation on request.

4) Horizontal installation only with bearing pedestals of special design.

UPA 200B - 80 / ..

The characteristic curves shown are for preliminary selection only. Exact selection data will be provided in our quotation.

Selection

The characteristic curves shown apply to the standard impeller material, i.e. Noryl.

The performance data for the full impeller diameter and impeller diameter "b" for the given number of stages will only be achieved when the impellers are made of Noryl (PPO).

For the special impeller material (bronze), please select the next higher number of stages.

In this case, please refer to the characteristic curves individually prepared for the quotation.

The pressure losses H_v in the check valve are not considered in the pump characteristic curves.

For more details and a selection example refer to pages 8.

Legend ...

- H_v : Head losses in the check valve.
- η_p : Pump efficiency (not considering check valve).
- NPSH: Net positive suction head required by the pump.

Pump End G 5" / DN 125

The information is based on the model "with check valve / connection branch and threaded end".

The changes in the main dimensions of the "flanged end" model are specified in the table below.

Check valve / connection branch with

Threaded end G 5"	Flanged end DN 125	
	Length mm	Outside diameter mm
200	150 (PN 10/16)	250
	150 (PN 25/40)	270

Threaded end to DIN ISO 228, Part 1.
Flange mating dimensions to DIN 2501, Part 1

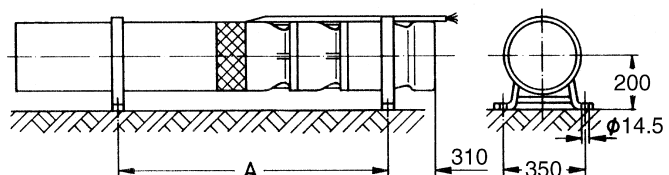
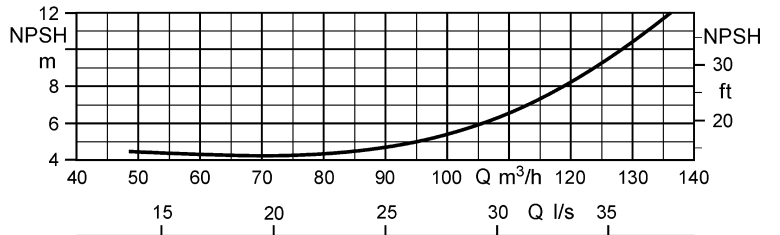
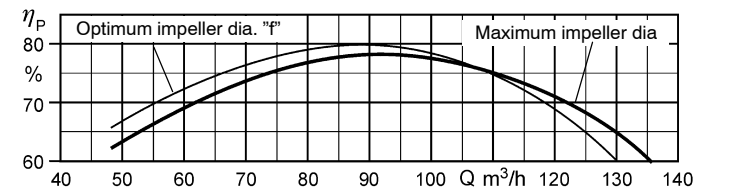
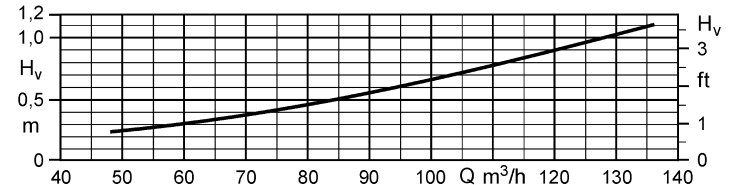
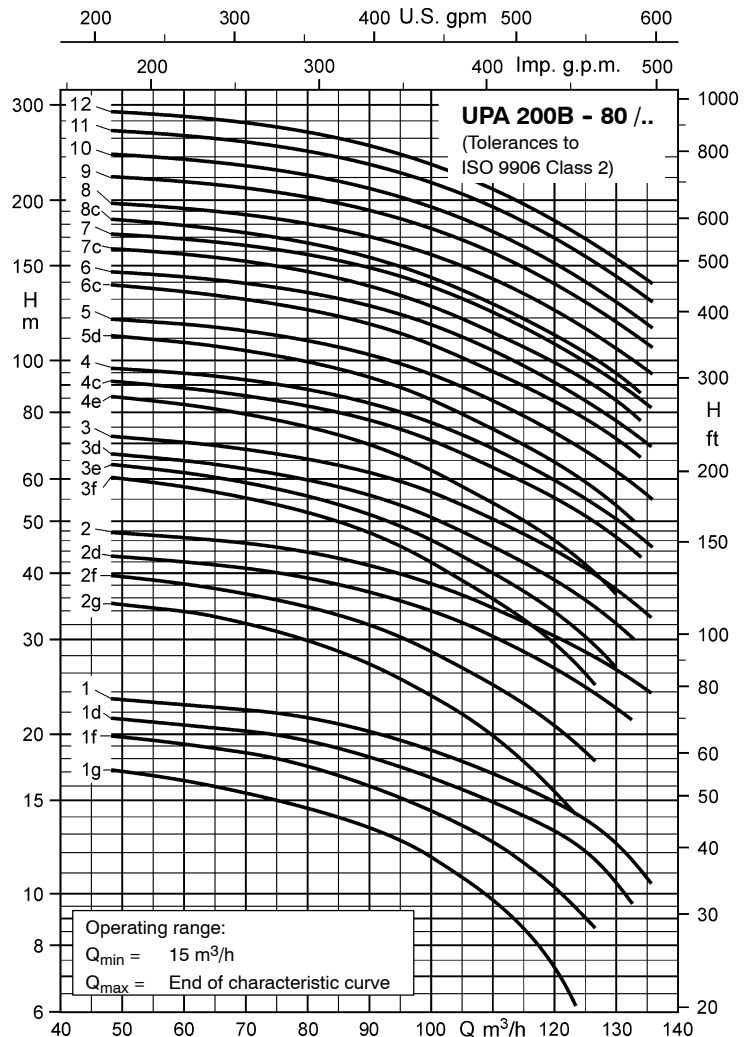
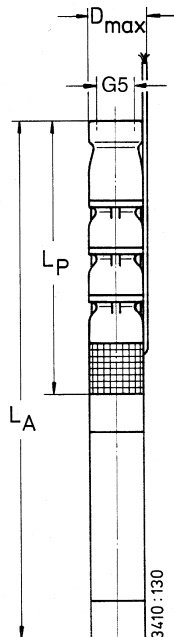

UPA 200B - 130 for Well Diameters of 200 mm (8 inches) and above

Pumps with submersible motors for **three-phase current (3~) / 400 V / d.o.l. (D) or star-delta (Y-Δ) starting**

Pump + motor	Pump		Motor				Motor lead ²⁾ , flat	
	Discharge head Q = 0 m ³ /h	Rated power	Max. temperature of the fluid pumped v ≥ 0.2 m/s (= 0 m/s)	Rated current	Efficiency	Power factor	Number x cross-section of conductors (use under water, 400 V and ≤ +30 °C)	
UPA 200B - 130/.. + ...	H ₀ m	P _N kW	t _{max} ¹⁾ °C	I _N A	η _M %	cos φ --	D.o.l. mm ²	Y-Δ mm ²
1g + UMA 150D 5/21	17	5.5	37 (33)	13.6	75.7	0.80	4 x 2.5	3/4 x 2.5
1e + UMA 150D 7/21	20	6.5	36 (32)	16.0	77.3	0.79	4 x 2.5	3/4 x 2.5
1c + UMA 150D 7/21	23	7.5	31 (25)	17.8	76.4	0.82	4 x 2.5	3/4 x 2.5
1 + UMA 150D 9/21	25	9.0	32 (26)	20.5	77.9	0.82	4 x 2.5	3/4 x 2.5
2g + UMA 150D 13/21	34	11.0	36 (31)	25.5	80.7	0.78	4 x 2.5	3/4 x 2.5
2f + UMA 150D 13/21	37	11.5	33 (28)	26.5	80.6	0.79	4 x 2.5	3/4 x 2.5
2e + UMA 150D 13/21	39	13.0	30 (24)	29.0	80.2	0.81	4 x 2.5	3/4 x 2.5
2d + UMA 150D 15/21	42	14.0	34 (29)	30.5	82.1	0.82	4 x 4.0	3/4 x 2.5
2c + UMA 150D 15/21	44	15.0	31 (26)	32.5	81.7	0.83	4 x 4.0	3/4 x 2.5
2 + UMA 150D 18/21	48	17.0	30 (24)	38.0	82.1	0.79	4 x 4.0	3/4 x 2.5
3e + UMA 150D 18/21	58	18.5	26 (20)	40.5	81.7	0.81	4 x 4.0	3/4 x 2.5
3d + UMA 150D 22/21	63	21.0	32 (27)	46.0	83.5	0.80	4 x 4.0	3/4 x 2.5
3c + UMA 150D 22/21	66	22.0	30 (23)	47.5	83.3	0.81	4 x 4.0	3/4 x 2.5
3b + UMA 150D 26/21	70	24.0	36 (31)	52.0	84.9	0.80	4 x 6.0	3/4 x 4.0
3 + UMA 150D 26/21	72	25.0	33 (28)	53.0	84.8	0.81	4 x 6.0	3/4 x 4.0
4d + UMA 150D 30/21	84	28.0	34 (29)	61.0	84.7	0.79	4 x 6.0	3/4 x 4.0
4c + UMA 150D 30/21	89	30.0	32 (26)	65.0	84.5	0.80	4 x 6.0	3/4 x 4.0
4b + UMA 150D 30/21	92	30.0	30 (24)	65.0	84.5	0.80	4 x 6.0	3/4 x 4.0
4 + UMA 150D 37/22	96	34.0	44 (38)	74.0	84.0	0.80	3/4 x 4.0 ⁴⁾	3/4 x 4.0
5c + UMA 150D 37/22	110	37.0	40 (34)	79.0	83.6	0.82	3/4 x 4.0 ⁴⁾	3/4 x 4.0
5b + UMA 150D 37/22	114	37.0	38 (32)	79.0	83.6	0.82	3/4 x 4.0 ⁴⁾	3/4 x 4.0
5 + UMA 200D 45/21	122	44.0	30 (24)	89.0	86.0	0.84	3/4 x 6.0 ³⁾	3/4 x 6.0
6c + UMA 200D 45/21	135	45.0	28 (21)	90.0	86.0	0.84	3/4 x 6.0 ³⁾	3/4 x 6.0
6b + UMA 200D 55/21	142	48.0	32 (27)	98.0	87.2	0.82	3/4 x 6.0 ³⁾	3/4 x 6.0
6 + UMA 200D 55/21	146	52.0	30 (24)	104.0	87.1	0.83	3/4 x 6.0 ³⁾	3/4 x 6.0
7b + UMA 200D 55/21	164	55.0	27 (21)	109.0	86.9	0.84	3/4 x 6.0 ³⁾	3/4 x 6.0
7 + UMA 200D 65/21	171	60.0	31 (25)	120.0	87.8	0.83	3/4 x 10.0 ³⁾	3/4 x 10.0
8 + UMA 200D 75/21	196	70.0	27 (21)	143.0	87.4	0.81	3/4 x 10.0 ³⁾	3/4 x 10.0
9 + UMA 200D 75/21	219	75.0	23 (15)	151.0	87.3	0.83	3/4 x 10.0 ³⁾	3/4 x 10.0
10 + UMA 200D 90/21	245	86.0	27 (20)	173.0	88.1	0.82	3/4 x 16.0 ³⁾	3/4 x 16.0
11 + UMA 200D 90/21	267	90.0	23 (16)	181.0	88.0	0.82	3/4 x 16.0 ³⁾	3/4 x 16.0

¹⁾ also see pages 3 and 60. ²⁾ 3/4 = 1 x 3-core + 1 x 4-core, 90° spacing. ³⁾ Delta wiring in the cable connector or control cabinet. ⁴⁾ Parallel cable

Dimensions / Weights / Horizontal Installation ¹⁾

UPA 200B - 130/..	L _P mm	L _A ≈ mm		m _A ≈ kg		D _{max} ≈ mm		Installation ²⁾	A ≈ mm
		G (Standard)	B (Special)	G (Standard)	B (Special)	D.o.l.	Y-Δ		
1g	595	1295	1305	86	94	193	196	v + h	625
1e, 1c	595	1315	1325	88	96	193	196	v + h	635
1	595	1345	1355	91	99	193	196	v + h	650
2g, 2f, 2e	740	1570	1580	108	118	193	196	v + h	835
2d, 2c	740	1615	1625	112	122	194	196	v + h	855
2	740	1660	1670	116	126	194	196	v + h	880
3e	885	1805	1815	127	138	194	196	v + h	1025
3d, 3c	885	1895	1905	135	146	194	196	v + h	1070
3b, 3	885	2000	2010	144	156	195	198	v + h	1120
4d, 4c, 4b	1030	2245	2255	163	176	195	198	v + h	1315
4	1030	2325	2335	170	183	198	198	v ³⁾	-
5c, 5b	1175	2470	2480	181	195	198	198	v ³⁾	-
5	1175	2405	2405	236	252	201	201	v + h	1470
6c	1320	2550	2550	246	264	201	201	v + h	1615
6b, 6	1320	2660	2660	266	284	201	201	v + h	1670
7b	1465	2805	2805	277	296	201	201	v + h	1815
7	1465	2935	2935	300	319	205	205	v + h	1880
8	1610	3170	3170	326	347	205	205	v ⁴⁾	-
9	1755	3315	3315	337	359	205	205	v ⁴⁾	-
10	1900	3640	3640	380	403	211	211	v ^{3) 4)}	-
11	2045	3785	3785	390	415	211	211	v ^{3) 4)}	-

¹⁾ Including check valve with threaded end and standard motor leads. ²⁾ v = vertical and h = horizontal.
³⁾ Horizontal installation on request. ⁴⁾ Horizontal installation only with bearing pedestals of special design.

UPA 200B - 130 / ..

The characteristic curves shown are for preliminary selection only. Exact selection data will be provided in our quotation.

Selection

The characteristic curves shown apply to the standard impeller material, i.e. Noryl.

The performance data for the full impeller diameter for the given number of stages will only be achieved when the impellers are made of Noryl (PPO).

For the special impeller material (bronze), please select the next higher number of stages.

In this case, please refer to the characteristic curves individually prepared for the quotation.

The pressure losses H_v in the check valve are not considered in the pump characteristic curves.

For more details and a selection example refer to page 8.

Legend ...

- H_v : Head losses in the check valve
- η_p : Pump efficiency (not considering check valve)
- NPSH: Net positive suction head required by the pump

Pump End G 5" / DN 125

The information is based on the model "with check valve / connection branch and threaded end".

The changes in the main dimensions of the "flanged end" model are specified in the table below.

Check valve / connection branch with:

Threaded end G5"		Flanged end DN 125	
Length mm	Length mm	Outside diameter mm	
200	150 (PN 10/16) 150 (PN 25/40)	250 270	

Threaded end to DIN ISO 228, Part 1

Flange mating dimensions to DIN 2501, Part 1

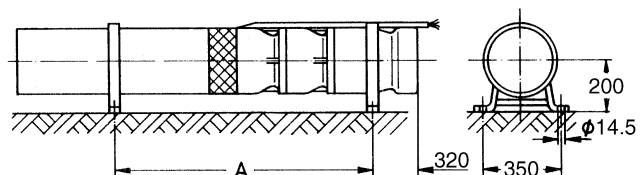
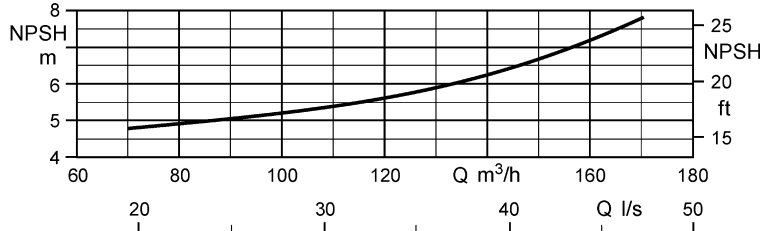
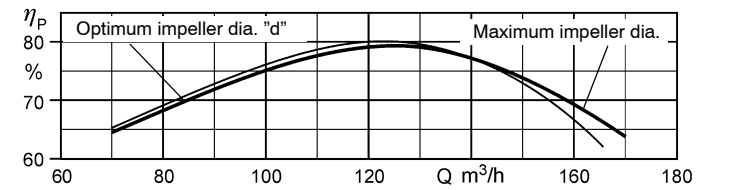
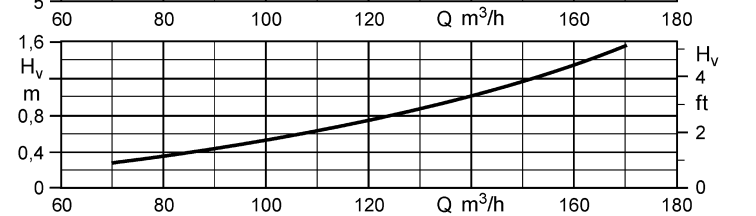
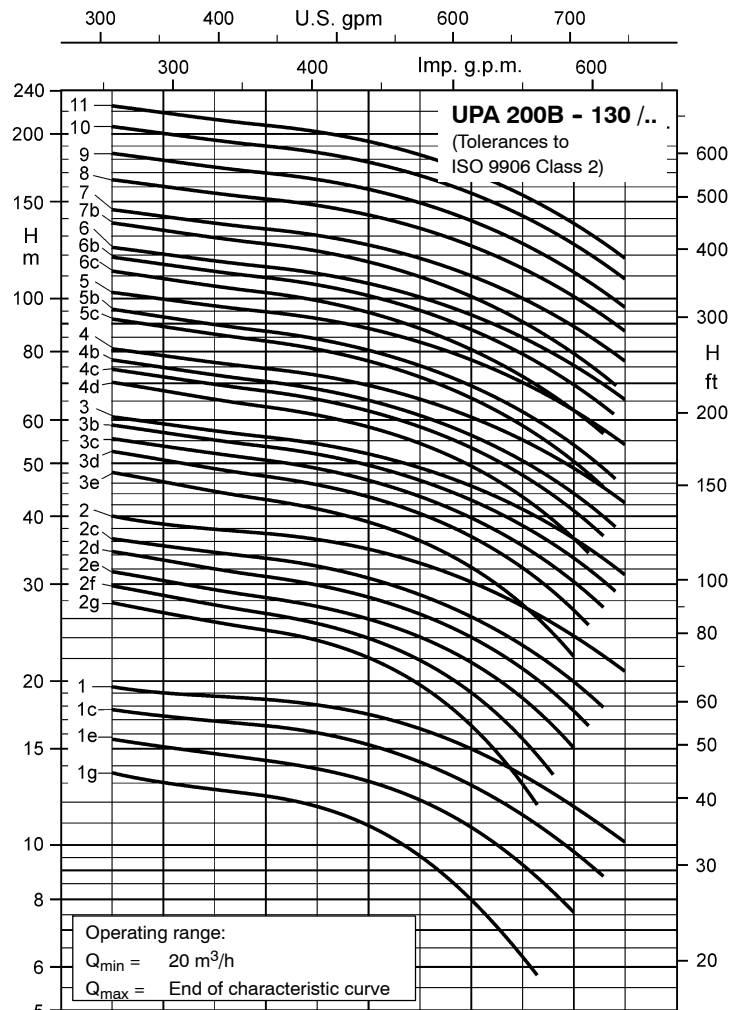
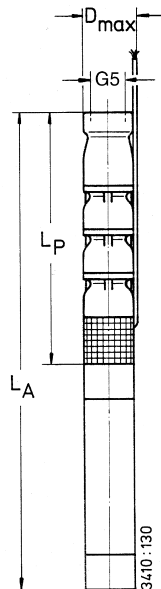

UPA 250C - 120 for Well Diameters of 250 mm (10 inches) and above

Pumps with submersible motors for **three-phase current (3~) / 400 V / d.o.l. (D) or star-delta (Y-Δ) starting**

Pump + motor	Pump		Motor				Motor lead ²⁾ , flat	
	Discharge head Q = 0 m ³ /h	Rated power	Max. temperature of the fluid pumped v ≥ 0.2 m/s (= 0 m/s)	Rated current	Efficiency	Power factor	Number x cross-section of conductors (use under water, 400 V and ≤ +30 °C)	
UPA 250C - 120/.. + ...	H _o m	P _N kW	t _{max} ¹⁾ °C	I _N A	η _M %	cos φ --	D.o.l. mm ²	Y-Δ mm ²
1l + UMA 150D 9/21	29	9.0	31 (26)	20.5	77.9	0.82	4 x 2.5	3/4 x 2.5
1k + UMA 150D 13/21	32	10.5	36 (32)	25.0	80.8	0.76	4 x 2.5	3/4 x 2.5
1g + UMA 150D 13/21	36	12.0	32 (27)	27.0	80.5	0.80	4 x 2.5	3/4 x 2.5
1d + UMA 150D 15/21	40	14.0	33 (28)	30.5	82.1	0.82	4 x 4.0	3/4 x 2.5
1 + UMA 150D 18/21	43	16.5	32 (26)	37.0	82.2	0.79	4 x 4.0	3/4 x 2.5
2l + UMA 150D 18/21	57	18.0	28 (21)	39.5	81.8	0.81	4 x 4.0	3/4 x 2.5
2k + UMA 150D 22/21	62	21.0	32 (26)	46.0	83.5	0.80	4 x 4.0	3/4 x 2.5
2h + UMA 150D 26/21	68	24.0	35 (30)	52.0	84.9	0.80	4 x 6.0	3/4 x 4.0
2f + UMA 150D 26/21	72	26.0	32 (27)	55.0	84.6	0.82	4 x 6.0	3/4 x 4.0
2d + UMA 150D 30/21	79	29.0	32 (26)	63.0	84.6	0.80	4 x 6.0	3/4 x 4.0
2 + UMA 150D 37/22	84	34.0	43 (38)	74.0	84.0	0.80	3/4 x 4.0 ⁴⁾	3/4 x 4.0
3h + UMA 150D 37/22	99	35.0	42 (36)	76.0	83.9	0.80	3/4 x 4.0 ⁴⁾	3/4 x 4.0
3f + UMA 150D 37/22	106	37.0	38 (32)	79.0	83.6	0.82	3/4 x 4.0 ⁴⁾	3/4 x 4.0
3e + UMA 200D 45/21	113	42.0	31 (25)	85.0	86.1	0.83	3/4 x 6.0 ³⁾	3/4 x 6.0
3c + UMA 200D 45/21	122	45.0	27 (20)	90.0	86.0	0.84	3/4 x 6.0 ³⁾	3/4 x 6.0
3 + UMA 200D 55/21	125	52.0	30 (24)	104.0	87.1	0.83	3/4 x 6.0 ³⁾	3/4 x 6.0
4f + UMA 200D 55/21	145	54.0	29 (23)	108.0	87.0	0.84	3/4 x 6.0 ³⁾	3/4 x 6.0
4d + UMA 200D 65/21	158	60.0	31 (25)	120.0	87.8	0.83	3/4 x 10.0 ³⁾	3/4 x 10.0
4 + UMA 200D 75/21	168	70.0	27 (21)	143.0	87.4	0.81	3/4 x 10.0 ³⁾	3/4 x 10.0
5e + UMA 200D 75/21	189	70.0	27 (21)	143.0	87.4	0.81	3/4 x 10.0 ³⁾	3/4 x 10.0
5c + UMA 200D 75/21	203	75.0	22 (14)	151.0	87.3	0.83	3/4 x 10.0 ³⁾	3/4 x 10.0
5 + UMA 200D 90/21	209	86.0	27 (20)	173.0	88.1	0.82	3/4 x 16.0 ³⁾	3/4 x 16.0
6c + UMA 250D 110/21	247	95.0	27 (20)	191.0	88.7	0.81	3/4 x 25.0 ³⁾	3/4 x 25.0
6 + UMA 250D 110/21	251	105.0	23 (15)	208.0	88.6	0.83	3/4 x 25.0 ³⁾	3/4 x 25.0
7 + UMA 250D 132/21	293	120.0	24 (16)	229.0	89.2	0.85	3/4 x 25.0 ³⁾	3/4 x 25.0
8 + UMA 250D 160/21	335	140.0	24 (16)	268.0	89.5	0.85	3/4 x 25.0 ⁴⁾	3/4 x 35.0 ⁵⁾
9 + UMA 250D 190/21	380	155.0	25 (17)	309.0	90.0	0.81	3/4 x 35.0 ⁴⁾ 5)	3/4 x 50.0 ⁵⁾
10 + UMA 250D 190/21	420	175.0	20 (11)	341.0	89.9	0.83	3/4 x 35.0 ⁴⁾ 5)	3/4 x 50.0 ⁵⁾
11 + UMA 300D 250/22	471	195.0	58 (52)	366.0	90.6	0.85	2x3x70 + 1x35 ⁴⁾ 6)	2x3x70 + 1x35 ⁶⁾
12 + UMA 300D 250/22	513	215.0	56 (50)	398.0	90.7	0.86	2x3x70 + 1x35 ⁴⁾ 6)	2x3x70 + 1x35 ⁶⁾

1) also see pages 3 and 60.

3) Delta wiring in the cable connector or control cabinet..

5) 1 x 3-core, flat and 1 x 4-core, round

2) 3/4 = 1 x 3-core + 1 x 4-core, 90° spacing.

4) Parallel cable

6) 2 x 3-core, flat and 1 x 1-core, round

Dimensions / Weights / Horizontal Installation ¹⁾

UPA 250C - 120/..	L _p mm	L _A ≈ mm		m _A ≈ kg		D _{max} ≈ mm		Installation ²⁾	A ≈ mm
		G (Standard)	B (Special)	G (Standard)	B (Special)	D.o.l.	Y-Δ		
1l	681	1430	1445	115	128	230	232	v + h	710
1k, 1g	681	1510	1525	122	135	230	232	v + h	750
1d	681	1555	1570	126	139	230	232	v + h	775
1	681	1600	1615	130	143	230	232	v + h	795
2l	828	1745	1760	150	167	230	232	v + h	945
2k	828	1835	1850	158	175	230	232	v + h	990
2h, 2f	828	1940	1955	167	185	232	233	v + h	1040
2d	828	2040	2055	176	193	232	233	v + h	1090
2	828	2120	2135	183	200	233	233	v ³⁾	-
3h, 3f	975	2270	2280	203	225	233	233	v ³⁾	-
3e, 3c	975	2205	2205	258	282	235	235	v + h	1245
3	975	2315	2315	278	302	235	235	v + h	1300
4f	1122	2465	2465	298	326	235	235	v + h	1450
4d	1122	2595	2595	321	349	239	239	v + h	1515
4	1122	2685	2685	337	365	239	239	v + h	1560
5e, 5c	1269	2830	2830	357	389	239	239	v + h	1705
5	1269	3010	3010	389	421	244	244	v ³⁾ 4)	-
6c, 6	1416	2945	2945	479	514	257	257	v + h	1835
7	1563	3220	3220	544	583	257	257	v ⁴⁾	-
8	1710	3480	3480	601	644	257	266	v ⁴⁾	-
9	1857	3775	3775	672	719	266	280	v ³⁾ 4)	-
10	2004	3925	3925	692	744	266	280	v ³⁾ 4)	-
11	2151	4225	4225	837	891	304	304	v ⁴⁾	-
12	2298	4370	4370	857	915	304	304	v ⁴⁾	-

1) Including check valve with threaded end and standard motor leads.

2) v = vertical and h = horizontal.

3) Horizontal installation on request.

4) Horizontal installation only with bearing pedestals of special design.

UPA 250C - 120 / ..

The characteristic curves shown are for preliminary selection only. Exact selection data will be provided in our quotation.

Selection

The pressure losses H_v in the check valve are not considered in the pump characteristic curves.

For more details and a selection example refer to page 8.

Legend ...

- H_v : Head losses in the check valve
- η_p : Pump efficiency (not considering check valve)
- NPSH: Net positive suction head required by the pump

Pump End G 6" / DN 150

The information is based on the model "with check valve / connection branch and threaded end".

The changes in the main dimensions of the "flanged end" model are specified in the table below.

Check valve / connection branch with:

Threaded end G6"	Flanged end DN 150	
	Length mm	Outside diameter mm
229	179 (PN 10/16) 179 (PN 25/40)	285 300

Threaded end to DIN ISO 228, Part 1

Flange mating dimensions to DIN 2501, Part 1

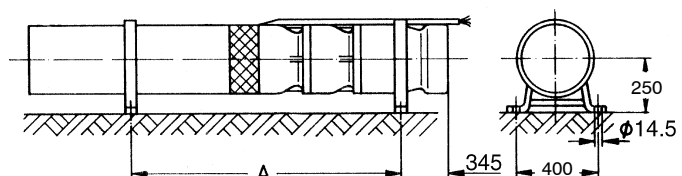
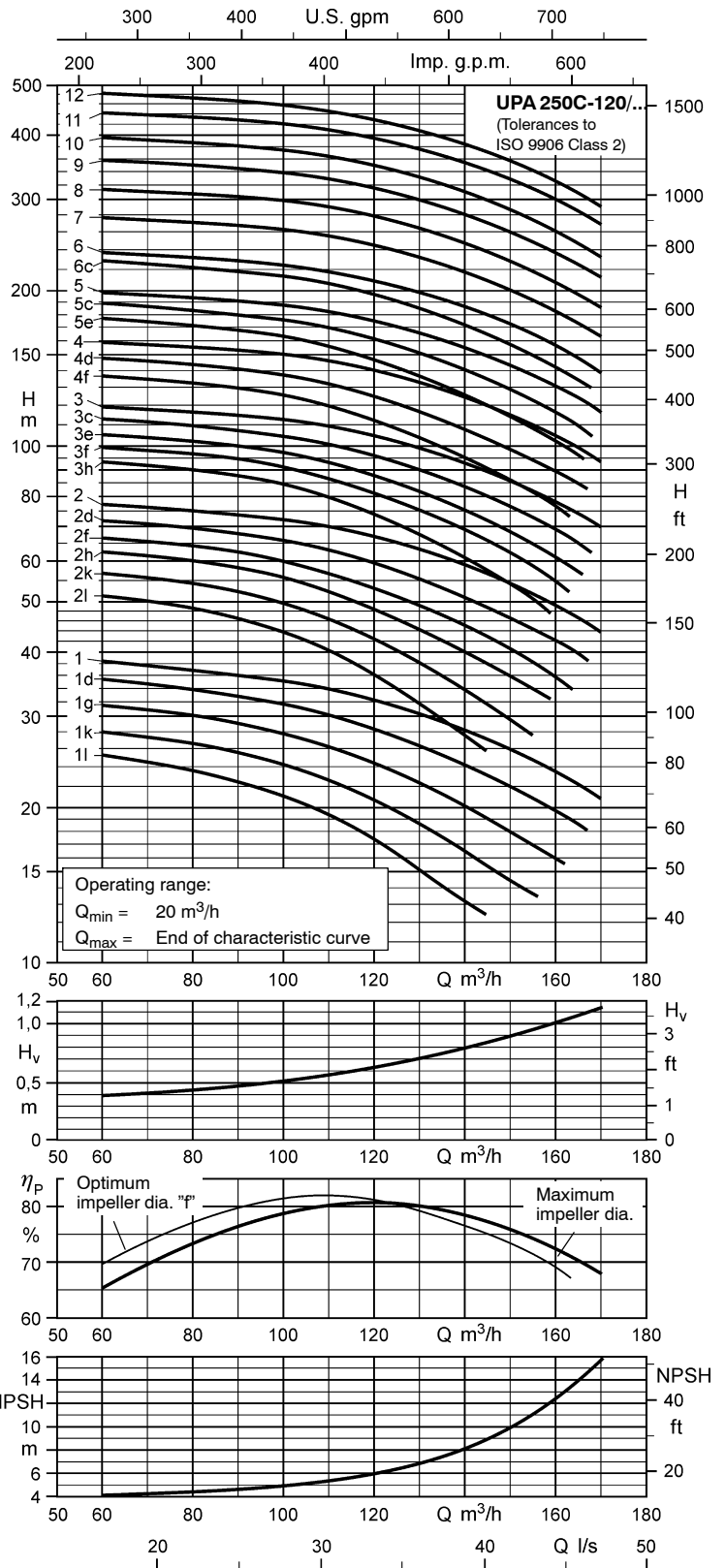
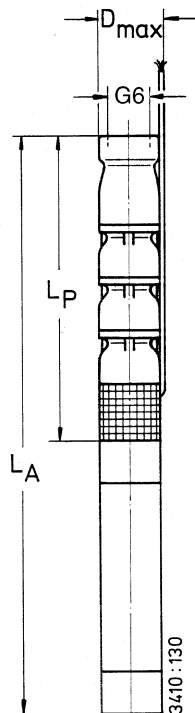

UPA 250C -150 for Well Diameters of 250 mm (10 inches) and above

Pumps with submersible motors for **three-phase current (3~) / 400 V / d.o.l. (D) or star-delta (Y-Δ) starting**

Pump + motor	Pump		Motor				Motor lead ²⁾ , flat	
	Discharge head Q = 0 m ³ /h	Rated power	Max. temperature of the fluid pumped v ≥ 0.2 m/s (= 0 m/s)	Rated current	Efficiency	Power factor	Number x cross-section of conductors (use under water, 400 V and ≤ +30 °C)	
UPA 250C - 150/.. + ...	H ₀ m	P _N kW	t _{max} ¹⁾ °C	I _N A	η _M %	cos φ --	D.o.l. mm ²	Y-Δ mm ²
1l + UMA 150D 13/21	27	11.0	35 (30)	25.5	80.7	0.78	4 x 2.5	3/4 x 2.5
1k + UMA 150D 15/21	32	14.0	34 (29)	30.5	82.1	0.82	4 x 4.0	3/4 x 2.5
1d + UMA 150D 18/21	38	18.5	27 (20)	40.5	81.7	0.81	4 x 4.0	3/4 x 2.5
1 + UMA 150D 22/21	41	22.0	30 (24)	47.5	83.3	0.81	4 x 4.0	3/4 x 2.5
2k + UMA 150D 30/21	64	28.0	34 (28)	61.0	84.7	0.79	4 x 6.0	3/4 x 4.0
2h + UMA 150D 30/21	68	30.0	30 (24)	65.0	84.5	0.80	4 x 6.0	3/4 x 4.0
2f + UMA 150D 37/22	73	34.0	43 (37)	74.0	84.0	0.80	3/4 x 4.0 ⁴⁾	3/4 x 4.0
2c + UMA 150D 37/22	77	37.0	39 (32)	79.0	83.6	0.82	3/4 x 4.0 ⁴⁾	3/4 x 4.0
2 + UMA 200D 45/21	82	44.0	28 (22)	89.0	86.0	0.84	3/4 x 6.0 ³⁾	3/4 x 6.0
3h + UMA 200D 45/21	99	45.0	27 (20)	90.0	86.0	0.84	3/4 x 6.0 ³⁾	3/4 x 6.0
3g + UMA 200D 55/21	105	50.0	31 (25)	101.0	87.2	0.83	3/4 x 6.0 ³⁾	3/4 x 6.0
3d + UMA 200D 55/21	112	55.0	27 (20)	109.0	86.9	0.84	3/4 x 6.0 ³⁾	3/4 x 6.0
3b + UMA 200D 65/21	118	62.0	30 (24)	123.0	87.7	0.83	3/4 x 10.0 ³⁾	3/4 x 10.0
3 + UMA 200D 65/21	121	65.0	27 (20)	129.0	87.7	0.84	3/4 x 10.0 ³⁾	3/4 x 10.0
4e + UMA 200D 75/21	146	72.0	26 (19)	146.0	87.4	0.82	3/4 x 10.0 ³⁾	3/4 x 10.0
4c + UMA 200D 75/21	152	75.0	22 (15)	151.0	87.3	0.83	3/4 x 10.0 ³⁾	3/4 x 10.0
4b + UMA 200D 90/21	158	82.0	28 (21)	167.0	88.2	0.81	3/4 x 16.0 ³⁾	3/4 x 16.0
4 + UMA 200D 90/21	162	88.0	25 (18)	177.0	88.1	0.82	3/4 x 16.0 ³⁾	3/4 x 16.0
5c + UMA 250D 110/21	192	100.0	25 (18)	199.0	88.6	0.82	3/4 x 25.0 ³⁾	3/4 x 25.0
5b + UMA 250D 110/21	197	105.0	23 (15)	208.0	88.6	0.83	3/4 x 25.0 ³⁾	3/4 x 25.0
5 + UMA 250D 110/21	202	110.0	19 (10)	215.0	88.5	0.84	3/4 x 25.0 ³⁾	3/4 x 25.0
6c + UMA 250D 132/21	230	120.0	25 (18)	229.0	89.2	0.85	3/4 x 25.0 ³⁾	3/4 x 25.0
6b + UMA 250D 132/21	236	125.0	23 (14)	237.0	89.1	0.86	3/4 x 25.0 ³⁾	3/4 x 25.0
6 + UMA 250D 132/21	241	132.0	19 (10)	249.0	89.0	0.86	3/4 x 25.0 ³⁾	3/4 x 25.0
7b + UMA 250D 160/21	275	145.0	21 (12)	276.0	89.4	0.85	3/4 x 25.0 ⁴⁾	3/4 x 35.0 ⁵⁾
7 + UMA 250D 190/21	286	160.0	24 (16)	317.0	90.0	0.81	3/4 x 35.0 ^{4) 5)}	3/4 x 50.0 ⁵⁾
8 + UMA 250D 190/21	325	180.0	18 (8)	349.0	89.8	0.83	3/4 x 35.0 ^{4) 5)}	3/4 x 50.0 ⁵⁾
9 + UMA 300D 250/22	373	210.0	57 (51)	389.0	90.7	0.86	2x3x70 + 1x35 ^{4) 6)}	2x3x70 + 1x35 ⁶⁾
10 + UMA 300D 250/22	413	230.0	55 (48)	424.0	90.7	0.87	2x3x70 + 1x35 ^{4) 6)}	2x3x70 + 1x35 ⁶⁾
11 + UMA 300D 250/22	453	250.0	52 (45)	458.0	90.7	0.87	2x3x70 + 1x35 ^{4) 6)}	2x3x70 + 1x35 ⁶⁾

1) also see pages 3 and 60.

2) 3/4 = 1 x 3-core + 1 x 4-core, 90° spacing.

3) Delta wiring in the cable connector or control cabinet.

4) Parallel cable

5) 1 x 3-core, flat and 1 x 4-core, round

6) 2 x 3-core, flat and 1 x 1-core, round

Dimensions / Weights / Horizontal Installation ¹⁾

UPA 250C - 150/..	L _p mm	L _A ≈ mm		m _A ≈ kg		D _{max} ≈ mm		Installation ²⁾	A ≈ mm
		G (Standard)	B (Special)	G (Standard)	B (Special)	D.o.l.	Y-Δ		
1l	690	1520	1530	120	133	230	232	v + h	755
1k	690	1565	1575	124	137	230	232	v + h	775
1d	690	1610	1620	128	141	230	232	v + h	800
1	690	1700	1710	136	149	230	232	v + h	845
2k, 2h	846	2060	2075	173	189	232	233	v + h	1105
2f, 2c	846	2140	2155	180	196	233	233	v ³⁾	-
2	846	2075	2075	235	253	235	235	v + h	1110
3h	1002	2235	2235	254	275	235	235	v + h	1270
3g, 3d	1002	2345	2345	274	295	235	235	v + h	1325
3b, 3	1002	2475	2475	297	318	239	239	v + h	1390
4e, 4c	1158	2720	2720	332	356	239	239	v + h	1590
4b, 4	1158	2900	2900	364	388	244	244	v ³⁾	-
5c, 5b, 5	1314	2845	2845	452	479	257	257	v + h	1730
6c, 6b, 6	1470	3130	3130	515	546	257	257	v ⁴⁾	-
7b	1626	3395	3395	571	605	257	266	v ⁴⁾	-
7	1626	3545	3545	622	656	266	280	v ^{3) 4)}	-
8	1782	3700	3700	641	678	266	280	v ^{3) 4)}	-
9	1938	4010	4010	785	823	304	304	v ⁴⁾	-
10	2094	4165	4165	804	845	304	304	v ⁴⁾	-
11	2250	4325	4325	822	867	304	304	v ⁴⁾	-

1) Including check valve with threaded end and standard motor leads.

3) Horizontal installation on request.

2) v = vertical and h = horizontal.

4) Horizontal installation only with bearing pedestals of special design.

UPA 250C - 150 / ..

The characteristic curves shown are for preliminary selection only. Exact selection data will be provided in our quotation.

Selection

The pressure losses H_v in the check valve are not considered in the pump characteristic curves. For more details and a selection example refer to page 8.

Legend ...

- H_v : Head losses in the check valve
- η_p : Pump efficiency (not considering check valve)
- NPSH: Net positive suction head required by the pump

Pump End G 6" / DN 150

The information is based on the model "with check valve / connection branch and threaded end".

The changes in the main dimensions of the "flanged end" model are specified in the table below.

Check valve / connection branch with:

Threaded end G 6"		Flanged end DN 150	
Length mm	Length mm	Outside diameter mm	
229	179 (PN 10/16)	285	
	179 (PN 25/40)	300	

Threaded end to DIN ISO 228, Part 1.

Flange mating dimensions to DIN 2501, Part 1

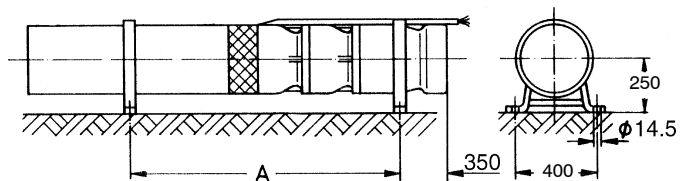
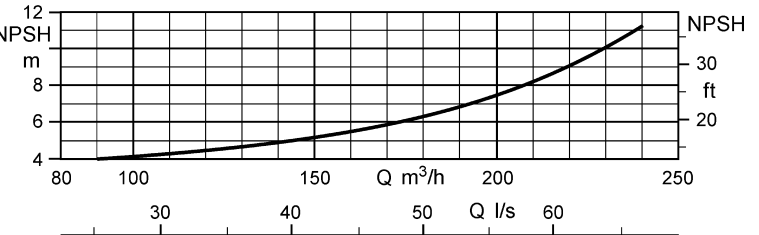
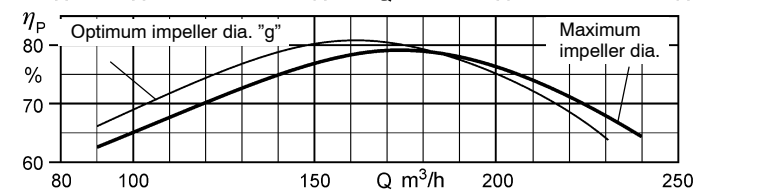
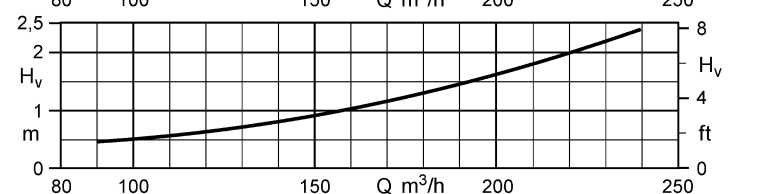
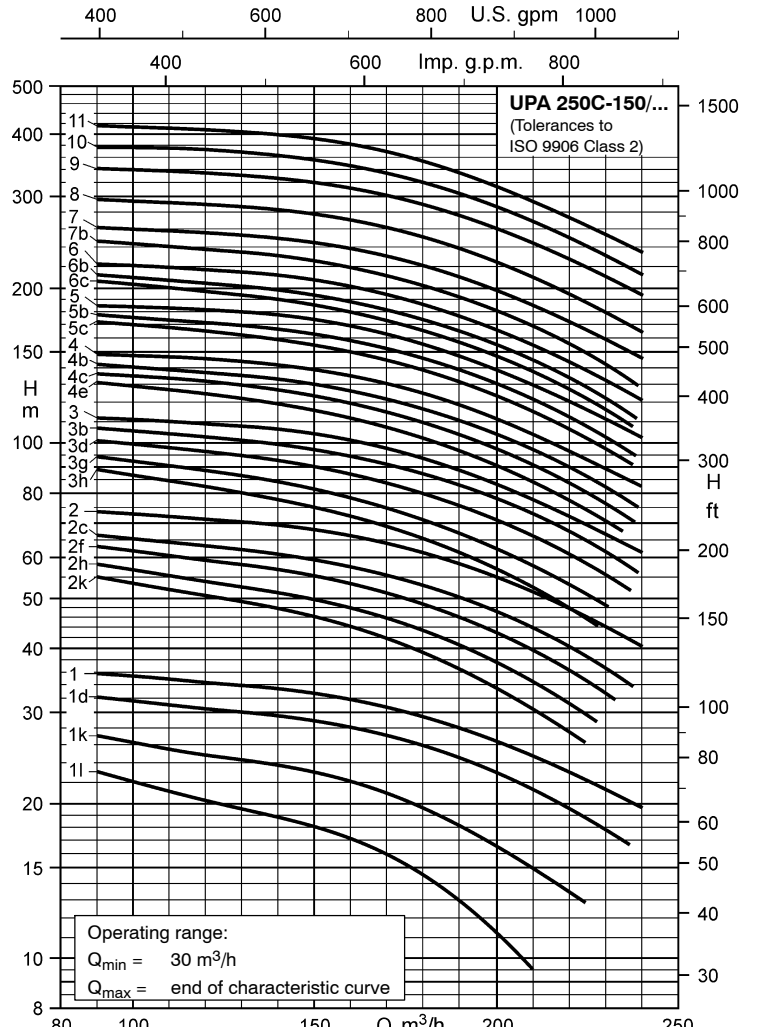
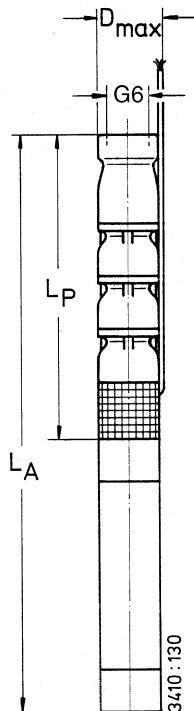

UPA 250C - 250 for Well Diameters of 250 mm (10 inches) and above

Pumps with submersible motors for **three-phase current (3~) / 400 V / d.o.l. (D) or star-delta (Y-Δ) starting**

Pump + motor	Pump		Motor				Motor lead ²⁾ , flat	
	Discharge head Q = 0 m ³ /h	Rated power	Max. temperature of the fluid pumped v ≥ 0.2 m/s (= 0 m/s)	Rated current	Efficiency	Power factor	Number x cross-section of conductors (use under water, 400 V and ≤ +30 °C)	
UPA 250C - 250/.. + ...	H ₀ m	P _N kW	t _{max} ¹⁾ °C	I _N A	η _M %	cos φ --	D.o.l. mm ²	Y-Δ mm ²
1m + UMA 150D 18/21	26	17.0	31 (25)	38.0	82.1	0.79	4 x 4.0	3/4 x 2.5
1k + UMA 150D 18/21	29	18.5	27 (20)	40.5	81.7	0.81	4 x 4.0	3/4 x 2.5
1f + UMA 150D 22/21	32	21.0	32 (26)	46.0	83.5	0.80	4 x 4.0	3/4 x 2.5
1 + UMA 150D 26/21	38	26.0	33 (27)	55.0	84.6	0.82	4 x 6.0	3/4 x 4.0
2m + UMA 150D 37/22	51	33.0	45 (39)	72.0	84.1	0.79	3/4 x 4.0 ⁴⁾	3/4 x 4.0
2l + UMA 150D 37/22	55	35.0	42 (36)	76.0	83.9	0.80	3/4 x 4.0 ⁴⁾	3/4 x 4.0
2g + UMA 150D 37/22	60	37.0	38 (32)	79.0	83.6	0.82	3/4 x 4.0 ⁴⁾	3/4 x 4.0
2d + UMA 200D 45/21	70	45.0	27 (20)	90.0	86.0	0.84	3/4 x 6.0 ³⁾	3/4 x 6.0
2 + UMA 200D 55/21	75	52.0	30 (24)	104.0	87.1	0.83	3/4 x 6.0 ³⁾	3/4 x 6.0
3h + UMA 200D 55/21	87	55.0	27 (20)	109.0	86.9	0.84	3/4 x 6.0 ³⁾	3/4 x 6.0
3f + UMA 200D 65/21	94	62.0	30 (24)	123.0	87.7	0.83	3/4 x 10.0 ³⁾	3/4 x 10.0
3d + UMA 200D 75/21	103	68.0	28 (21)	140.0	87.5	0.81	3/4 x 10.0 ³⁾	3/4 x 10.0
3 + UMA 200D 75/21	109	75.0	24 (16)	151.0	87.3	0.83	3/4 x 10.0 ³⁾	3/4 x 10.0
4g + UMA 200D 75/21	120	75.0	22 (15)	151.0	87.3	0.83	3/4 x 10.0 ³⁾	3/4 x 10.0
4e + UMA 200D 90/21	131	86.0	27 (20)	173.0	88.1	0.82	3/4 x 16.0 ³⁾	3/4 x 16.0
4c + UMA 250D 110/21	142	95.0	26 (19)	191.0	88.7	0.81	3/4 x 25.0 ³⁾	3/4 x 25.0
4 + UMA 250D 110/21	147	105.0	24 (16)	208.0	88.6	0.83	3/4 x 25.0 ³⁾	3/4 x 25.0
5e + UMA 250D 110/21	164	110.0	21 (12)	215.0	88.5	0.84	3/4 x 25.0 ³⁾	3/4 x 25.0
5c + UMA 250D 132/21	176	120.0	25 (17)	229.0	89.2	0.85	3/4 x 25.0 ³⁾	3/4 x 25.0
5 + UMA 250D 132/21	182	125.0	22 (13)	237.0	89.1	0.86	3/4 x 25.0 ³⁾	3/4 x 25.0
6d + UMA 250D 132/21	204	132.0	18 (8)	249.0	89.0	0.86	3/4 x 25.0 ³⁾	3/4 x 25.0
6 + UMA 250D 160/21	218	150.0	19 (9)	284.0	89.3	0.86	3/4 x 25.0 ⁴⁾	3/4 x 35 ⁵⁾
7c + UMA 250D 190/21	248	170.0	22 (13)	333.0	89.9	0.82	3/4 x 35 ⁴⁾ ⁵⁾	3/4 x 50 ⁵⁾
7 + UMA 250D 190/21	256	180.0	19 (9)	349.0	89.8	0.83	3/4 x 35 ⁴⁾ ⁵⁾	3/4 x 50 ⁵⁾
8c + UMA 300D 250/22	288	195.0	58 (52)	366.0	90.6	0.85	2x3x70 + 1x35 ⁴⁾ ⁶⁾	2x3x70 + 1x35 ⁶⁾
8 + UMA 300D 250/22	299	210.0	57 (51)	389.0	90.7	0.86	2x3x70 + 1x35 ⁴⁾ ⁶⁾	2x3x70 + 1x35 ⁶⁾
9 + UMA 300D 250/22	335	235.0	54 (48)	430.0	90.7	0.87	2x3x70 + 1x35 ⁴⁾ ⁶⁾	2x3x70 + 1x35 ⁶⁾
10 + UMA 300D 300/22	374	260.0	56 (50)	482.0	91.2	0.86	6x1x95 + 1x95 ⁴⁾ ⁷⁾	6x1x95 + 1x95 ⁷⁾

¹⁾ also see pages 3 and 60.

³⁾ Delta wiring in the cable connector or control cabinet..

⁵⁾ 1 x 3-core, flat and 1 x 4-core, round

²⁾ 3/4 = 1 x 3-core + 1 x 4-core, 90° spacing.

⁴⁾ Parallel cable

⁶⁾ 2 x 3-core, flat and 1 x 1-core, round

⁷⁾ 7 x 1-core. round

Dimensions / Weights / Horizontal Installation ¹⁾

UPA 250C- 250/..	L _p mm	L _A ≈ mm		m _A ≈ kg		D _{max} ≈ mm		Installation ²⁾	A ≈ mm
		G (Standard)	B (Special)	G (Standard)	B (Special)	D.o.l.	Y-Δ		
1m, 1k	709	1630	1640	128	137	230	232	v + h	800
1f	709	1720	1730	136	145	230	232	v + h	845
1	709	1825	1835	145	155	232	233	v + h	895
2m, 2l, 2g	884	2180	2190	180	192	233	233	v ³⁾	-
2d	884	2115	2115	235	249	235	235	v + h	1130
2	884	2225	2225	255	269	235	235	v + h	1185
3h	1059	2400	2400	274	291	235	235	v + h	1360
3f	1059	2530	2530	297	314	239	239	v + h	1425
3d, 3	1059	2620	2620	313	330	239	239	v + h	1470
4g	1234	2795	2795	332	353	239	239	v + h	1645
4e	1234	2975	2975	364	385	244	244	v ³⁾	-
4c, 4	1234	2765	2765	434	454	257	257	v + h	1630
5e	1409	2940	2940	453	476	257	257	v + h	1805
5c, 5	1409	3070	3070	497	520	257	257	v ⁴⁾	-
6d	1584	3245	3245	516	542	257	257	v ⁴⁾	-
6	1584	3355	3355	553	579	257	266	v ⁴⁾	-
7c, 7	1759	3680	3680	623	652	266	280	v ³⁾ ⁴⁾	-
8c, 8	1934	4005	4005	767	798	304	304	v ⁴⁾	-
9	2109	4180	4180	786	820	304	304	v ⁴⁾	-
10	2284	4535	4535	883	920	282	282	v ⁴⁾	-

¹⁾ Including check valve with threaded end and standard motor leads.

³⁾ Horizontal installation on request.

²⁾ v = vertical and h = horizontal.

⁴⁾ Horizontal installation only with bearing pedestals of special design.

UPA 250C - 250 / ..

The characteristic curves shown are for preliminary selection only. Exact selection data will be provided in our quotation.

Selection

The pressure losses H_v in the check valve are not considered in the pump characteristic curves. For more details and a selection example refer to page 8.

Legend ...

- H_v : Head losses in the check valve.
- η_p : Pump efficiency (not considering check valve)
- NPSH: Net positive suction head required by the pump.

Pump End G 6" / DN 150

The information is based on the model "with check valve / connection branch and threaded end".

The changes in the main dimensions of the "flanged end" model are specified in the table below.

Check valve / connection branch with:

Threaded end G 6"		Flanged end DN 150	
Length mm	Length mm	Outside diameter mm	
229	179 (PN 10/16) 179 (PN 25/40)	285	300

Threaded end to DIN ISO 228, Part 1

Flange mating dimensions to DIN 2501, Part 1

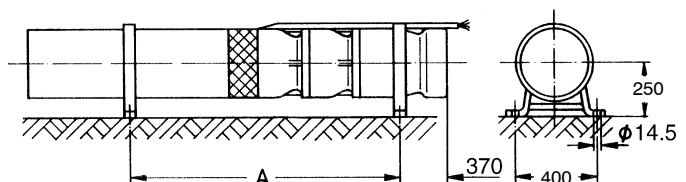
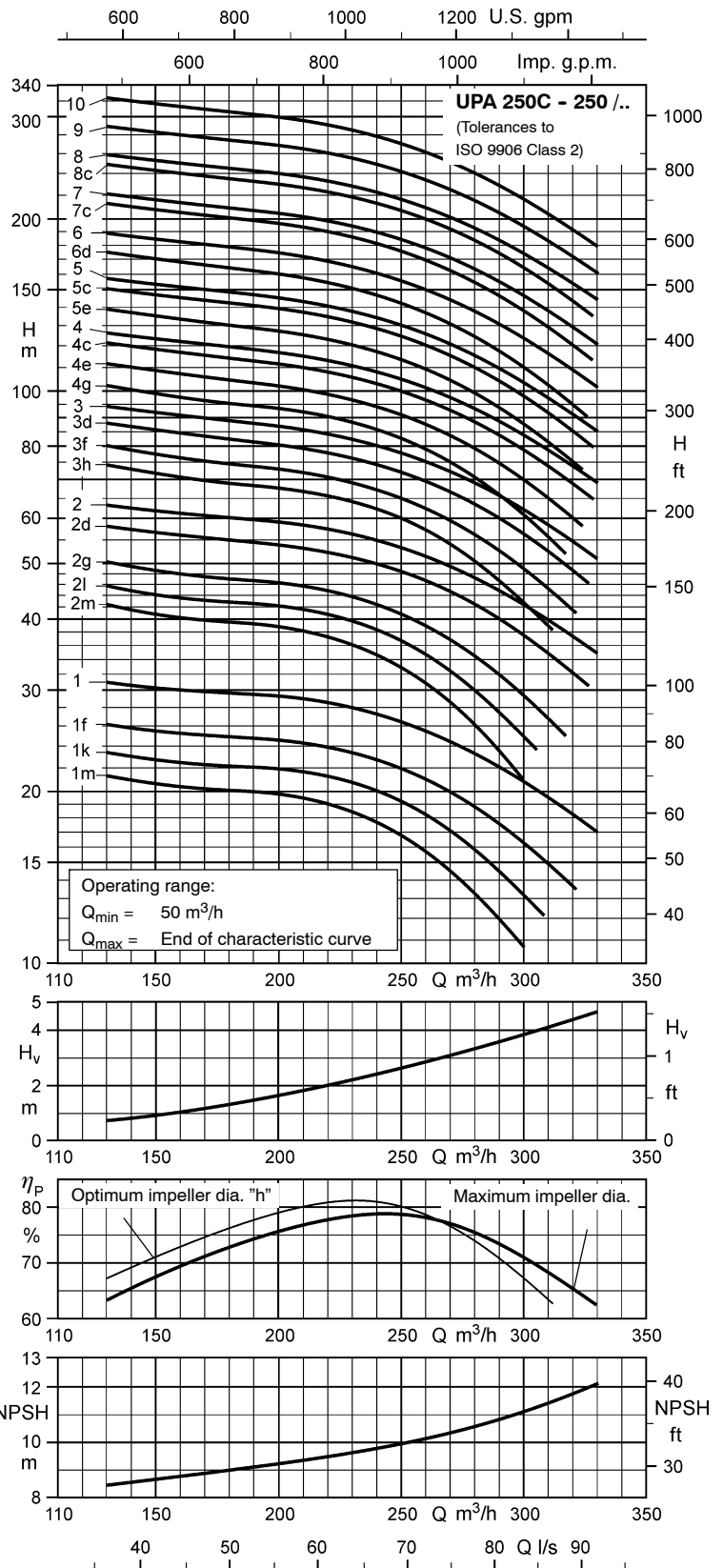
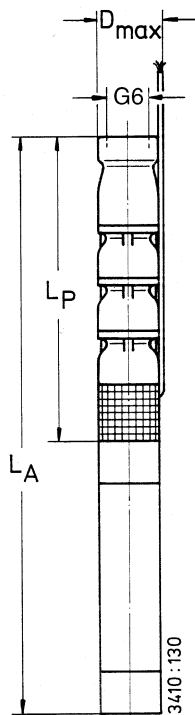

Fields of Application

Handling clean or slightly contaminated water in applications such as:

- general water supply,
- irrigation and spray irrigation,
- pressure boosting,
- lowering and maintaining ground water levels as well as
- drainage.

Also used in mining, sprinkler installations, fountains etc.

Permissible sand content in the fluid handled: 50 g/m³.

Also suitable for aggressive seawater if supplied in material variant C3 (duplex).

Operating Data

Capacity	Q up to 840 m ³ /h (234 l/s)
Head	H up to 480 m
Temperature of fluid handled	t up to +50 °C
Speed	n ≈ 2900 rpm

Design

Single or multistage, single-entry centrifugal pump in ring-section design. For vertical and horizontal installation. Mixed flow hydraulic systems with impellers that can be turned down. Stage casings are connected by means of stud bolts.

Suction casing fitted between pump and motor. Suction casing equipped with strainer to protect the pump from coarse particles in the fluid.

Pumps with check valve or connection branch on option. Both models with threaded or flanged end.

Particularly suitable for vertical installation in narrow deep wells.

Designation (Example)

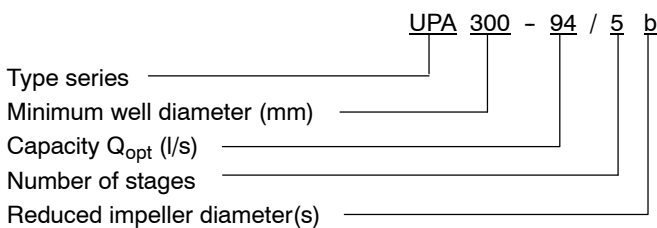

Certification

Quality management certified to ISO 9001

Submersible Borehole Pumps for well diameters of 300 mm (12 inches) and above and of 350 mm (14 inches) and above



Available automation products:

- Hyamaster
 - hyatronic
 - switch gear
- (for UPA 350)

Product Features

- Very sturdy design
- Suitable for installation in narrow deep wells
- High efficiency
- Motor designed for maximum pump output
- Low noise level
- For vertical or horizontal installation
- Check valve protected against blocking
- Pre-filled motor; no risk of contamination of the pumped water

Selection Charts (Ranges on Offer)

$n \approx 2900$ rpm

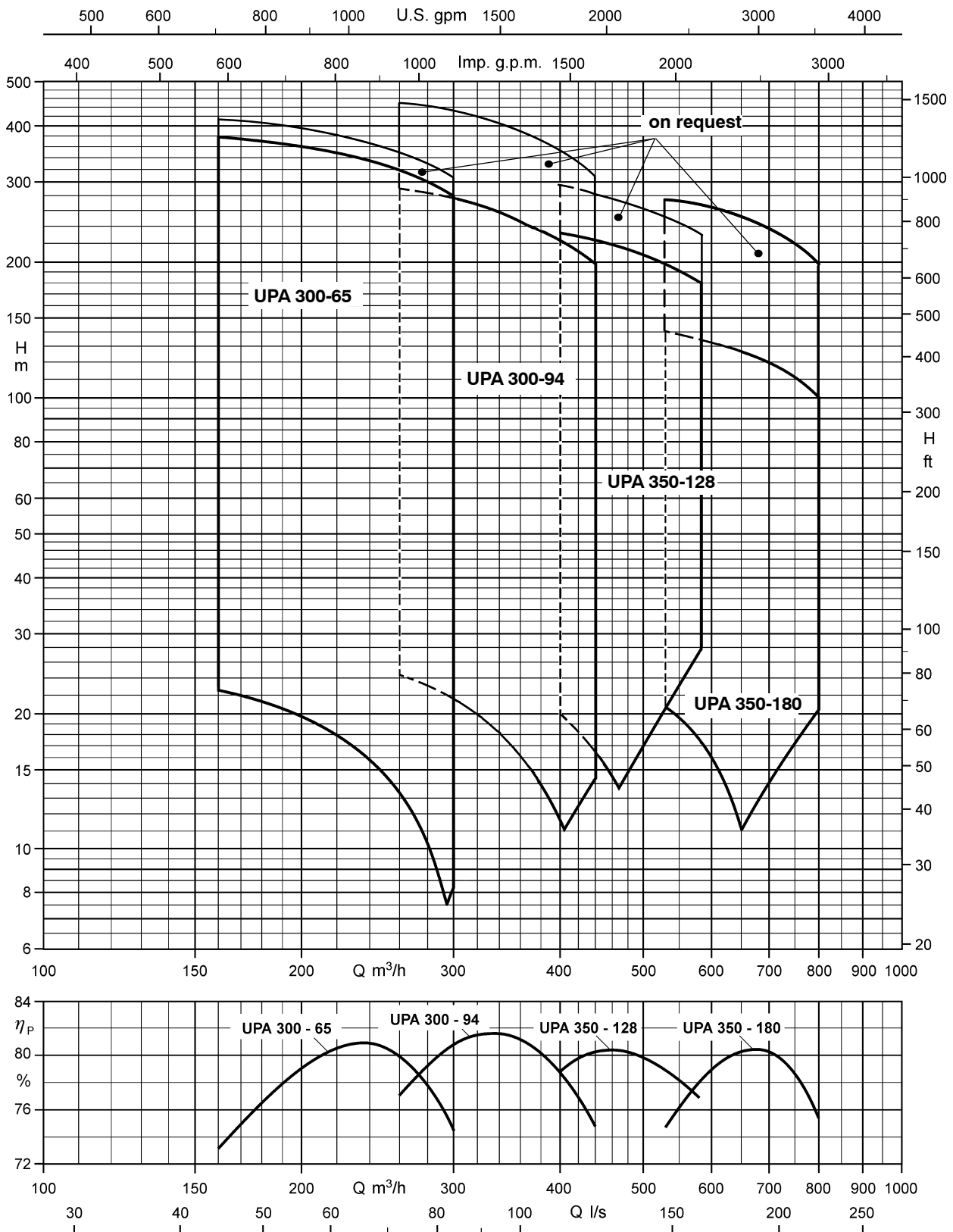

Note: The diagram shows the ΔQ_A range on offer. The pumps can be offered for any duty point within this range. The ΔQ_B operating ranges of the individual pump sizes are given in the characteristic curves for different stage numbers on the following pages. **Selection charts or performance curves for UPA in material variant C3 (duplex) in request only.**

Design Features

Check valve with anti-blockage valve disc

- No jamming or tilting.
- Spring-loaded design makes for minimum valve closing times and prevents waterhammer.
- High operating reliability.

Robust wear rings

- Replaceable wear rings made of corrosion- and wear-resistant metal.
- Protection against wear in the clearance; easy servicing.

Stainless steel union elements

- All wetted bolts, screws and nuts are made of CrNiMo steel.
- High operating reliability.
- Easy to remove and re-use even after many years of operation.

Wear-resistant mechanical seal

- Long service life and high operating reliability.

Counter thrust bearing

- Reliable balancing of negative axial thrust.
- Impellers do not rub on the stage casings.

Tried and tested thrust bearing

- Water-lubricated self-aligning tilting-pad journal bearing.
- No-maintenance design suitable for maximum load-carrying capacity under continuous operation conditions.
- New materials combination (stainless steel / carbon) for high safety factor.

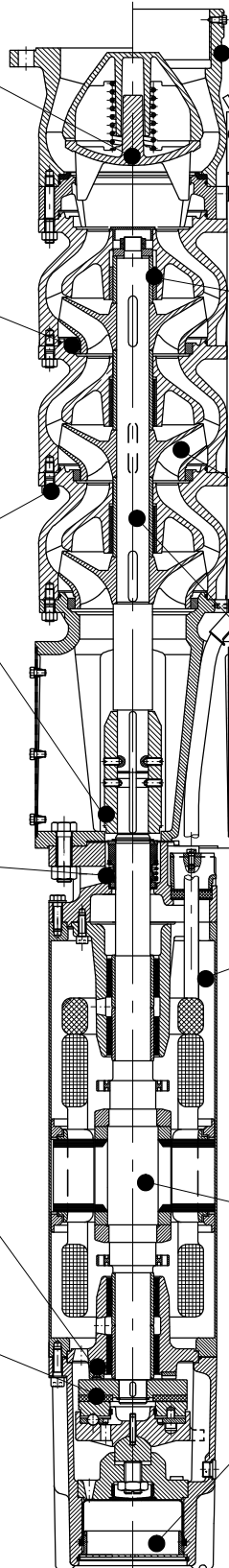

All wetted plastic components are approved for drinking water contact (BAM 1)

- Coating, electric cables, seal elements, gaskets, etc. are absolutely fit for use in drinking water applications.

1) German Federal Institute for Materials Research

Enclosed pump bearing

- No-maintenance design, high wear resistance.
- For trouble-free long-term operation.

Mixed-flow impellers

- Can be turned down. This means pump performance can be exactly matched to head requirements in the system.

Stainless steel pump shaft

- Fully protected by impeller hubs and sleeves from direct wear caused by the fluid pumped.

The KSB motor

- Efficiencies up to 91 %.
- VDE-compliant, i.e. high level of electrical safety.
- Designed for max. pump power to protect unit from overloads.

Dynamically balanced rotor

- Ensures smooth running.

Reliable pressure balancing system

- Optimum rubber expansion diaphragm design.
- Enables installation at very low depths.

3411:10

UPA 300 - 65 for Well Diameters of 300 mm (12 inches) and above

Pumps with submersible motors for three-phase current (3 ~) / 400 V / d.o.l. (D) or star-delta (Y-Δ) starting

Pump + motor	Pump		Motor				Motor lead ²⁾ , flat	
	Discharge head Q = 0 m ³ /h	Rated power	Max. temperature of the fluid pumped v ≥ 0.2 m/s (= 0 m/s)	Rated current	Efficiency	Power factor	Number x cross-section of conductors (use under water, 400 V and ± 30 °C)	
UPA 300 - 65/ ... + ...	H ₀ m	P _N kW	t _{max} ¹⁾ °C	I _N A	η _M %	cos φ --	D.o.l. mm ²	Y-Δ mm ²
1n + UMA 200D 37/21	30	16.0	44 (42)	43.5	83.0	0.64	3/4 x 6.0 ³⁾	3/4 x 6.0
1m + UMA 200D 37/21	35	20.0	43 (40)	48.5	84.6	0.71	3/4 x 6.0 ³⁾	3/4 x 6.0
1l + UMA 200D 37/21	39	23.0	41 (38)	53.0	85.2	0.75	3/4 x 6.0 ³⁾	3/4 x 6.0
1f + UMA 200D 37/21	42	27.0	38 (34)	59.0	85.5	0.79	3/4 x 6.0 ³⁾	3/4 x 6.0
1 + UMA 200D 37/21	48	34.0	32 (26)	70.0	85.4	0.83	3/4 x 6.0 ³⁾	3/4 x 6.0
2m + UMA 200D 45/21	71	40.0	32 (27)	82.0	86.2	0.82	3/4 x 6.0 ³⁾	3/4 x 6.0
2l + UMA 200D 45/21	77	45.0	28 (21)	90.0	86.0	0.84	3/4 x 6.0 ³⁾	3/4 x 6.0
2g + UMA 200D 55/21	83	54.0	29 (23)	108.0	87.0	0.84	3/4 x 6.0 ³⁾	3/4 x 6.0
2d + UMA 200D 65/21	91	60.0	30 (25)	120.0	87.8	0.83	3/4 x 10.0 ³⁾	3/4 x 10.0
2 + UMA 200D 75/21	98	70.0	27 (20)	143.0	87.4	0.81	3/4 x 10.0 ³⁾	3/4 x 10.0
3k + UMA 200D 75/21	118	72.0	25 (18)	146.0	87.4	0.82	3/4 x 10.0 ³⁾	3/4 x 10.0
3h + UMA 200D 90/21	124	82.0	28 (22)	167.0	88.2	0.81	3/4 x 16.0 ³⁾	3/4 x 16.0
3e + UMA 200D 90/21	130	88.0	26 (18)	177.0	88.1	0.82	3/4 x 16.0 ³⁾	3/4 x 16.0
3d + UMA 250D 110/21	137	95.0	26 (19)	191.0	88.7	0.81	3/4 x 25.0 ³⁾	3/4 x 25.0
3 + UMA 250D 110/21	147	110.0	20 (11)	215.0	88.5	0.84	3/4 x 25.0 ³⁾	3/4 x 25.0
4g + UMA 250D 110/21	167	110.0	19 (10)	215.0	88.5	0.84	3/4 x 25.0 ³⁾	3/4 x 25.0
4e + UMA 250D 132/21	174	120.0	25 (17)	229.0	89.2	0.85	3/4 x 25.0 ³⁾	3/4 x 25.0
4b + UMA 250D 132/21	186	130.0	20 (10)	245.0	89.1	0.86	3/4 x 25.0 ³⁾	3/4 x 25.0
4 + UMA 250D 160/21	196	145.0	21 (12)	276.0	89.4	0.85	3/4 x 25.0 ⁴⁾	3/4 x 35 ⁵⁾
5e + UMA 250D 160/21	217	145.0	20 (11)	276.0	89.4	0.85	3/4 x 25.0 ⁴⁾	3/4 x 35 ⁵⁾
5b + UMA 250D 190/21	235	165.0	22 (13)	325.0	90.0	0.82	3/4 x 35 ⁴⁾ 5)	3/4 x 50 ⁵⁾
5 + UMA 300D 250/22	252	190.0	59 (53)	359.0	90.5	0.85	2x3x70 + 1x35 ⁴⁾ 6)	2x3x70 + 1x35 ⁶⁾
6e + UMA 250D 190/21	261	180.0	19 (9)	349.0	89.8	0.83	3/4 x 35 ⁴⁾ 5)	3/4 x 50 ⁵⁾
6b + UMA 300D 250/22	287	205.0	57 (51)	382.0	90.6	0.86	2x3x70 + 1x35 ⁴⁾ 6)	2x3x70 + 1x35 ⁶⁾
6 + UMA 300D 250/22	300	225.0	55 (49)	414.0	90.7	0.87	2x3x70 + 1x35 ⁴⁾ 6)	2x3x70 + 1x35 ⁶⁾
7 + UMA 300D 300/22	351	265.0	56 (49)	491.0	91.2	0.86	6x1x95 + 1x95 ⁴⁾ 7)	6x1x95 + 1x95 ⁷⁾
8 + UMA 300D 300/22	399	300.0	53 (46)	546.0	91.2	0.87	6x1x95 + 1x95 ⁴⁾ 7)	6x1x95 + 1x95 ⁷⁾

1) also see pages 3 and 79.

2) 3/4 = 1 x 3-core and 1 x 4-core, 90° spacing.

3) Δ wiring in the cable connector or control cabinet.

4) Parallel cable

5) 1 x 3-core, flat and 1 x 4-core, round.

6) 2 x 3-core, flat and 1 x 1-core, round

7) 7 x 1-core, round

Dimensions / Weights / Horizontal Installation ¹⁾

UPA 300 - 65/ ..	L _p ≈ mm	L _A ≈ mm	D _{max} ≈ mm		m _A ≈ kg		Installation ²⁾	A ≈ mm
			D.o.l	Y-Δ	G (Standard)	B (Special)		
1n, 1m, 1l	735	1875	276	276	203	217	v + h	945
1f, 1	735	1875	276	276	203	217	v + h	945
2m, 2l	900	2130	276	276	261	279	v + h	1155
2g	900	2240	276	276	281	299	v + h	1210
2d	900	2370	275	275	304	322	v + h	1275
2	900	2460	275	275	320	338	v + h	1320
3k	1065	2625	275	275	352	374	v + h	1485
3h, 3e	1065	2805	278	278	384	406	v ³⁾	-
3d, 3	1095	2625	289	289	462	484	v + h	1500
4g	1260	2790	289	289	494	520	v + h	1665
4e, 4b	1260	2920	289	289	538	564	v + h	1730
4	1260	3030	289	289	575	601	v ⁴⁾	-
5e	1425	3195	289	289	607	637	v ⁴⁾	-
5b	1425	3345	298	311	658	688	v ³⁾ 4)	-
5	1425	3500	325	325	811	842	v ⁴⁾	-
6e	1590	3510	298	311	690	724	v ³⁾ 4)	-
6b, 6	1590	3665	325	325	843	878	v ⁴⁾	-
7	1755	4010	304	304	953	992	v ⁴⁾	-
8	1920	4175	304	304	985	985	v ⁴⁾	-

1) Including check valve with threaded end and standard motor leads.

2) v = vertical / h = horizontal.

3) Horizontal installation on request.

4) Horizontal installation only with bearing pedestals of special design.

UPA 300 - 65 / ..

The characteristic curves shown are for preliminary selection only. Exact selection data will be provided in our quotation.

Selection

The pressure losses H_v in the check valve are not considered in the pump characteristic curves. For more details and a selection example refer to page 8.

Legend ...

H_v : Head losses in the check valve

η_p : Pump efficiency (not considering check valve)

NPSH: Net positive suction head required by the pump

Pump End G 6" / DN 150

The information is based on the model "with check valve and threaded end".

The changes in the main dimensions of the "flanged end" model or the model "with connection branch" are specified in the table below.

a) Check valve with:

Threaded end G 6"		Flanged end DN 150	
Length mm	Length mm	Outside dia. mm	
255	220 (PN 10/16) 228 (PN 25/40)	285	300

b) Connection branch with:

Threaded end G 6"		Flanged end DN 150	
Length mm	Length mm	Outside dia. mm	
150	140 (PN 10/16) 148 (PN 25/40)	285	300

Threaded end to DIN ISO 228, Part 1.

Flange mating dimensions to DIN 2501, Part 1

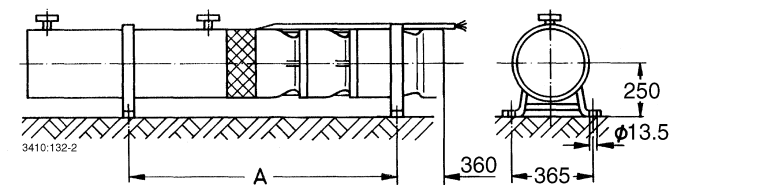
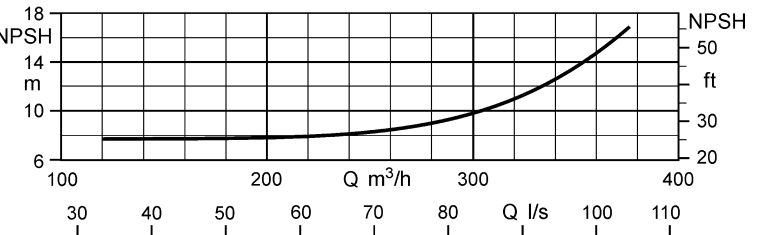
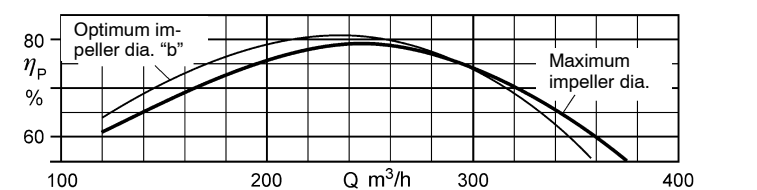
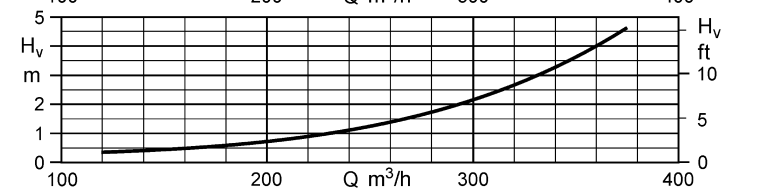
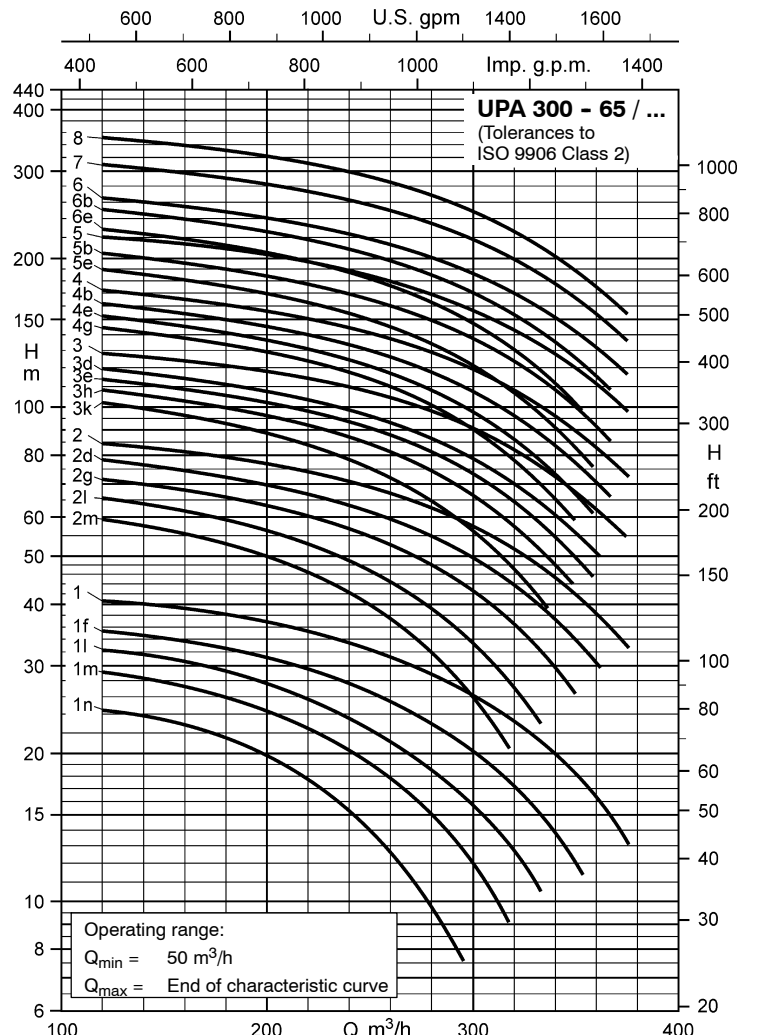
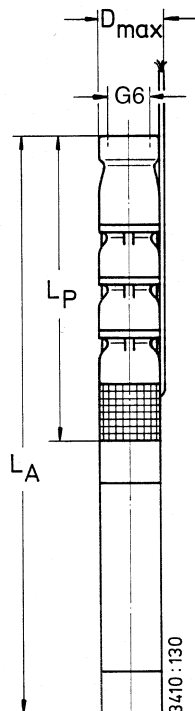

UPA 300 - 94 for Well Diameters of 300 mm (12 inches) and above

Pumps with submersible motors for **three-phase current (3 ~) / 400 V and d.o.l. (D) or star-delta (Y-Δ) starting**

Pump + motor	Pump		Motor				Motor lead ²⁾ , flat	
	Discharge head Q = 0 m ³ /h	Rated power	Max. temperature of the fluid pumped v ≥ 0.2 m/s (= 0 m/s)	Rated current	Efficiency	Power factor	Number x cross-section of conductors (use under water, 400 V and ≤ +30 °C)	
UPA 300 - 94/ ... + ...	H ₀ m	P _N kW	t _{max} ¹⁾ °C	I _N A	η _M %	cos φ --	D.o.l. mm ²	Y-Δ mm ²
1n + UMA 200D 37/21	34	29.0	37 (32)	62	85.6	0.80	3/4 x 6.0 ³⁾	3/4 x 6.0
1m + UMA 200D 37/21	38	32.0	34 (29)	67	85.5	0.82	3/4 x 6.0 ³⁾	3/4 x 6.0
1k + UMA 200D 37/21	43	36.0	30 (25)	73	85.3	0.84	3/4 x 6.0 ³⁾	3/4 x 6.0
1g + UMA 200D 45/21	47	42.0	31 (25)	85	86.1	0.83	3/4 x 6.0 ³⁾	3/4 x 6.0
1d + UMA 200D 45/21	51	45.0	27 (20)	90	86.0	0.84	3/4 x 6.0 ³⁾	3/4 x 6.0
1 + UMA 200D 55/21	54	54.0	29 (23)	108	87.0	0.84	3/4 x 6.0 ³⁾	3/4 x 6.0
2m + UMA 200D 65/21	78	62.0	29 (23)	123	87.7	0.83	3/4 x 10.0 ³⁾	3/4 x 10.0
2k + UMA 200D 75/21	90	74.0	25 (18)	149	87.3	0.83	3/4 x 10.0 ³⁾	3/4 x 10.0
2h + UMA 200D 90/21	96	82.0	28 (22)	167	88.2	0.81	3/4 x 16.0 ³⁾	3/4 x 16.0
2d + UMA 250D 110/21	105	95.0	26 (19)	191	88.7	0.81	3/4 x 25.0 ³⁾	3/4 x 25.0
2 + UMA 250D 110/21	112	110.0	20 (10)	215	88.5	0.84	3/4 x 25.0 ³⁾	3/4 x 25.0
3k + UMA 250D 110/21	138	110.0	20 (10)	215	88.5	0.84	3/4 x 25.0 ³⁾	3/4 x 25.0
3h + UMA 250D 132/21	146	125.0	24 (15)	237	89.1	0.86	3/4 x 25.0 ³⁾	3/4 x 25.0
3e + UMA 250D 132/21	155	130.0	20 (11)	245	89.1	0.86	3/4 x 25.0 ³⁾	3/4 x 25.0
3c + UMA 250D 160/21	162	145.0	20 (11)	276	89.4	0.85	3/4 x 25.0 ⁴⁾	3/4 x 35 ⁵⁾
3 + UMA 250D 190/21	172	165.0	22 (14)	325	90.0	0.82	3/4 x 35 ⁴⁾ 5)	3/4 x 50 ⁵⁾
4f + UMA 250D 190/21	204	175.0	19 (10)	341	89.9	0.83	3/4 x 35 ⁴⁾ 5)	3/4 x 50 ⁵⁾
4c + UMA 300D 250/22	222	205.0	57 (52)	382	90.6	0.86	2x3x70 + 1x35 ⁴⁾ 6)	2x3x70 + 1x35 ⁶⁾
4 + UMA 300D 250/22	232	225.0	55 (49)	414	90.7	0.87	2x3x70 + 1x35 ⁴⁾ 6)	2x3x70 + 1x35 ⁶⁾
5 + UMA 300D 300/22	290	280.0	54 (48)	516	91.2	0.86	6x1x95 + 1x95 ⁴⁾ 7)	6x1x95 + 1x95 ⁷⁾
6 + UMA 300D 400/22	348	335.0	52 (45)	619	91.4	0.86	6x1x95 + 1x95 ⁴⁾ 7)	6x1x95 + 1x95 ⁷⁾
7e + UMA 300D 400/22	371	315.0	54 (47)	586	91.4	0.85	6x1x95 + 1x95 ⁴⁾ 7)	6x1x95 + 1x95 ⁷⁾

1) also see pages 3 and 79.

2) 3/4 = 1 x 3-core and 1 x 4-core, 90° spacing.

3) Δ wiring in the cable connector or control cabinet.

4) Parallel cable

5) 1 x 3-core, flat and 1 x 4-core, round.

6) 2 x 3-core, flat and 1 x 1-core, round

7) 7 x 1-core, round

Dimensions / Weights / Horizontal Installation ¹⁾

UPA 300 - 94/ ..	L _p ≈ mm	L _A ≈ mm	D _{max} ≈ mm		m _A ≈ kg		Installation ²⁾	A ≈ mm
			D.o.l	Y-Δ	G (Standard)	B (Special)		
1n	775	1915	286	286	227	245	v + h	960
1m	775	1915	286	286	227	245	v + h	960
1k	775	1915	286	286	227	245	v + h	960
1g	775	2005	286	286	253	271	v + h	1005
1d	775	2005	286	286	253	271	v + h	1005
1	775	2115	286	286	273	291	v + h	1060
2m	950	2420	285	285	329	352	v + h	1300
2k	950	2510	285	285	345	368	v + h	1345
2h	950	2690	288	288	377	400	v ³⁾	-
2d	980	2510	299	299	450	473	v + h	1360
2	980	2510	299	299	450	473	v + h	1360
3k	1155	2685	299	299	483	511	v + h	1535
3h	1155	2815	299	299	527	555	v + h	1600
3e	1155	2815	299	299	527	555	v + h	1600
3c	1155	2925	299	308	564	592	v + h	1655
3	1155	3075	308	321	615	643	v ³⁾ 4)	-
4f	1330	3250	308	321	648	681	v ³⁾ 4)	-
4c	1330	3405	331	331	797	831	v ⁴⁾	-
4	1330	3405	331	331	797	831	v ⁴⁾	-
5	1505	3760	311	311	908	947	v ⁴⁾	-
6	1680	4055	311	311	993	1037	v ³⁾ 4)	-
7e	1855	4230	311	311	1026	1075	v ³⁾ 4)	-

1) Including check valve with threaded end and standard motor leads.

2) v = vertical / h = horizontal.

3) Horizontal installation on request.

4) Horizontal installation only with bearing pedestals of special design.

UPA 300 - 94 / ..

The characteristic curves shown are for preliminary selection only. Exact selection data will be provided in our quotation.

Selection

The pressure losses H_v in the check valve are not considered in the pump characteristic curves. For more details and a selection example refer to page 8.

Legend ...

- H_v : Head losses in the check valve
- η_p : Pump efficiency (not considering check valve)
- NPSH: Net positive suction head required by the pump

Pump End G 8" / DN 200

The information is based on the model "with check valve and threaded end". The changes in the main dimensions of the "flanged end" model or the model "with connection branch" are specified in the table below.

a) Check valve with:

Threaded end G 8"		Flanged end DN 200	
Length mm	Length mm	Outside dia. mm	
290	240 (PN 10)	340	
	240 (PN 16)	340	
	244 (PN 25)	360	

b) Connection branch with:

Threaded end G 8"		Flanged end DN 200	
Length mm	Length mm	Outside dia. mm	
200	134 (PN 10)	340	
	134 (PN 16)	340	
	138 (PN 25)	360	

Threaded end to DIN ISO 228, Part 1.

Flange mating dimensions to DIN 2501, Part 1

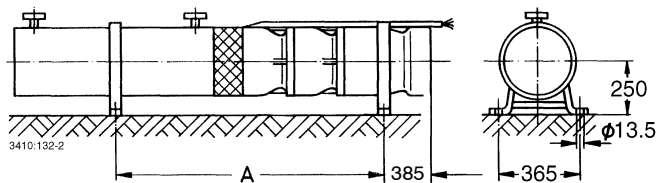
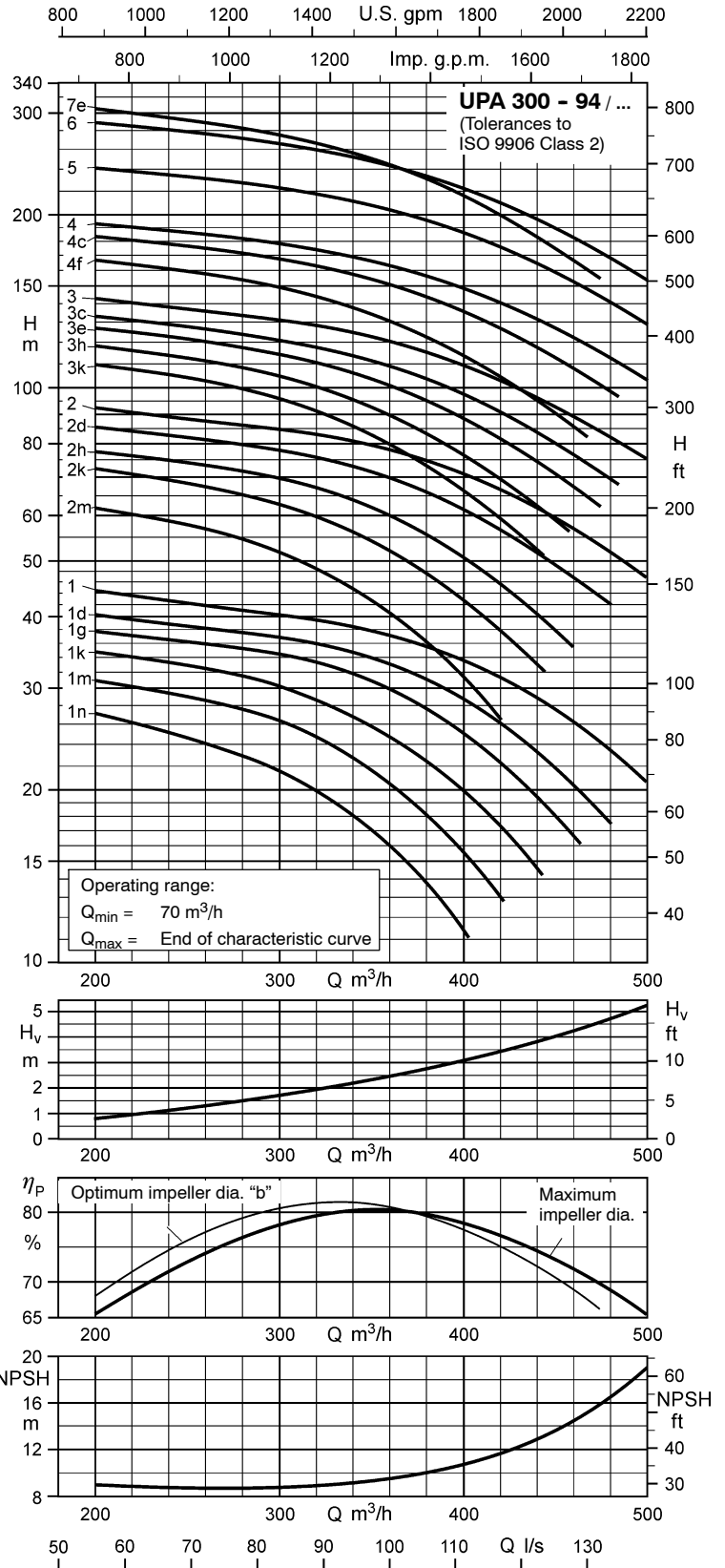
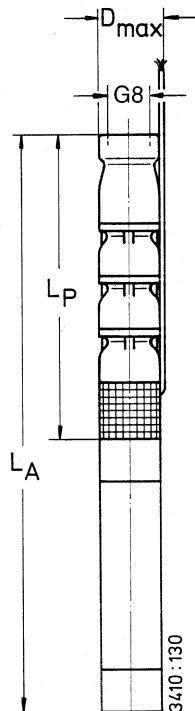

UPA 350 - 128 for Well Diameters of 350 mm (14 inches) and above

 Pumps with submersible motors for **three-phase current (3~) / 400 V** and **d.o.l. (D)** or **star-delta (Y-Δ)** starting

Pump + motor	Pump	Motor					Motor lead ²⁾ , flat	
	Discharge head Q = 0 m ³ /h H _o m	Rated power P _N kW	Max. temperature of the fluid pumped v ≥ 0.2 m/s (= 0 m/s) t _{max} ¹⁾ °C	Rated current I _N A	Efficiency η _M %	Power factor cos φ --	Number x cross-section of conductors (use under water, 400 V and ≤ +30 °C) D.o.l. mm ² Y-Δ mm ²	
UPA 350 - 128/ ... + ...								
1l + UMA 200D 37/21	40	35.0	31 (25)	72	85.3	0.83	3/4 x 6.0 ³⁾	3/4 x 6.0
1k + UMA 200D 45/21	45	44.0	28 (22)	89	86.0	0.84	3/4 x 6.0 ³⁾	3/4 x 6.0
1h + UMA 200D 55/21	52	55.0	27 (20)	109	86.9	0.84	3/4 x 6.0 ³⁾	3/4 x 6.0
1f + UMA 200D 65/21	57	64.0	28 (22)	127	87.7	0.84	3/4 x 10.0 ³⁾	3/4 x 10.0
1d + UMA 200D 75/21	63	75.0	23 (15)	151	87.3	0.83	3/4 x 10.0 ³⁾	3/4 x 10.0
1b + UMA 200D 90/21	69	88.0	25 (18)	177	88.1	0.82	3/4 x 16.0 ³⁾	3/4 x 16.0
1 + UMA 250D 110/21	75	105.0	22 (14)	208	88.6	0.83	3/4 x 25.0 ³⁾	3/4 x 25.0
2h + UMA 250D 110/21	104	110.0	19 (10)	215	88.5	0.84	3/4 x 25.0 ³⁾	3/4 x 25.0
2g + UMA 250D 132/21	109	120.0	24 (16)	229	89.2	0.85	3/4 x 25.0 ³⁾	3/4 x 25.0
2e + UMA 250D 132/21	117	132.0	18 (9)	249	89.0	0.86	3/4 x 25.0 ³⁾	3/4 x 25.0
2d + UMA 250D 160/21	126	150.0	18 (9)	284	89.3	0.86	3/4 x 25.0 ⁴⁾	3/4 x 35 ⁵⁾
2b + UMA 250D 190/21	138	175.0	19 (10)	341	89.9	0.83	3/4 x 35 ⁴⁾ ⁵⁾	3/4 x 50 ⁵⁾
2 + UMA 300D 250/22	153	210.0	57 (51)	389	90.7	0.86	2x3x70 + 1x35 ⁴⁾ ⁶⁾	2x3x70 + 1x35 ⁶⁾
3c + UMA 300D 250/22	196	240.0	54 (47)	439	90.7	0.87	2x3x70 + 1x35 ⁴⁾ ⁶⁾	2x3x70 + 1x35 ⁶⁾
3 + UMA 300D 300/22	228	300.0	52 (45)	546	91.2	0.87	6x1x95 + 1x95 ⁴⁾ ⁷⁾	6x1x95 + 1x95 ⁷⁾
4b + UMA 300D 400/22	280	355.0	50 (42)	652	91.4	0.86	6x1x95 + 1x95 ⁴⁾ ⁷⁾	6x1x95 + 1x95 ⁷⁾
4 + UMA 300D 400/22	302	400.0	45 (35)	728	91.2	0.87	6x1x95 + 1x95 ⁴⁾ ⁷⁾	6x1x95 + 1x95 ⁷⁾

1) also see pages 3 and 79.

2) 3/4 = 1 x 3-core and 1 x 4-core, 90° spacing.

3) Δ wiring in the cable connector or control cabinet.

4) Parallel cable

5) 1 x 3-core, flat and 1 x 4-core, round.

6) 2 x 3-core, flat and 1 x 1-core, round

7) 7 x 1-core, round

Dimensions / Weights / Horizontal Installation ¹⁾

UPA 350 - 128/ ..	L _p ≈ mm	L _A ≈ mm	D _{max} ≈ mm		m _A ≈ kg		Installation ²⁾	A ≈ mm
			D.o.l.	Y-Δ	G (Standard)	B (Special)		
1l	898	2040	322	322	243	265	v + h	1020
1k	898	2130	322	322	269	291	v + h	1065
1h	898	2240	322	322	289	311	v + h	1120
1f	898	2370	320	320	312	334	v + h	1185
1d	898	2460	320	320	328	350	v + h	1230
1b	898	2640	324	324	360	382	v ³⁾	-
1	898	2425	334	334	432	454	v + h	1215
2h	1098	2625	334	334	474	502	v + h	1415
2g	1098	2755	334	334	518	546	v + h	1480
2e	1098	2755	334	334	518	546	v + h	1480
2d	1098	2865	334	343	555	583	v + h	1535
2b	1098	3015	343	357	606	634	v ³⁾ ⁴⁾	-
2	1108	3180	360	360	764	793	v ⁴⁾	-
3c	1308	3380	360	360	806	840	v ⁴⁾	-
3	1308	3560	341	341	884	918	v ⁴⁾	-
4b	1508	3880	341	341	978	1018	v ³⁾ ⁴⁾	-
4	1508	3880	341	341	978	1018	v ³⁾ ⁴⁾	-

1) Including check valve with threaded end and standard motor leads.

2) v = vertical / h = horizontal.

3) Horizontal installation on request.

4) Horizontal installation only with bearing pedestals of special design.

UPA 350 - 128 / ..

The characteristic curves shown are for preliminary selection only. Exact selection data will be provided in our quotation.

Selection

The pressure losses H_v in the check valve are not considered in the pump characteristic curves. For more details and a selection example refer to page 8.

Legend ...

- H_v : Head losses in the check valve
- η_p : Pump efficiency (not considering check valve)
- NPSH: Net positive suction head required by the pump

Pump End G 8" / DN 200 1)

The information is based on the model "with check valve and threaded end". The changes in the main dimensions of the "flanged end" model or the model "with connection branch" are specified in the table below.

a) Check valve with:

Threaded end G 8"		Flanged end DN 200	
Length mm	Length mm	Outside dia. mm	
328	278 (PN 10) 278 (PN 16)	340	

b) Connection branch with:

Threaded end G 8"		Flanged end DN 200	
Length mm	Length mm	Outside dia. mm	
169	123 (PN 10) 123 (PN 16)	340	

Threaded end to DIN ISO 228, Part 1

Flange mating dimensions to DIN 2501, Part 1

1) DN 250 check valve (with flanged end only) on request. For relevant head losses see H_v curve plotted over Q.

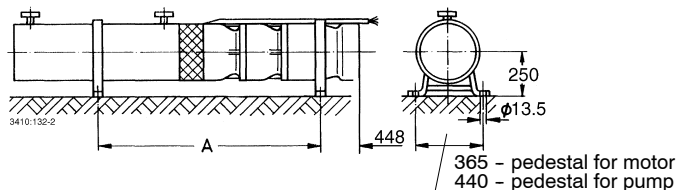
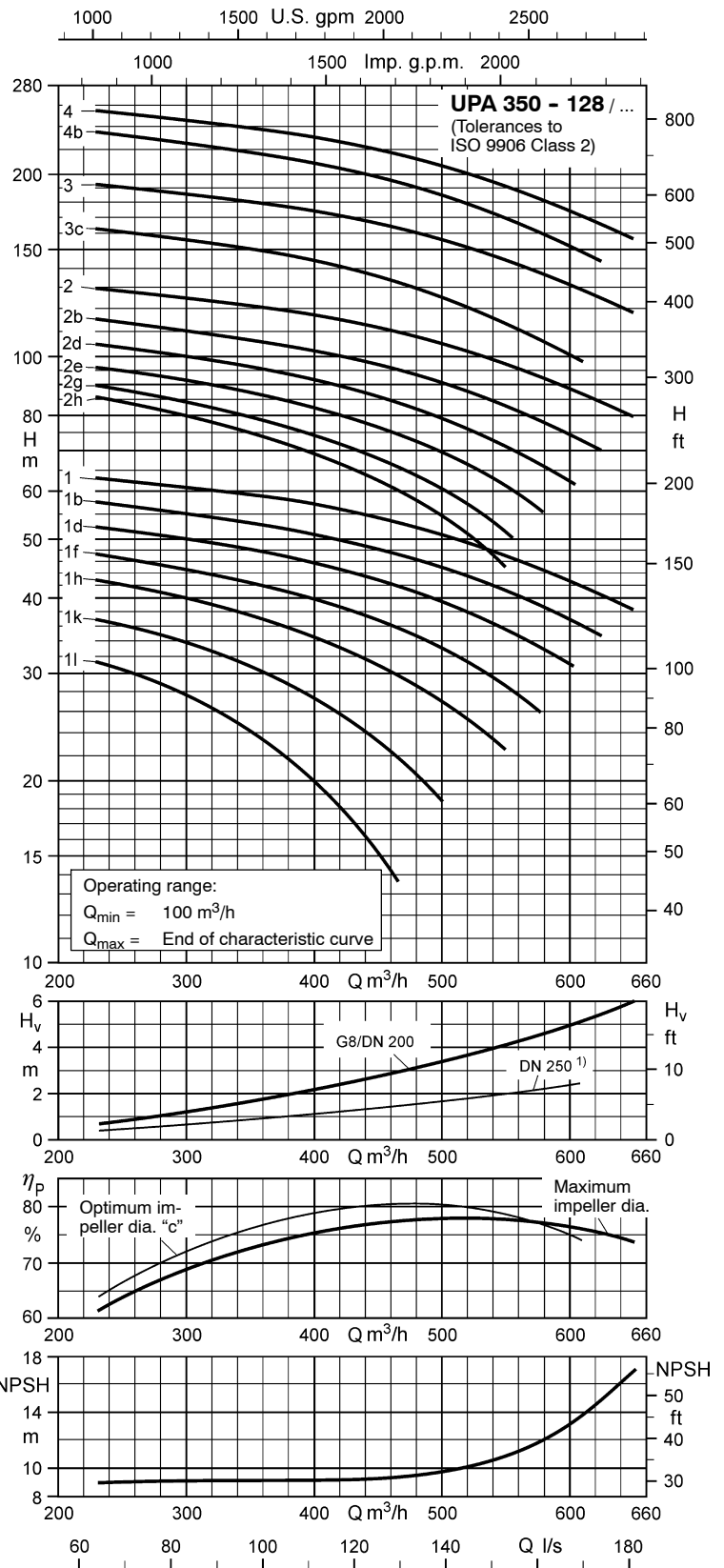
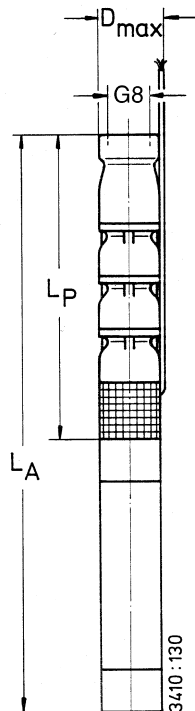

UPA 350 - 180 for Well Diameters of 350 mm (14 inches) and above

 Pumps with submersible motors for **three-phase current (3~) / 400 V** and **d.o.l. (D)** or **star-delta (Y-Δ)** starting

Pump + motor	Pump	Motor					Motor lead ²⁾ , flat	
	Discharge head Q = 0 m ³ /h	Rated power	Max. temperature of the fluid pumped v ≥ 0.2 m/s (= 0 m/s)	Rated current	Efficiency	Power factor	Number x cross-section of conductors (use under water, 400 V and ≤ +30°C)	
UPA 350 - 180/ ... + ...	H ₀ m	P _N kW	t _{max} ¹⁾ °C	I _N A	η _M %	cos φ --	D.o.l. mm ²	Y-Δ mm ²
1m + UMA 200D 55/21	41	54.0	29 (23)	108	87.0	0.84	3/4 x 6.0 ³⁾	3/4 x 6.0
1l + UMA 200D 65/21	45	62.0	30 (24)	123	87.7	0.83	3/4 x 10.0 ³⁾	3/4 x 10.0
1h + UMA 200D 65/21	49	65.0	28 (21)	129	87.7	0.84	3/4 x 10.0 ³⁾	3/4 x 10.0
1e + UMA 200D 75/21	55	75.0	24 (16)	151	87.3	0.83	3/4 x 10.0 ³⁾	3/4 x 10.0
1c + UMA 200D 90/21	62	86.0	27 (20)	173	88.1	0.82	3/4 x 16.0 ³⁾	3/4 x 16.0
1 + UMA 250D 110/21	66	100.0	25 (17)	199	88.6	0.82	3/4 x 25.0 ³⁾	3/4 x 25.0
2k + UMA 250D 132/21	95	130.0	22 (13)	245	89.1	0.86	3/4 x 25.0 ³⁾	3/4 x 25.0
2g + UMA 250D 132/21	100	132.0	18 (9)	249	89.0	0.86	3/4 x 25.0 ³⁾	3/4 x 25.0
2f + UMA 250D 160/21	111	150.0	20 (11)	284	89.3	0.86	3/4 x 25.0 ⁴⁾	3/4 x 35 ⁵⁾
2d + UMA 250D 190/21	121	165.0	22 (14)	325	90.0	0.82	3/4 x 35 ⁴⁾ ⁵⁾	3/4 x 50 ⁵⁾
2b + UMA 250D 190/21	128	180.0	18 (9)	349	89.8	0.83	3/4 x 35 ⁴⁾ ⁵⁾	3/4 x 50 ⁵⁾
2 + UMA 300D 250/22	137	210.0	57 (51)	389	90.7	0.86	2x3x70 + 1x35 ⁴⁾ ⁶⁾	2x3x70 + 1x35 ⁶⁾
3e + UMA 300D 250/22	173	240.0	53 (47)	439	90.7	0.87	2x3x70 + 1x35 ⁴⁾ ⁶⁾	2x3x70 + 1x35 ⁶⁾
3 + UMA 300D 400/22	205	320.0	54 (47)	595	91.4	0.85	6x1x95 + 1x95 ⁴⁾ ⁷⁾	6x1x95 + 1x95 ⁷⁾
4f + UMA 300D 400/22	226	310.0	54 (47)	580	91.4	0.85	6x1x95 + 1x95 ⁴⁾ ⁷⁾	6x1x95 + 1x95 ⁷⁾
4d + UMA 300D 400/22	245	345.0	51 (44)	634	91.4	0.86	6x1x95 + 1x95 ⁴⁾ ⁷⁾	6x1x95 + 1x95 ⁷⁾

¹⁾ also see pages 3 and 79.

²⁾ 3/4 = 1 x 3-core and 1 x 4-core, 90° spacing

³⁾ Δ-wiring in the cable connector or control cabinet.

⁴⁾ Parallel

⁵⁾ 1 x 3-core, flat and 1 x 4-core, round.

⁶⁾ 2 x 3-core, flat and 1 x 1-core, round

⁷⁾ 7 x 1-core, round

Dimensions / Weights / Horizontal Installation ¹⁾

UPA 350 - 180/ ..	L _p ≈ mm	L _A ≈ mm	D _{max} ≈ mm		m _A = kg		Installation ²⁾	A ≈ mm
			D.o.l.	Y-Δ	G (Standard)	B (Special)		
1m	898	2240	322	322	289	311	v + h	1120
1l	898	2370	320	320	312	334	v + h	1185
1h	898	2370	320	320	312	334	v + h	1185
1e	898	2460	320	320	328	350	v + h	1230
1c	898	2640	324	324	360	382	v ³⁾	-
1	898	2425	334	334	432	454	v + h	1215
2k	1098	2755	334	334	518	546	v + h	1480
2g	1098	2755	334	334	518	546	v + h	1480
2f	1098	2865	334	343	555	583	v + h	1535
2d	1098	3015	343	357	606	634	v ³⁾ ⁴⁾	-
2b	1098	3015	343	357	606	634	v ³⁾ ⁴⁾	-
2	1108	3180	360	360	764	793	v ⁴⁾	-
3e	1308	3380	360	360	806	840	v ⁴⁾	-
3	1308	3680	341	341	936	970	v ³⁾ ⁴⁾	-
4f	1508	3880	341	341	978	1018	v ³⁾ ⁴⁾	-
4d	1508	3880	341	341	978	1018	v ³⁾ ⁴⁾	-

¹⁾ Including check valve with threaded end and standard motor leads.

²⁾ v = vertical / h = horizontal.

³⁾ Horizontal installation on request.

⁴⁾ Horizontal installation only with bearing pedestals of special design.

UPA 350 - 180 /..

The characteristic curves shown are for preliminary selection only. Exact selection data will be provided in our quotation.

Larger discharge heads (units with UMA 300D motors) on request.

Selection

The pressure losses H_v in the check valve are not considered in the pump characteristic curves. For more details and a selection example refer to page 8.

Legend ...

- H_v : Head losses in the check valve
- η_p : Pump efficiency (not considering check valve)
- NPSH: Net positive suction head required by the pump

Pump End G 8" / DN 200 1)

The information is based on the model "with check valve and threaded end".

The changes in the main dimensions of the "flanged end" model or the model "with connection branch" are specified in the table below.

a) Check valve with:

Threaded end G 8"		Flanged end DN 200	
Length mm		Length mm	Outside dia. mm
328		278 (PN 10) 278 (PN 16)	340

b) Connection branch with:

Threaded end G 8"		Flanged end DN 200	
Length mm		Length mm	Outside dia. mm
169		123 (PN 10) 123 (PN 16)	340

Threaded end to DIN ISO 228, Part 1.

Flange mating dimensions to DIN 2501, Part 1

1) DN 250 check valve (with flanged end only) on request. For relevant head losses see H_v curve plotted over Q.

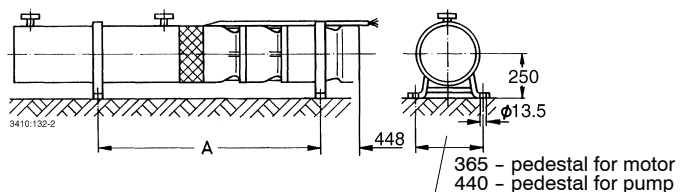
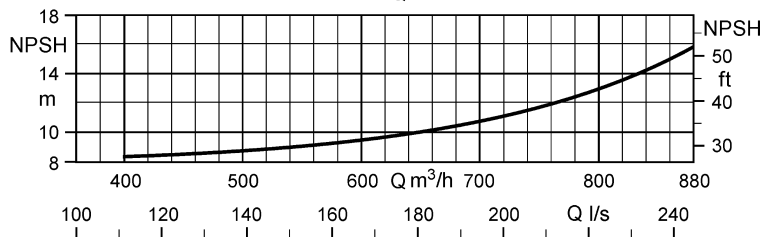
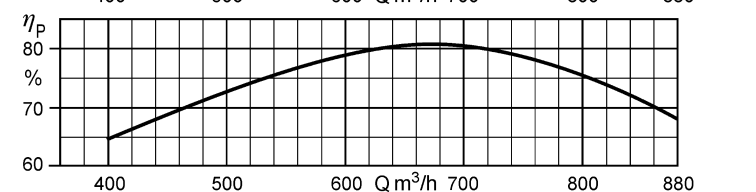
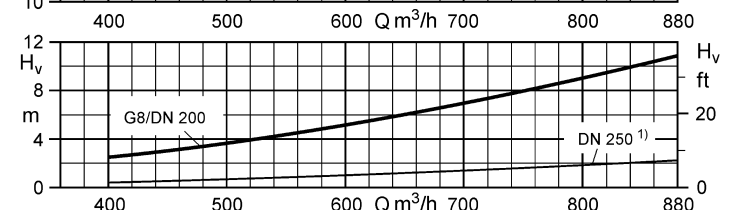
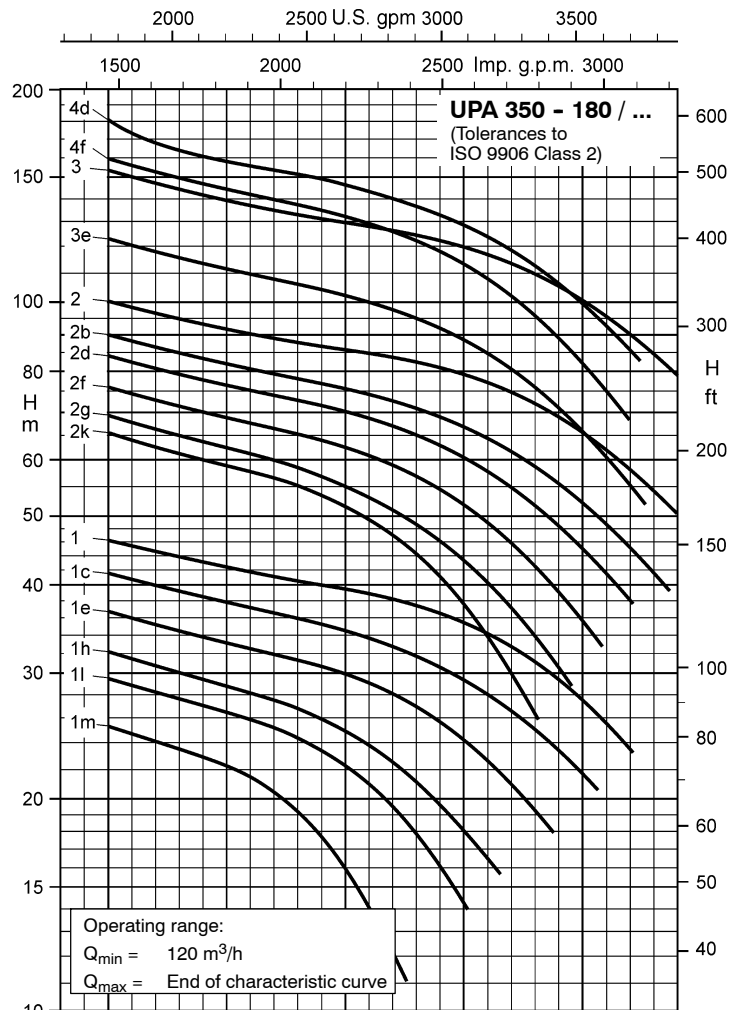
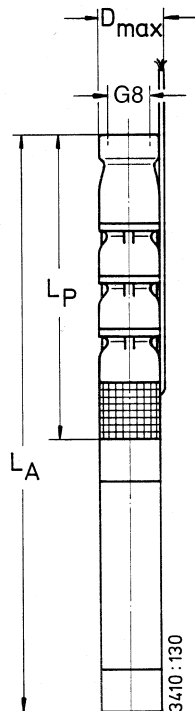

Applications

Handling clean and raw water in applications such as:

- general water extraction / supply,
- irrigation and spray irrigation,
- lowering and maintaining ground water levels in open-cast mines,
- dewatering and gallery drainage in underground mines.

Use in pressure-boosting as well as for offshore and cavern applications, etc.

Permissible sand content in the fluid handled: 50 g/m³.

Operating Data

Capacity	Q up to 2200 m ³ /h (610 l/s)
Head	H up to 240 m
Temperature of fluid handled	t up to + 50 °C
Speed	n ≈ 1450 rpm

Design

Single- or multi-stage, single-entry centrifugal pumps in ring-section design. For vertical and horizontal installation. Mixed flow hydraulic systems, also available with reduced impeller diameters. Stage casings connected by means of studs.

Suction casing between pump and motor equipped with strainer to protect the pump from coarse particles in the fluid.

Pumps with check valve or connection branch on option. Both models with flanged end.

Particularly suitable for installation in narrow deep wells.

Designation (Example)

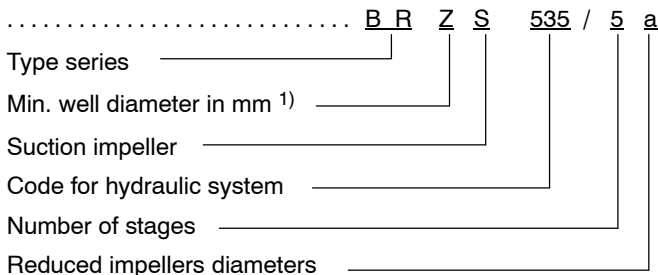

¹⁾ X = 400 mm (16 inches), Y = 450 mm (18 inches),
 Z = 500 mm (20 inches), E = 600 mm (24 inches),
 F = 650 mm (26 inches)

Certification

Quality management certified to ISO 9001

Submersible Borehole Pumps for Well Diameters of 400 mm (16 inches) and above



Product Features

- Very sturdy design
- Suitable for installation in narrow deep wells
- High efficiency
- Motor designed for maximum pump output
- Low noise level
- For vertical or horizontal installation
- Check valve protected against blocking
- Pre-filled motor; no risk of contamination of the handled water

Selection Chart (Ranges on Offer)

$n \approx 1450$ rpm

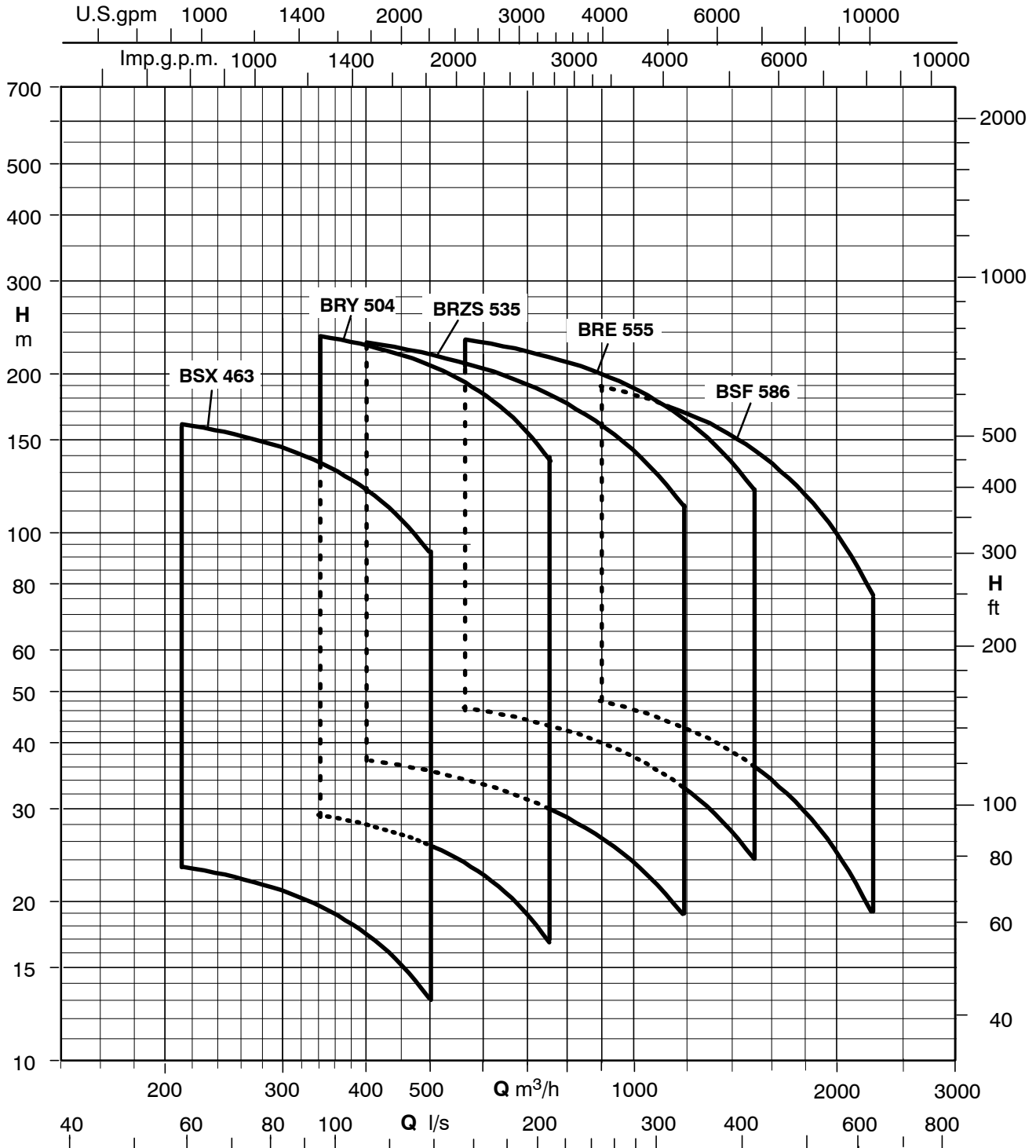

3430:80

Note: The diagram shows the ΔQA range on offer. The pumps can be offered for any duty point within this flow range.

Materials

	G	B
Pump ...		
Casing	Cast iron JL1030 (GG-20)	Bronze (G-CuSn10)
Impeller	Bronze (G-CuSn10)	
Shaft	Cr steel (1.4021)	CrNiMo steel (1.4462)
Wear rings	Bronze (2.1090)	
Bearings	Cr steel (1.4021) annealed / special bronze	Alu bronze (G-CuAl11Ni) / special bronze
Motor ...		
Shaft	CrNiMo steel (1.4462)	
Cast parts	Cast iron JL1040 (GG-20)	Bronze (G-CuSn10)
Stator case	CrNiMo steel (1.4462)	

Bearings / Lubrication

Radial plain bearings: pump bearings lubricated by the fluid handled, motor bearings by the motor's water fill. Depending on the pump size and number of stages, 1 or 2 intermediate bearings are fitted in the pump.

Axial thrust is balanced by a tilting-pad thrust bearing in the motor (lower end).

Direction of Rotation of the Pump

Clockwise rotation (when looking at the drive shaft end).

Pump End (Discharge Nozzle)

Flange DN 200 up to DN 400 depending on pump size.

Coating (Standard)

Quality 2-component high-build coating (epoxy resin base), approved for drinking water contact.
 Coating structure Primer and top coat.
 Film thickness 100 to 150 µm.
 Colour ultramarine blue (RAL 5002).

Type of Installation

In general, the pumps are installed vertically. Some models may also be installed horizontally depending on the number of stages and motor size.

Drive

Type water-filled submersible squirrel-cage motor, 4 poles
 Type of enclosure IP 68
 Frequency 50 Hz
 Type of current three-phase (3~)
 Rated voltage U up to 6000 V
 Rated power P_N up to 2000 kW
 Frequency of starts 5 / h
 Minimum delay before re-starting 3 min
 Motor design is in compliance with VDE regulations.

Connection to Power Supply

The submersible motors are supplied ex factory with 1 or 2 motor leads, each equipped with an earth conductor. All motors are provided with internal earthing. Any extension cables required are connected using water-tight cable connectors. On request, the entire length of cable required can be connected to the motor at the factory.

Starting

Low voltage (U ≤ 1000 V): direct on line (without or with autotransformer or soft starter) and star-delta starting.
 High voltage (U > 1000 V): only direct on line.

Application Temperatures

The submersible borehole pumps are, as a standard, suitable for use in water with temperatures of up to t = +30 °C. An indispensable requirement for this is a flow velocity of v ≥ 0.2 m/s past the motor. This requirement is met, for example, when the pump is installed in a deep well above the well screen / filter, etc.

With certain restrictions, some motor sizes may also be used in water with temperatures of up to t = +50 °C or for operation without an adequate cooling flow of water past the motor, i.e. v = 0 m/s (for example, when the unit is installed in a deep well below the screen / filter area or in a pump sump, etc.).

Variants Available

- Other materials
- Higher fluid temperatures
- Higher voltages up to 10,000 V
- Other frequencies
- More wear-resistant designs
- Models with cooling, suction or pressure shroud
- Special coating
- Motor in special design

Design Features

Check valve with antiblockage valve disc

- No jamming or tilting.
- Spring-loaded design makes for minimum valve closing times and prevents waterhammer.

Robust wear rings

- Replaceable wear rings (fitted with casing and impeller wear rings as a standard) made of wear and corrosion-resistant metal.
- Protection against wear in the clearance; easy servicing.

Stainless steel union elements

- All wetted bolts, screws and nuts are made of CrNiMo steel.
- High operating reliability and simplified dismantling.

Counter thrust bearing

- Reliable balancing of negative axial thrust.
- Impellers do not rub on the stage casings.

Tried and tested thrust bearing

- Water-lubricated self-aligning tilting-pad journal bearing.
- No-maintenance design suitable for maximum load-carrying capacity under continuous operation conditions.

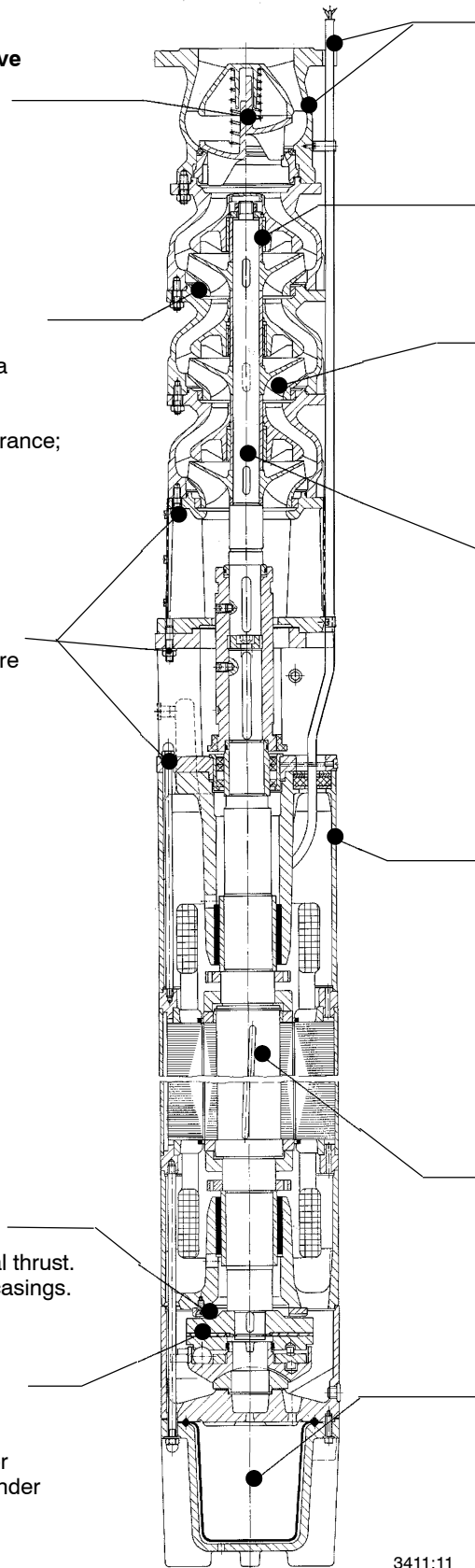

Coating and electric cable suitable for use with drinking water (BAM)¹⁾

- Absolutely fit for use in drinking water applications.

1) German Federal Institute for Materials Research

Enclosed pump bearing

- No-maintenance design, high wear resistance.
- For troublefree long-term operation.

Mixed flow impellers

- Can be turned down. This means pump performance can be exactly matched to head requirements in the system.
- Impellers are fixed with keys for reliable power transmission. This simplifies assembly and dismantling.

Stainless steel pump shaft

- Fully protected by impeller hubs and sleeves from direct wear caused by the fluid pumped.

KSB submersible motor

- VDE-compliant, i.e., high level of electrical safety.
- Designed for max. pump power to protect unit from overloads.

Dynamically balanced rotor

- Ensures smooth running.

Reliable pressure balancing system

- Optimum rubber expansion diaphragm design.
- Enables installation at very low depths.

3411:11

Applications

Handling clean and raw water in applications such as:

- general water extraction / supply,
- irrigation and spray irrigation,
- lowering and maintaining ground water levels in open-cast mines,
- dewatering and gallery drainage in underground mines.

Use in pressure-boosting as well as for offshore and cavern applications, etc.

Permissible sand content in the fluid handled: 50 g/m³.

Operating Data

Capacity	Q	up to 2,200 m ³ /h (612 l/s)
Head	H	up to 1,500 m
Supply voltage	U	up to 6,600 V
Temperature of fluid handled	t	up to +40 °C
Speed	n	2900 rpm and 1450 rpm

Design

Multistage, double-entry ring-section pump with back-to-back impeller arrangement. For vertical installation. Radial and mixed-flow hydraulic systems with impellers that can be turned down.

Half the flow enters the pump through the lower suction casing, the other half through the upper suction casing. The upper half of the pump unit is surrounded by a pressure shroud (outer shell). The two flows are collected by the channel created by the shroud and carried into the upper suction casing, which is equipped with two discharge branches. This configuration is designed to ensure full axial thrust balancing. The casing components (stage casings) are connected by means of round tie bolts. The two suction casings are equipped with strainers to protect the pump from coarse particles in the fluid. Flanged pump end. Check valve with flanged end available on request.

Particularly suitable for installation in narrow deep wells.

Pump Designation (Example)

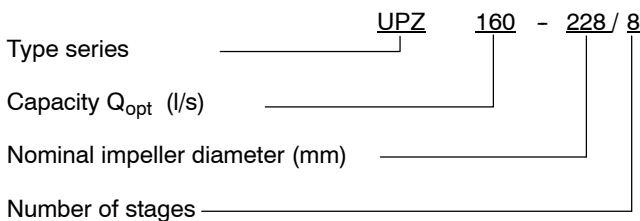

Certification

Quality management certified to ISO 9001

Submersible Borehole Pumps for Well Diameters of 500 mm (20 inches) and above



Selection Chart (Ranges on Offer)

$n \approx 2900$ rpm and $n \approx 1450$ rpm

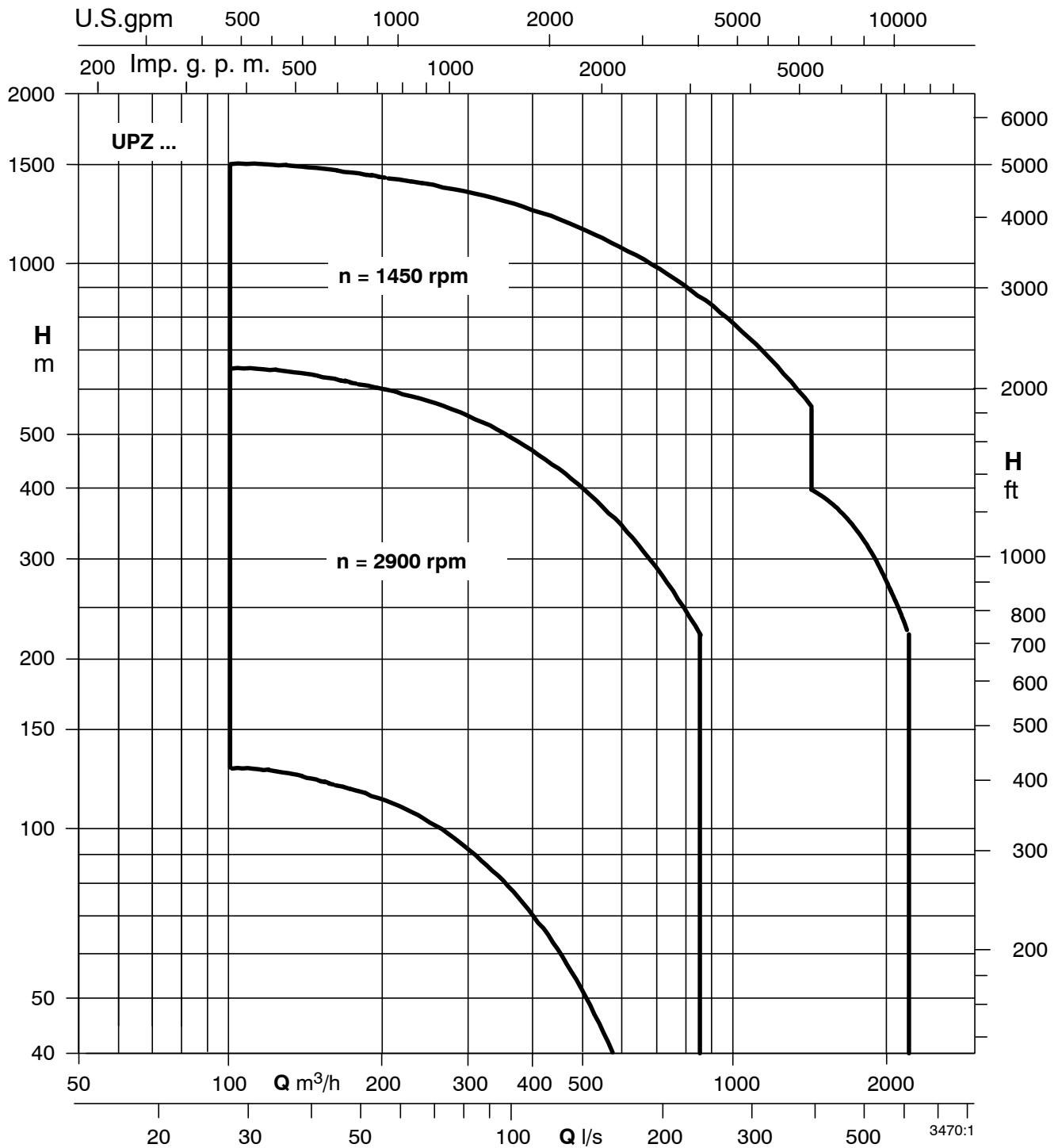

Note: The diagram shows the ΔQ_A range on offer. The pumps can be offered for any duty point within this flow range.

Materials

The choice of materials depends on the flow rate and discharge head.

Component	Material
Pump	
Casing	Cast iron (GJL-200) Nodular cast iron (GJS-600) Bronze (CuSn10) Aluminium bronze (CuAl10Ni) CrNi steel
Impeller/ Diffuser	Bronze (CuSn10) Aluminium bronze (CuAl10Ni) CrNi steel
Shaft	CrNi steel (1.4057) CrNiMo steel (1.4462)
Wear ring	Aluminium bronze (CuAl10Ni) CrNiMo steel
Bearings	Chrome steel (1.4021), hard chrome plated / special bronze or other special materials
Screws, bolts and nuts ¹⁾	CrNiMo steel
Motor	
Shaft	Steel (1.0503+N), protected
Cast parts	Cast iron (GJL-200) Bronze (CuSn10) Aluminium bronze (CuAl10Ni) CrNi steel
Stator case	St 37, CrNiMo steel
Screws, bolts and nuts ¹⁾	CrNiMo steel

¹⁾ in contact with fluid handled

Bearings / Lubrication

Pump:

1 radial plain bearing in each suction casing. Depending on the pump size and number of stages, 1 additional intermediate bearing each in the two pump halves. Lubricated by the fluid pumped.

Motor:

2 radial plain bearings. Residual axial thrust is balanced by 1 self-aligning tilting-pad thrust bearing in the motor (lower end). Lubricated by the motor's water fill.

Direction of Rotation of the Pump

Clockwise rotation (when looking at the drive shaft end).

Pump End (Discharge Nozzle)

With DN 200 to DN 350 flanges to DIN 2526 and 2512, depending on the pump size.

Coating (Standard)

For cast iron models only.

Quality 2-component high-build coating (epoxy resin base), approved for drinking water contact.

Coating structure .. Primer and top coat.

Film thickness 100 to 150 µm.

Colour ultramarine blue (RAL 5002).

Type of Installation

In general, the pumps are installed vertically.

Drive

KSB submersible squirrel-cage motor, 2 or 4 poles. Three-phase current (3~). For supply voltages up to U = 6600 V. Water-filled motor. The water fill lubricates the bearings and cools the windings sealed with water-tight insulation material. Internal cooling circuit. The shaft is sealed by lip seals or a mechanical seal protected from ingress of sand. Pressure differences between motor and environment are equalized by a rubber expansion diaphragm in the motor.

Motor design is in compliance with VDE regulations.

Connection to Power Supply

The motors are supplied ex factory with 1 or 2 motor leads.

Any extension cables required are connected using cable connectors. On request, the entire length of cable required can be connected to the motor at the factory. All motor sizes are available either with or without earth conductor.

Starting

Low voltage (U ≤ 1000 V): d.o.l (without or with autotransformer or soft starter) and star-delta (Y-Δ) starting.

High voltage (U > 1000 V): d.o.l. starting only.

Variants Available

- Other material variants
- Higher fluid temperatures
- More wear-resistant designs
- Models with cooling, suction or pressure shroud
- Special coating
- Special explosion protection up to 6 kV

Design Features

Robust wear rings

- Replaceable wear rings made of wear- and corrosion-resistant metal.
- Protection against wear in the clearance; easy servicing.

Pump shroud

- Slim, low-weight design.
- High operating reliability because of simple sealing of high-pressure section.

Impellers

- Can be turned down.
- This means pump performance can be matched exactly to head requirements in the system.

Stainless steel union elements

- All wetted bolts, screws and nuts are made of CrNiMo steel.
- High operating reliability.

Wear-resistant mechanical seal

- Long service life and high operating reliability.

Motor can be filled with drinking water

- Simply top up whenever needed.

Winding insulation (J2)

- Cu-VPE-PA material makes for maximum heat resistance.

Tried and tested thrust bearing

- New materials combination (stainless steel / carbon) for high safety factor.

Sealing elements

- All joints sealed by O-rings. Pressure-proof up to a differential pressure of 16 bar.

Enclosed pump bearing

- No-maintenance design, high wear resistance.
- For trouble-free long-term operation.

Stainless steel pump shaft

- Fully protected by impeller hubs and sleeves from direct wear caused by the fluid pumped.

Double-entry design with impellers in back-to-back arrangement

- Low wear thanks to low velocities in the pump and use of special materials.
- Designed to ensure full hydraulic thrust balancing, irrespective of any wear in the sealing clearances.
- Considerably reduced load on the thrust bearing.
- This allows high discharge heads at relatively large flow rates.

Circulation cooling through double shroud

- Low temperature rise

High efficiency η_M

- Reduced operating costs thanks to optimized windings.

Optimized cooling pump

- No peak temperatures.

Reliable pressure balancing system

- Optimum selection thanks to generously sized rubber diaphragm.
- Enables installation at very low depths.

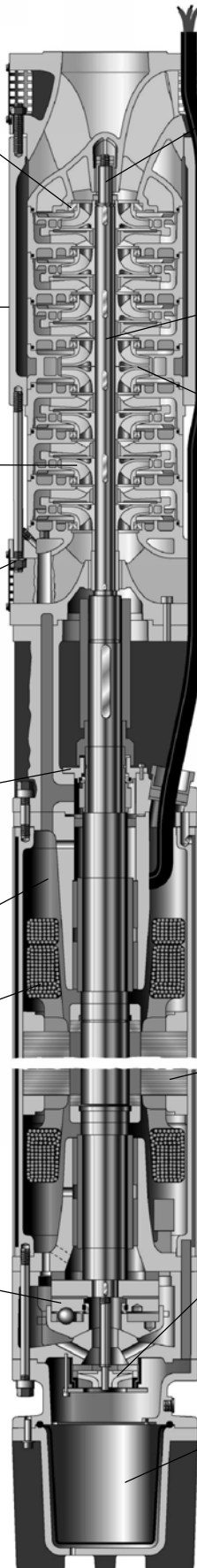

Typical Tender for S 100D

No.	Quantity	Item	Unit price Euro	Amount Euro
		<p>Submersible borehole pump(s) type S 100D for well diameters of 100 mm (4 inches) and above</p> <p>Make: KSB Pump + motor: S 100D - / + kW</p> <p>Multistage centrifugal pump for vertical / angled / horizontal ¹⁾ installation. Integrated, anti-blockage check valve with double-guided valve disc. Plain bearing lubricated by the fluid pumped and protected against ingress of sand. Discharge nozzle with threaded end.</p> <p>Submersible canned motor for 1-phase a.c. current (including starter with thermal overcurrent relay) / three-phase current ¹⁾, with self-aligning thrust bearing, expansion diaphragm for pressure equalization and cable kit / 1.5 / 2.5 ¹⁾ m power supply cable.</p> <p>Fluid pumped: clean or slightly contaminated water with a permissible sand content of up to 50 g/m³!</p> <p>Outer pump casing, suction casing and check valve housing CrNi steel Stage casing (diffuser) glass fibre reinforced NORYL Impellers glass fibre reinforced NORYL Shaft (pump) Chrome steel Bearing (pump) Rubber Motor (shaft and housing) CrNi steel</p> <p>Capacity Q = _____ m³/h / _____ l/s Head H = _____ m Temperature (fluid handled) t = _____ °C Rated power (motor) P_N = _____ kW Speed / Frequency n ≈ _____ rpm / f = _____ Hz Voltage / Starting U = _____ V / _____ d.o.l. Pump end G 1 1/4" (DN 32) / 2" (DN 50) ¹⁾ Outside diameter D_{max} = _____ mm Pump set length / weight .. L_A ≈ _____ mm / G_A ≈ _____ kg</p>		
		<p>Adapter from G1 1/4" to R1 1/2" . Adapter from threaded end G _____ to flanged end DN _____ . Pair of supporting and installation clamps for risers R1 1/4" (DN 32) / R2" (DN 50) ¹⁾. Cooling shroud with suction strainer and pedestals for horizontal installation.</p>		
		<p>Power supply cable _____ x _____ mm², separate/connected ¹⁾, length _____ m. Cable connector, separable / non-separable¹⁾, with sealing compound, motor supply cable not connected and sealed/connected and sealed¹⁾ at the factory. Cable tie UPA CONTROL box for 1 ~ / 230 V and 3 ~ / 400 V with thermal overcurrent relay with phase failure protection, temperature-compensated, insulating enclosure, with 3 electrodes and integrated "Dry running protection" / "Water level control" selector switch. Motor contactor for 1 ~ / 230 V with ON/OFF switch for automatic operation, insulating enclosure. Dry running protection equipment: - for semi-automatic operation with 2 ¹⁾ - for fully automatic operation with 3 ¹⁾ control current lines with a length of _____ m each. Lightning protection with earthing terminal for 1 ~ 230 V / 3 ~ 400 V ¹⁾. Automatic control unit Controlmatic E / Cervomatic EDP¹⁾.</p>		
			Sum total	

¹⁾ Delete as applicable

Typical Tender UPA 100C

No.	Qty	Item	Unit price	Amount
		<p>Submersible borehole pump(s) type UPA 100C for well diameters of 100 mm (4 inches) and above.</p> <p>Marke: KSB Pump + motor: UPA 100C - _____ / _____ + _____</p> <p>Multistage centrifugal pump for vertical / angled / horizontal ¹⁾ installation. Components of stainless steel with a minimum wall thickness of 1 mm and vanes welded at 6 points. Integrated check valve. Generously dimensioned plain bearing lubricated by the fluid pumped. Discharge nozzle with threaded end.</p> <p>Submersible canned motor for 1-phase a.c. current (including starter with thermal overcurrent relay) / three-phase current ¹⁾, with self-aligning thrust bearing, expansion diaphragm for pressure equalization and cable kit / 1.5 / 2.5 ¹⁾ m power supply cable.</p> <p>Fluid handled: clean or slightly contaminated water with a permissible sand content of up to 50 g/m³.</p> <p>Suction and discharge casing CrNi steel Diffusers CrNi steel Impellers CrNi steel Shaft (pump) CrNi steel Bearing (pump) Rubber Motor (shaft and housing) CrNi steel Capacity Q = _____ m³/h / _____ l/s Head H = _____ m Temperature (fluid handled) t = _____ °C Rated power (motor) P_N = _____ kW Speed / Frequency n ≈ _____ rpm/ f = _____ Hz Voltage / Starting U = _____ V/ direkt Pump end R_P 1 1/2" (DN 40) / 2" (DN 50) ¹⁾ Outside diameter D_{max} = _____ mm Pump set length / weight L_A ≈ _____ mm/G_A ≈ _____ kg</p>		
		<p>Adapter from G _____ to DN _____ . Pair of supporting and installation clamps for risers R1 1/4" (DN 32) / R2" (DN 50) ¹⁾.</p>		
		<p>Power supply cable _____ x _____ mm², separate / connected¹⁾, length _____ m Cable connector, separable / non-separable¹⁾, with sealing compound, motor supply cable not connected and sealed / connected and sealed¹⁾ at the factory. Cable tie UPA CONTROL box for 1~ / 230 V and 3~ / 400 V with thermal overcurrent relay with phase failure protection, temperature-compensated, insulating enclosure, with 3 electrodes and integrated "Dry running protection" / "Water level control" selector switch. Motor contactor for 1~ / 230 V with ON / OFF switch for automatic operation, insulating enclosure. Dry running protection equipment: - for semi-automatic operation with 2 ¹⁾ - for fully automatic operation with 3 ¹⁾ control current lines with a length of _____ m each. Lightning protection with earthing terminal for 1~ 230 V / 3~ 400 V ¹⁾.</p>		
			Sum total	

¹⁾ Delete as applicable

Typical Tender for UPA 150C

No.	Qty	Item	Unit price	Amount
		<p>Submersible borehole pump type UPA 150C for well diameters of 150 mm (6 inches) and above.</p> <p>Make: KSB Pump + motor: UPA _____ - _____ / _____ +</p> <p>Multistage centrifugal pump for vertical or horizontal installation in all-stainless steel design • intermediate bearing in every stage • stage casings connected by metal straps • integrated easy-to-remove anti-jam non-return valve • threaded or flanged pump outlet on option • suction strainer, drive lantern and valve body made of investment cast stainless steel • laser-welded impellers • drinking water approved to ACS</p> <p>Pre-filled submersible motor • three-phase current • squirrel-cage design with self-aligning thrust bearing and adequately sized expansion diaphragm for pressure equalisation • design in compliance with VDE standards • IP 68 enclosure • with power supply cable</p> <p>Fluid handled: clean to slightly contaminated water, slightly aggressive / more aggressive / as specified in water analysis¹⁾, with a permissible sand content of up to 50 g/m³.</p> <p>Suction casing CrNiMo - steel Pump shroud and body of non-return valve CrNiMo - steel Impeller, diffuser and stage casing CrNi - / CrNiMo - steel ¹⁾ Shaft (pump + motor) CrNi - / CrNiMo - steel ¹⁾ Stator case (motor) CrNi - / CrNiMo - steel ¹⁾ Bolts, screws and nuts CrNi - / CrNiMo - steel ¹⁾</p> <p>Capacity Q = _____ m³/h / _____ l/s Head H = _____ m Shut-off head H₀ = _____ m Temperature (fluid pumped) t = _____ °C Rated power / amperage P_N = _____ kW / I_N = _____ A Speed / Frequency n ≈ _____ rpm / f = _____ Hz Supply voltage U = _____ V Starting d.o.l. / star / delta ¹⁾ Pump end Internal thread G 2¹/₂" / Flange DN 50 ¹⁾ Outside diameter D_{max} = _____ mm</p>		
		<p>Pair of supporting and installation clamps for riser R / DN ¹⁾ _____.</p> <p>Set of bearing pedestals for horizontal installation (for motor UMA only)</p>		
		<p>Power supply cable, separate/connected ¹⁾, _____ mm², length _____ m.</p> <p>Cable connector, separable/non-separable¹⁾, size _____, with sealing compound, motor supply not connected and sealed / connected and sealed ¹⁾ at the factory.</p> <p>Cable tie, size _____.</p> <p>UPA CONTROL box for 1~ / 230 V and 3~ / 400 V with thermal overcurrent relay with phase failure protection, temperature-compensated, insulating enclosure, with 3 electrodes and integrated "Dry running protection" / "Water level control" selector switch.</p> <p>Dry running protection equipment - for semi-automatic operation with 2 ¹⁾ - for fully automatic operation with 3 ¹⁾ control current lines with a length of _____ m each.</p> <p>Lightning protection for three-phase current (3~) with earthing terminal.</p> <p>Temperature monitoring equipment Pt 100 for use in submersible motors to protect the windings from overheating; it consists of a resistance thermometer with measuring line and does not include / includes¹⁾ a display unit. (for motor UMA only)</p>		
			Sum total	

¹⁾ Delete as applicable

Typical Tender UPA 200B / 250C

No.	Qty	Item	Unit price	Amount
		<p>Submersible borehole pump(s) type UPA 200/200B/250C¹⁾ for well diameters of 200 mm (8 inches) and above.</p> <p>Make: KSB Pump + motor: UPA _____ - _____ / _____ + _____</p> <p>Multistage centrifugal pump in ring-section design for vertical / horizontal ¹⁾ installation. Radial or mixed-flow hydraulic systems with impellers that can be turned down. Pump bearing lubricated by the fluid pumped and protected against ingress of sand. Integrated check valve with anti-blockage, spring-loaded valve disc / connection branch. Pump end with internal thread / flange ¹⁾. Suction casing with suction strainer fitted between pump and motor.</p> <p>Pre-filled submersible motor. Three-phase current. Squirrel-cage design with self-aligning thrust bearing and adequately sized expansion diaphragm for pressure equalization. Design in compliance with VDE standards. IP 68 enclosure. With power supply cables. Required flow velocity past the motor: $v \geq 0.2$ m/s.</p> <p>Fluid handled: clean to slightly contaminated water, slightly aggressive / more aggressive / as specified in water analysis¹⁾, with a permissible sand content of up to 50 g/m³.</p> <p>Casings cast iron / bronze ¹⁾ Impellers glass fibre reinforced NORYL/ bronze ¹⁾ (UPA 200/200B) / bronze (UPA 250C) Wear rings bronze Shaft (pump + motor) Chrome / CrNiMo steel ¹⁾ Stator case (motor) CrNi / CrNiMo steel ¹⁾ Bolts, screws and nuts CrNiMo steel (A4-70) Capacity $Q =$ _____ m³/h / _____ l/s Head $H =$ _____ m Shut-off head $H_o =$ _____ m Efficiency η Pump _____ % / Motor _____ % Temperature (fluid pumped) $t =$ _____ °C Rated power / amperage $P_N =$ _____ kW / $I_N =$ _____ A Speed / Frequency $n \approx$ _____ rpm / $f =$ _____ Hz Supply voltage $U =$ _____ V Starting d.o.l. / star-delta ¹⁾ Pump end G3" (DN 80) / G5" (DN 125) / G6" (DN 150) ¹⁾ Outside diameter $D_{max} =$ _____ mm</p> <p>Economic efficiency analysis (for ex. for 10 years): Operating period per year approx. _____ h / Electricity costs _____ /kWh. Pump data tolerances to ISO 9906 Class 1. During the acceptance test, the overall efficiency may be max. 3 percentage points lower than the overall efficiency quoted ($\eta_{\text{pump}} \times \eta_{\text{motor}}$).</p>		
		<p>Adapter, from threaded end G _____ to flange DN _____ standard / special ¹⁾. Pair of supporting and installation clamps for riser R / DN ¹⁾ _____. Set of bearing pedestals for horizontal installation without / with¹⁾ water storage tank.</p>		
		<p>Power supply cable, separate/connected ¹⁾, _____ mm², length _____ m. Cable connector, size _____, with sealing compound, motor supply not connected and sealed / connected and sealed ¹⁾ at the factory. Cable tie, size _____. Dry running protection equipment - for semi-automatic operation with 2 ¹⁾ - for fully automatic operation with 3 ¹⁾ control current lines with a length of _____ m each. Temperature monitoring equipment Pt 100 for use in submersible motors to protect the windings from overheating; it consists of a resistance thermometer with measuring line and does not include / includes¹⁾ a display unit. (for motor UMA only)</p>		
			Sum total	

¹⁾ Delete as applicable

Typical Tender for UPA 300 / 350

No.	Qty	Item	Unit price	Amount
		<p>Submersible borehole pump(s) type UPA 300/350¹⁾ for well diameters of 300 mm (12 inches) and above.</p> <p>Make: KSB Pump + motor: UPA _____ - _____ / _____ +</p> <p>Multistage centrifugal pump in ring-section design for vertical / horizontal ¹⁾ installation. Mixed flow hydraulic systems with impellers that can be turned down. Pump bearing lubricated by the fluid pumped and protected against ingress of sand. Integrated check valve with anti-blockage, spring-loaded valve disc / connection branch. Pump end with internal thread / flange ¹⁾. Suction casing with suction strainer fitted between pump and motor.</p> <p>Pre-filled submersible motor. Three-phase current. Squirrel-cage design with self-aligning thrust bearing and adequately sized expansion diaphragm for pressure equalization. Design in compliance with VDE standards. IP 68 enclosure. With power supply cables. Required flow velocity past the motor: $v \geq 0.2$ m/s.</p> <p>Fluid handled: clean to slightly contaminated water, slightly aggressive / more aggressive / as specified in water analysis¹⁾, with a permissible sand content of up to 50 g/m³.</p> <p>Casings cast iron / bronze ¹⁾ Impellers bronze Wear rings bronze Shaft (pump + motor) Chrome / CrNiMo steel ¹⁾ Stator case (motor) CrNiMo steel Bolts, screws and nuts CrNiMo steel (A4)</p> <p>Capacity $Q =$ _____ m³/h / _____ l/s Head $H =$ _____ m Shut-off head $H_0 =$ _____ m Efficiency η Pump _____ % / Motor _____ % Temperature (fluid handled) $t =$ _____ °C Rated power / amperage $P_N =$ _____ kW / $I_N =$ _____ A Speed / Frequency $n \approx$ _____ rpm / $f =$ _____ Hz Supply voltage $U =$ _____ V Starting d.o.l. / star-delta ¹⁾ Pump end G6" / G8" / DN 150 / DN 200 / DN 250 ¹⁾ Outside diameter $D_{max} =$ _____ mm</p> <p>Economic efficiency analysis (for ex. for 10 years): Operating period per year approx. _____ h / Electricity costs _____ /kWh. Pump data tolerances to ISO 9906 Class 1. During the acceptance test, the overall efficiency may be max. 3 percentage points lower than the overall efficiency quoted (η "pump" x η "motor").</p>		
		<p>Pair of supporting and installation clamps for riser R / DN ¹⁾. _____ .</p> <p>Set of bearing pedestals for horizontal installation without / with¹⁾ water storage tank.</p>		
		<p>Power supply cable, separate / connected ¹⁾, _____ mm², _____ m length.</p> <p>Cable connector, size _____, with sealing compound, motor supply not connected and sealed / connected and sealed ¹⁾ at the factory.</p> <p>Cable tie, size _____ .</p> <p>Dry running protection equipment - for semi-automatic operation with 2 ¹⁾ - for fully automatic operation with 3 ¹⁾ control current lines with a length of _____ m each.</p> <p>Temperature monitoring equipment Pt 100 for use in submersible motors to protect the windings from overheating; it consists of a resistance thermometer with measuring line and does not include / includes¹⁾ a display relay.</p>		
Sum total				

¹⁾ Delete as applicable

Submersible Motors for Well Diameters of 100 mm (4 inches) and above

DN 100, UMA 150D to 300D

Sizes / Connection

DN 100, UMA 150D, UMA 200D: NEMA standard
 UMA 250D, UMA 300D: KSB standard

Material Variants (Material specifications to EN)

DN 100

		C1
All components		CrNi steel

UMA

		G	C2	C3
Shaft	150D	CrNi steel (1.4305 ⁴⁾ / 1.4021 ⁵⁾	CrNiMo steel (1.4462)	CrNiMo steel (1.4462)
	200D	CrNiMo steel (1.4462)	CrNiMo steel (1.4462)	CrNiMo steel (1.4462)
	250D		--	CrNiMo steel (1.4462)
	300D		--	CrNiMo steel (1.4462)
Housing	150D	Cast iron (JL1030) ²⁾	CrNiMo steel (1.4409)	CrNiMo steel (1.4539)
	200D		CrNiMo steel (1.4408)	CrNiMo steel (1.4539)
	250D	Cast iron (JL1040) ¹⁾	--	CrNiMo steel (1.4517)
	300D		--	CrNiMo steel (1.4517)
Stator case	150D	CrNi steel (1.4301)	CrNiMo steel (1.4571)	CrNiMo steel (1.4539)
	200D		CrNiMo steel (1.4571)	CrNiMo steel (1.4539)
	250D	CrNi steel (1.4301)	--	CrNiMo steel (1.4462)
	300D		--	CrNiMo steel (1.4462)
Screws, bolts and nuts ³⁾	150D	CrNi steel (1.4301)	CrNiMo steel (A4-70)	CrNiMo steel (1.4539)
	200D	CrNiMo steel (A4-70)	CrNiMo steel (A4-70)	
	250D	CrNiMo steel (A4-70)	CrNiMo steel (A4-70)	CrNiMo steel (1.4539)
	300D	CrNiMo steel (1.4571)	--	CrNiMo steel (1.4462)

¹⁾ DIN mat. code: GG-25 ⁴⁾ only for UMA 150D ≤ 22/21
²⁾ DIN mat. code: GG-20 ⁵⁾ only for UMA 150D > 22/21
³⁾ In contact with fluid handled

Bearings / Lubrication

Two radial plain bearings as well as a thrust bearing to balance the pump's axial thrust. Lubrication by motor fill liquid.

Direction of Rotation of the Motor

Anti-clockwise rotation (when looking at the drive shaft end).

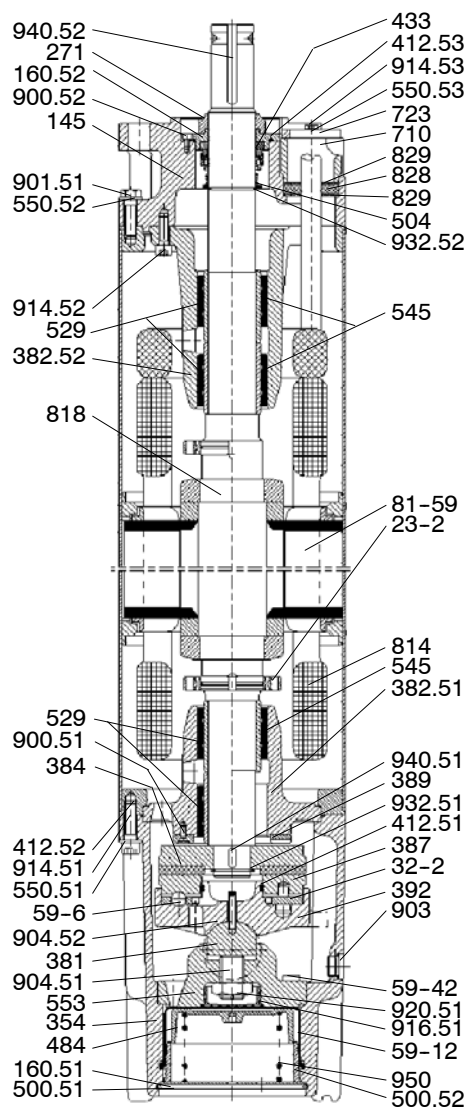

Example: UMA 250D

Variants Available on Request

- DN 100: Other supply voltages up to 500 V
- UMA 150D - 300D: Other supply voltages up to 1000 V

Part No.	Description
145	Adapter
354	Thrust bearing housing
382.51/52	Bearing carrier (bottom) / (top)
384/387	Thrust bearing plate / segment
389	Counter thrust bearing ring
433	Mechanical seal
59-12	Membrane
529/545.51	Bearing sleeve / Bearing bush
81-59	Stator with windings
818	Rotor
828/829.51	Cable grommet / Cable gland ring

Submersible Motors DN 100 , UMA 150D to 300D: 1~+ 3~, n ≈ 2900 rpm, d.o.l. + Y-Δ

Motor size	P _N kW	I _N			η _M 4/4 %	cos φ 4/4 -	Cu ∅ (submerged)		D mm	L		m	
		1~	3~				d.o.l. mm ²	Y-Δ mm ²		Standard		Standard	
		230 V A	380 V A	400 V A						1~ ≈ mm	3~ ≈ mm	1~ ≈ kg	3~ ≈ kg
DN 100 ...													
0.37	0.37	3.2	1.1	1.1	66	0.70	1 x 1.5	--	96	242	223	8.3	7.3
0.55	0.55	4.3	1.6	1.6	67	0.75	1 x 1.5	--		271	242	9.6	8.3
0.75	0.75	5.3	2.1	2.1	69	0.75	1 x 1.5	--		299	271	10.8	9.6
1.1	1.10	7.8	3.0	3.0	73	0.76	1 x 1.5	--		327	299	13.5	10.8
1.5	1.50	9.9	3.9	4.0	73	0.76	1 x 1.5	--		356	327	14.4	12.1
2.2	2.20	15.9	5.8	5.9	75	0.75	1 x 1.5	--		460	356	18.0	13.5
3.0	3.00	--	7.5	7.8	76	0.75	1 x 1.5	--		--	423	--	16.0
3.7	3.70	--	9.0	9.1	77	0.79	1 x 1.5	--		--	552	--	22.5
5.5	5.50	--	13.5	13.7	76	0.79	1 x 1.5	--	--	704	--	29.0	
UMA 150D ...													
UMA 150D 5/21	5.5	--	13.9	13.2	76	0.80	1 x 1.5	2 x 1.5	143	--	699	--	48
UMA 150D 7/21	7.5	--	18.1	17.2	77	0.82	1 x 1.5	2 x 1.5		--	719	--	50
UMA 150D 9/21	9.3	--	21.8	20.8	78	0.83	1 x 1.5	2 x 1.5		--	749	--	53
UMA 150D 13/21	13.0	--	30.1	28.6	81	0.82	1 x 4.0	2 x 1.5		--	829	--	58
UMA 150D 15/21	15.0	--	33.7	32.0	81	0.83	1 x 4.0	2 x 1.5		--	874	--	62
UMA 150D 18/21	18.5	--	42.0	39.9	82	0.82	1 x 4.0	2 x 1.5		--	919	--	67
UMA 150D 22/21	22.0	--	49.3	46.8	84	0.81	1 x 4.0	2 x 1.5		--	1009	--	76
UMA 150D 26/21	26.0	--	57.1	54.3	85	0.82	1 x 6.0	2 x 4		--	1114	--	87
UMA 150D 30/21	30.0	--	66.8	63.5	85	0.81	1 x 6.0	2 x 4		--	1214	--	97
UMA 150D 37/22	37.0	--	82.2	78.1	83	0.83	2 x 4.0 ²⁾	2 x 4		--	1294	--	101
UMA 200D ...													
UMA 200D 37/21	37	--	78.1	74.2	86	0.84	2 x 10 ²⁾	2 x 10	189	--	1140	--	130
UMA 200D 45/21	45	--	93.5	88.8	87	0.85	2 x 6 ²⁾	2 x 6		--	1230	--	145
UMA 200D 55/21	55	--	113	107	88	0.85	2 x 6 ²⁾	2 x 6		--	1340	--	165
UMA 200D 65/21	65	--	133	126	88.5	0.85	2 x 10 ²⁾	2 x 10		--	1470	--	187
UMA 200D 75/21	75	--	152	144	88.5	0.85	2 x 10 ²⁾	2 x 10		--	1560	--	203
UMA 200D 90/21	90	--	183	174	89	0.84	2 x 16 ²⁾	2 x 16		--	1740	--	235
UMA 250D ...													
UMA 250D 85/21	85	--	1) ¹⁾	162	88.8	0.85	2 x 16	2 x 16	232	--	1419	--	260
UMA 250D 110/21	110	--	1) ¹⁾	210	89.0	0.85	2 x 25 ²⁾	2 x 25		--	1529	--	295
UMA 250D 132/21	132	--	1) ¹⁾	248	90.0	0.86	2 x 25 ²⁾	2 x 25		--	1659	--	340
UMA 250D 160/21	160	--	1) ¹⁾	301	90.0	0.86	2 x 25 ³⁾	2 x 35		--	1769	--	390
UMA 250D 190/21	190	--	1) ¹⁾	361	90.2	0.84	2 x 35 ³⁾	2 x 50		--	1919	--	428
UMA 300D ...													
UMA 300D 250/22	250	--	--	466	88.4	0.88	2 x 70 ³⁾	2 x 70	282	--	2073	--	574
UMA 300D 300/22	300	--	--	558	89.2	0.87	7 x 95 ³⁾	7 x 95		--	2253	--	652
UMA 300D 400/22	400	--	--	740	89.6	0.87	7 x 95 ³⁾	7 x 95		--	2373	--	704

1) On request.

2) Δ-wiring of the 2 motor leads for d.o.l. starting in the cable connector or in the control box.

3) Parallel cable

Additional motor data:

Frequency of starts	DN 100 ≤ 20/h
.....	UMA 150D: ≤ 15/h
.....	UMA 200D/250D: ≤ 10/h
Horizontal installation	DN 100: all sizes
.....	UMA 150D: ≤ 30/21
.....	UMA 200D: ≤ 75/21
.....	UMA 250D: ≤ 160/21
.....	UMA 300D: ≤ 400/22

Motor cable:



DN 100: L = 1.5 m (≤ 1.5 kW) / 2.5 m (> 1.5 kW), 1 x
UMA 150D: L = 4 m, 1 x or 1 x + 1 x
UMA 200D: L = 6 m, 1 x + 1 x
UMA 250D: L = 6 m, 1 x + 1 x or 1 x + 1 x (≥ 35 mm ²)
UMA 300D: L = 10m, 2 x (70 mm ²) + 1 x (35 mm ²) or 6 x (95 mm ²) + 1 x (95 mm ²)
Other cables on request.

Accessories

Description		Ident. No.	≈ kg	
	Electric extension cable¹⁾, blue , rubber-sheathed cable for submerged operation in drinking water applications, ambient temperatures $t \leq +50 \text{ }^\circ\text{C}$. - Cable kit, 4-core, round, only for pump sets with three-phase current (3~) motors, DN 100, G RD GWT - J - 4G 1.5 (4 x 1.5 mm ²) with earth conductor L = 5 m Consisting of: 1 plug, 2.5 m cable, 1 cable connector size 28 and additional cable lengths.	10 m 15 m 20 m 25 m 30 m 35 m 40 m	1.55 2.45 3.35 4.25 5.15 6.05 6.95 7.85	
	- Cable kit, 4-core, round, G RD GWT - J - with earth conductor	4G 1.5 (4 x 1.5 mm ²) 4G 2.5 (4 x 2.5 mm ²) 4G 4.0 (4 x 4.0 mm ²) 4G 6.0 (4 x 6.0 mm ²) 4G 10 (4 x 10 mm ²) 4G 16 (4 x 16 mm ²) 4G 25 (4 x 25 mm ²) 4G 35 (4 x 35 mm ²) 4G 50 (4 x 50 mm ²) 4G 70 (4 x 70 mm ²)	per m	90 068 174 0.180 90 068 175 0.259 90 068 176 0.356 90 068 177 0.475 90 068 178 0.837 90 068 179 1.220 90 068 180 1.770 90 068 181 2.304 90 068 182 3.185 90 068 183 4.364
	- Cable kit, 3-core, flat, G FL GWT - O - without earth conductor	3 x 1.5 mm ² 3 x 2.5 mm ² 3 x 4.0 mm ² 3 x 6.0 mm ² 3 x 10 mm ² 3 x 16 mm ² 3 x 25 mm ² 3 x 35 mm ² 3 x 50 mm ² 3 x 70 mm ²	per m	90 068 148 0.110 90 068 149 0.171 90 068 150 0.252 90 068 151 0.319 90 068 152 0.486 90 068 153 0.750 90 068 154 1.107 90 068 155 1.438 90 068 156 2.054 90 068 157 2.760
	For selection see details and examples on pages 110 - 113			
	Shielded Hydrofirm (T) cable	S07BC4B-F 3x6/6KON		01 101 358
	Shielded Hydrofirm (T) cable	S07BC4B-F 3x16/16KON		01 101 360
	Shielded Hydrofirm (T) cable	S07BC4B-F 3x35+3G16/3		01 101 361
	Standard cable connector with heat shrink tube, non-separable.			
	- 4 x 1.5 mm ² and 4 x 2.5 mm ²			40 980 058 0.1
	- As above, but connected and sealed at the factory			40 980 708 0.1
- 4 x 4 mm ²			39 020 537 0.1	
- As above, but connected and sealed at the factory			39 020 536 0.1	
	Cable connector, separable , including sealing compound, size 25, only for pump sets with 3~ motors, DN 100, for connecting 1 extension cable to ... 1 motor lead - not including connection - including connection		90 033 494 0.6 90 039 543 0.6	
	Note: Can only be supplied together with the pump set.			
	Separately available: - Short cable: 1.5 m long, 4 x 1.5 mm ² , with plug and cable joint		00 117 947 0.4	
	2.5 m long, 4 x 1.5 mm ² , with plug and cable joint		01 025 739 0.7	
	- Cable joint: for 1 x 4 x 1.5 mm ² , flat, or up to 1 x 4 x 4 mm ² , round		00 117 792 0.2	

¹⁾ For permissible cable lengths see pages 112 and 113

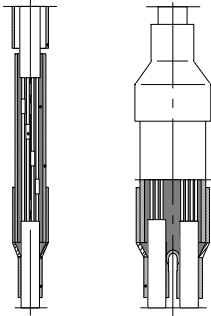
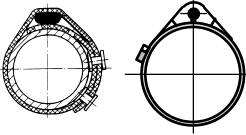
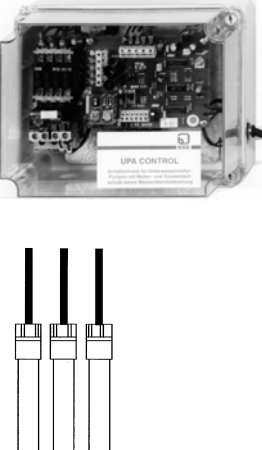

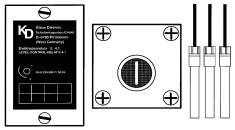
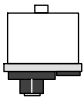
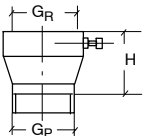
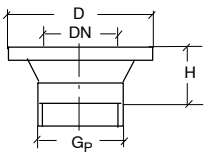
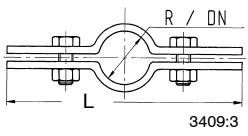

Accessories

	Description	Ident. No.	≈ kg																								
 <p>3300:236/2</p>	<p>Cable connector, non-separable, including sealing compound, for connecting 1 extension cable to 1 or 2 motor leads</p> <ul style="list-style-type: none"> - . Size 28 for connecting 1 extension cable to ... <ul style="list-style-type: none"> 1 motor lead - supplied, but not connected <li style="padding-left: 20px;">- connected and sealed at the factory - . Size 35 for connecting 1 extension cable to ... <ul style="list-style-type: none"> 1 motor lead - supplied, but not connected <li style="padding-left: 20px;">- connected and sealed at the factory - Size 43 for connecting 1 extension cable to ... <ul style="list-style-type: none"> a) 1 motor lead - supplied, but not connected <li style="padding-left: 20px;">- connected and sealed at the factory b) 2 motor lead - supplied, but not connected <li style="padding-left: 20px;">- connected and sealed at the factory <p>Sizes 53 to 78 available on request. For selection see details and examples on page 114.</p>	<p>95 005 106</p> <p>90 049 385</p> <p>90 049 397</p> <p>90 049 387</p> <p>90 049 399</p> <p>90 049 389</p> <p>90 049 400</p> <p>90 049 390</p>	<p>0.45</p> <p>0.45</p> <p>0.5</p> <p>0.5</p> <p>0.55</p> <p>0.55</p> <p>0.55</p> <p>0.55</p>																								
 <p>Size 1 Size ≥ 2</p>	<p>Cable tie for fastening power supply cable to riser</p> <ul style="list-style-type: none"> - Size 1 (rubber strap / plastic studs), for cable sizes up to 1 FL 3 x 6 mm² or 4 x 6 mm² and 1 RD 4 x 6 mm² - Sizes 2 - 11 (metal strap / screw band with tension screw / rubber cable protector), for larger cross-sections up to 70 mm² available on request <p>Note: Cable ties for pump sets of material execution G and B on request. Note: Use 1 cable tie each per cable and per 3 m of riser pipe. For selection see details and examples on page 115.</p>	<p>01 088 095</p> <p>---</p>	<p>0.04</p> <p>---</p>																								
	<p>“UPA CONTROL” box for 1~ / 230 V and 3~ / 400 V, for d.o.l. starting, temperature-compensated, insulating enclosure, with 4 PG cable glands for round cable, 3 immersion electrodes and integrated selector switch for “Dry running protection” or “Water level control” operation, as well as with thermal overcurrent relay with phase failure protection, for motor sizes ...</p> <table border="0" style="width: 100%;"> <tr> <td style="width: 50%;">1~/230 V:</td> <td style="width: 50%;">3~/400 V:</td> </tr> <tr> <td>---</td> <td>0.37 kW</td> </tr> <tr> <td>---</td> <td>0.55 kW + 0.75 kW</td> </tr> <tr> <td>---</td> <td>1.10 kW + 1.50 kW</td> </tr> <tr> <td>0.37 + 0.55 kW</td> <td>---</td> </tr> <tr> <td>0.75 kW</td> <td>2.20 kW</td> </tr> <tr> <td>1.10 kW</td> <td>3.00 kW + 3.7 kW</td> </tr> <tr> <td>1.50 kW</td> <td></td> </tr> <tr> <td>2.2 kW</td> <td>5.50 kW</td> </tr> <tr> <td>---</td> <td>7.50 kW</td> </tr> <tr> <td>---</td> <td>UMA 150D - 5/21</td> </tr> <tr> <td>---</td> <td>UMA 150D - 7/21</td> </tr> </table> <p>Plus 1 control current line, blue, 1 x 1.5 mm², for each electrode per m</p>	1~/230 V:	3~/400 V:	---	0.37 kW	---	0.55 kW + 0.75 kW	---	1.10 kW + 1.50 kW	0.37 + 0.55 kW	---	0.75 kW	2.20 kW	1.10 kW	3.00 kW + 3.7 kW	1.50 kW		2.2 kW	5.50 kW	---	7.50 kW	---	UMA 150D - 5/21	---	UMA 150D - 7/21	<p>40 980 887</p> <p>40 980 889</p> <p>40 980 891</p> <p>40 980 893</p> <p>40 980 895</p> <p>40 980 897</p> <p>40 980 899</p> <p>40 984 811</p> <p>90 052 649</p> <p>40 984 811</p> <p>90 052 649</p>	<p>3.5</p> <p>3.5</p> <p>3.5</p> <p>3.5</p> <p>3.5</p> <p>3.5</p> <p>3.5</p> <p>3.5</p> <p>3.5</p> <p>3.5</p> <p>3.5</p>
1~/230 V:	3~/400 V:																										
---	0.37 kW																										
---	0.55 kW + 0.75 kW																										
---	1.10 kW + 1.50 kW																										
0.37 + 0.55 kW	---																										
0.75 kW	2.20 kW																										
1.10 kW	3.00 kW + 3.7 kW																										
1.50 kW																											
2.2 kW	5.50 kW																										
---	7.50 kW																										
---	UMA 150D - 5/21																										
---	UMA 150D - 7/21																										
 <p>Cervomatic EDP</p> <p>Controlmatic E</p>	<p>Automatic control units Cervomatic EDP with G 1 1/4” connection, for a max. capacity of 12 m³/h, max. flow rate of 12 m³/h, a max. operating pressure of 10 bar and a max. current rating of 10 A, for 1~ + 3~/ 220 to 240 V and 3~/ 380 to 415 V (with electric protection from 0 to 10 A, can be set in 0.5 A steps).</p> <p>Controlmatic E with G 1 1/4” connection, for a max. flow rate of 10 m³/h, a max. operating pressure of 10 bar and a max. current rating of 10 A, for 1~ 220 to 240 V</p>	<p>90 053 396</p> <p>90 053 395</p>	<p>2.2</p> <p>1.3</p>																								

Accessories

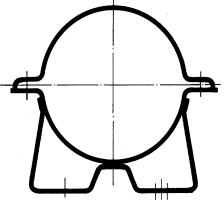
	Description	Ident. No.	≈ kg
	<p>Dry running protection equipment for ...</p> <ul style="list-style-type: none"> - semi-automatic operation (1 relay, 1 pushbutton + 2 electrodes) - fully automatic operation (1 relay + 3 electrodes) <p>Plus 1 control current line, blue, 1 x 1.5 mm², for each electrode per m</p>	<p>90 009 553 90 009 554 01 096 713</p>	<p>2.0 2.0 0.051</p>
	<p>Pressure controller, (membrane-type), insulating enclosure 1 - 10 bar, with R 3/8 connection.</p>	<p>01 088 101</p>	<p>0.9</p>
	<p>Adapter from threaded end G 1 1/4" to threaded end G 1 1/2" Material: CrNiMo steel</p> <p>Mode of supply: sealed and screwed tightly into the pump end.</p>	<p>90 052 823</p>	<p>0.50</p>
	<p>Adapter, threaded end G / Flange DN, PN 10/40 with 2 recesses on flange, 90° spacing</p> <ul style="list-style-type: none"> - G 1 1/2" / DN 40, CrNi steel (H = 120 mm, D = 155 mm) - G 2" / DN 50, CrNi steel (H = 145 mm, D = 165 mm) - G 2" / DN 50, CrNiMo steel (H = 145 mm, D = 165 mm) - G 3" / DN 80, CrNiMo steel (H = 180 mm, D = 200 mm) <p>Mode of supply: sealed and screwed tightly into the pump end. Other sizes and materials on request.</p>	<p>90 050 611 95 000 220 95 000 221 95 000 233</p>	<p>3.0 3.5 3.5 5.6</p>
	<p>Flanged end piece for UPA 150C only</p> <ul style="list-style-type: none"> - Flanged Adapter <ul style="list-style-type: none"> DN 50, PN 16 - 40 DN 65, PN 16 - 40 DN 80, PN 16 - 40 - Threated Adapter <ul style="list-style-type: none"> G3" G4" 	<p>01 116 438 01 116 439 01 116 440 01 124 645 01 124 644</p>	<p>3.28 3.64 7.00 2.50 3.00</p>
	<p>Pair of supporting and installation clamps for the following riser sizes ... incl. screws, bolts and nuts, - R 1 1/4" / DN 32, L = 600 mm, F = 11.8 kN for installation / dismantling - R 2" / DN 50, L = 600 mm, F = 17.5 kN of vertical submersible - R 2 1/2" / DN 65 L = 600 mm, F = 17.5 kN pump sets in / - R 3" / DN 80, L = 600 mm, F = 17.5 kN from wells, tanks, etc. - R 4" / DN 100 L = 700 mm, F = 24.5 kN Material: Steel, painted. - R 5" / DN 125 L = 800 mm, F = 31.0 kN - R 6" / DN 150 L = 800 mm, F = 31.0 kN - R 8" / DN 200 L = 900 mm, F = 108 kN</p> <p>Note: 2 pairs are required for installation / dismantling. Other sizes and materials on request.</p>	<p>95 000 290 95 000 294 95 000 296 95 000 298 95 000 300 95 000 302 95 000 304 95 000 307</p>	<p>7.5 11.5 12.0 12.0 21.0 29.0 29.0 70.0</p>

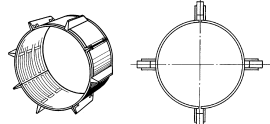
Accessories

	Description	Ident. No.	≈ kg																																																								
	<p>Set of bearing pedestals for horizontal installation consisting of 2 bearing pedestals, incl. screws, bolts and nuts. Material:</p> <table border="0"> <tr> <td>CrNi steel 1.4301</td> <td>- UPA 150C pumps with UMA 150D motors . .</td> <td>01 117 821</td> <td>1.5</td> </tr> <tr> <td>Galvanized steel</td> <td>- UPA 200 pumps with UMA 150D motors . .</td> <td>90 017 255</td> <td>2.5</td> </tr> <tr> <td>S235 JRG2+Z</td> <td>- UPA 200 pumps with UMA 200D motors . .</td> <td>01 046 640</td> <td>2.5</td> </tr> <tr> <td>CrNi steel 1.4301</td> <td>- UPA 200B pumps with UMA 150D motors . .</td> <td>01 061 866</td> <td>2.5</td> </tr> <tr> <td></td> <td>- UPA 200B pumps with UMA 200D motors . .</td> <td>01 061 867</td> <td>2.5</td> </tr> <tr> <td></td> <td>- UPA 250C pumps with UMA 150D motors . .</td> <td>01 061 868</td> <td>2.5</td> </tr> <tr> <td></td> <td>- UPA 250C pumps with UMA 200D motors . .</td> <td>01 061 869</td> <td>2.5</td> </tr> <tr> <td></td> <td>- UPA 250C pumps with UMA 250D motors . .</td> <td>01 061 870</td> <td>2.5</td> </tr> <tr> <td>Galvanized steel</td> <td>- UPA 300-65 pumps with UMA 200D motors</td> <td>01 046 644</td> <td>7.8</td> </tr> <tr> <td>S235 JRG2+Z</td> <td>- UPA 300-94 pumps with UMA 200D motors</td> <td>01 046 645</td> <td>7.8</td> </tr> <tr> <td></td> <td>- UPA 350 pumps with UMA 200D motors . .</td> <td>01 046 646</td> <td>8.0</td> </tr> <tr> <td></td> <td>- UPA 300-65 pumps with UMA 250D motors</td> <td>01 053 905</td> <td>16.0</td> </tr> <tr> <td></td> <td>- UPA 300-94 pumps with UMA 250D motors</td> <td>01 053 906</td> <td>16.0</td> </tr> <tr> <td></td> <td>- UPA 350 pumps with UMA 250D motors . .</td> <td>01 053 907</td> <td>17.2</td> </tr> </table> <p>Note: Screws, bolts and nuts for fixing the bearing pedestals on the foundation are to be supplied by the customer / end user. Other sizes and materials on request.</p>	CrNi steel 1.4301	- UPA 150C pumps with UMA 150D motors . .	01 117 821	1.5	Galvanized steel	- UPA 200 pumps with UMA 150D motors . .	90 017 255	2.5	S235 JRG2+Z	- UPA 200 pumps with UMA 200D motors . .	01 046 640	2.5	CrNi steel 1.4301	- UPA 200B pumps with UMA 150D motors . .	01 061 866	2.5		- UPA 200B pumps with UMA 200D motors . .	01 061 867	2.5		- UPA 250C pumps with UMA 150D motors . .	01 061 868	2.5		- UPA 250C pumps with UMA 200D motors . .	01 061 869	2.5		- UPA 250C pumps with UMA 250D motors . .	01 061 870	2.5	Galvanized steel	- UPA 300-65 pumps with UMA 200D motors	01 046 644	7.8	S235 JRG2+Z	- UPA 300-94 pumps with UMA 200D motors	01 046 645	7.8		- UPA 350 pumps with UMA 200D motors . .	01 046 646	8.0		- UPA 300-65 pumps with UMA 250D motors	01 053 905	16.0		- UPA 300-94 pumps with UMA 250D motors	01 053 906	16.0		- UPA 350 pumps with UMA 250D motors . .	01 053 907	17.2		
CrNi steel 1.4301	- UPA 150C pumps with UMA 150D motors . .	01 117 821	1.5																																																								
Galvanized steel	- UPA 200 pumps with UMA 150D motors . .	90 017 255	2.5																																																								
S235 JRG2+Z	- UPA 200 pumps with UMA 200D motors . .	01 046 640	2.5																																																								
CrNi steel 1.4301	- UPA 200B pumps with UMA 150D motors . .	01 061 866	2.5																																																								
	- UPA 200B pumps with UMA 200D motors . .	01 061 867	2.5																																																								
	- UPA 250C pumps with UMA 150D motors . .	01 061 868	2.5																																																								
	- UPA 250C pumps with UMA 200D motors . .	01 061 869	2.5																																																								
	- UPA 250C pumps with UMA 250D motors . .	01 061 870	2.5																																																								
Galvanized steel	- UPA 300-65 pumps with UMA 200D motors	01 046 644	7.8																																																								
S235 JRG2+Z	- UPA 300-94 pumps with UMA 200D motors	01 046 645	7.8																																																								
	- UPA 350 pumps with UMA 200D motors . .	01 046 646	8.0																																																								
	- UPA 300-65 pumps with UMA 250D motors	01 053 905	16.0																																																								
	- UPA 300-94 pumps with UMA 250D motors	01 053 906	16.0																																																								
	- UPA 350 pumps with UMA 250D motors . .	01 053 907	17.2																																																								
	<p>Pt 100 temperature monitoring equipment for use in submersible motors to protect the windings from overheating. Consisting of</p> <table border="0"> <tr> <td>- Resistance thermometer</td> <td>---</td> <td>---</td> </tr> <tr> <td>- Control current line, blue, round 4 x 0.5 mm² per m</td> <td>01 103 205</td> <td>0.085</td> </tr> <tr> <td>- Display / control box (supply voltage U = 110/220V)</td> <td>90 064 446</td> <td>0.320</td> </tr> </table> <p>Note: Motor with Pt 100 are manufactured to order.</p>	- Resistance thermometer	---	---	- Control current line, blue, round 4 x 0.5 mm ² per m	01 103 205	0.085	- Display / control box (supply voltage U = 110/220V)	90 064 446	0.320																																																	
- Resistance thermometer	---	---																																																									
- Control current line, blue, round 4 x 0.5 mm ² per m	01 103 205	0.085																																																									
- Display / control box (supply voltage U = 110/220V)	90 064 446	0.320																																																									
	<p>Centralizer for submersible motors for UMA 150D and UMA 200D motors in wells up to DN 350, plastic (PE)</p> <table border="0"> <tr> <td>bis DN 250</td> <td>90 047 662</td> <td>---</td> </tr> <tr> <td>bis DN 300</td> <td>90 047 663</td> <td>---</td> </tr> <tr> <td>bis DN 350</td> <td>90 047 664</td> <td>---</td> </tr> </table> <p>Other sizes and materials on request.</p>	bis DN 250	90 047 662	---	bis DN 300	90 047 663	---	bis DN 350	90 047 664	---																																																	
bis DN 250	90 047 662	---																																																									
bis DN 300	90 047 663	---																																																									
bis DN 350	90 047 664	---																																																									
	<p>Cooling, suction and pressure shroud for vertical and horizontal installation, Galvanized steel and CrNiMo steel material variants on request.</p>																																																										
	<p>Stainless steel immersion electrodes</p> <table border="0"> <tr> <td>3 electrodes</td> <td>40 980 055</td> <td>0.3</td> </tr> <tr> <td>1 electrode</td> <td>40 980 056</td> <td>0.1</td> </tr> </table>	3 electrodes	40 980 055	0.3	1 electrode	40 980 056	0.1																																																				
3 electrodes	40 980 055	0.3																																																									
1 electrode	40 980 056	0.1																																																									
	<p>Stainless steel wire rope for S 100D</p> <table border="0"> <tr> <td>15 m</td> <td>42 200 727</td> <td>0.7</td> </tr> <tr> <td>30 m</td> <td>42 204 021</td> <td>1.2</td> </tr> </table>	15 m	42 200 727	0.7	30 m	42 204 021	1.2																																																				
15 m	42 200 727	0.7																																																									
30 m	42 204 021	1.2																																																									
	<p>Lightning protection with earthing terminal for</p> <table border="0"> <tr> <td>- 1~/ 230 V (fitted in soft starter of DN 100 motor)</td> <td>00 533 291</td> <td>0.20</td> </tr> <tr> <td>- 3~/ 400 V (supplied separately)</td> <td>00 533 299</td> <td>0.28</td> </tr> <tr> <td>cable tie per unit</td> <td>40 980 709</td> <td>--</td> </tr> </table>	- 1~/ 230 V (fitted in soft starter of DN 100 motor)	00 533 291	0.20	- 3~/ 400 V (supplied separately)	00 533 299	0.28	cable tie per unit	40 980 709	--																																																	
- 1~/ 230 V (fitted in soft starter of DN 100 motor)	00 533 291	0.20																																																									
- 3~/ 400 V (supplied separately)	00 533 299	0.28																																																									
cable tie per unit	40 980 709	--																																																									

Electric Cable for Use in Drinking Water Applications

Applications

For use in water as submersible motor lead (3- + 4-core, flat) and for use in air as extension cable from motor lead to control box / mains (3-core, flat and 4-core, round).

Application Limits

Rated voltage:

- $U_N \leq 1000$ V for ex. in wells,
- $U_N \leq 750$ V in swimming pools.

Ambient temperature $t \leq +50$ °C.

Immersion depth ≤ 500 m.

Description / Design

a) Flat cables:

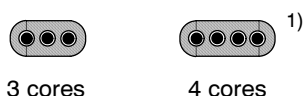

b) Round cables:

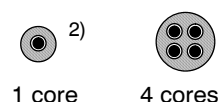

¹⁾ As a standard, for use as motor lead only.

²⁾ For use as earth conductor only.

3-/4-core rubber-sheathed cable. Consisting of finely stranded bare copper conductors, core insulation and outer sheath made of special rubber compound on EPR basis (ethylene propylene rubber), blue. With BAM ¹⁾ certificate, i.e. suitable for permanent use in drinking water applications.

¹⁾ German Federal Institute for Materials Research

Designation (Example)

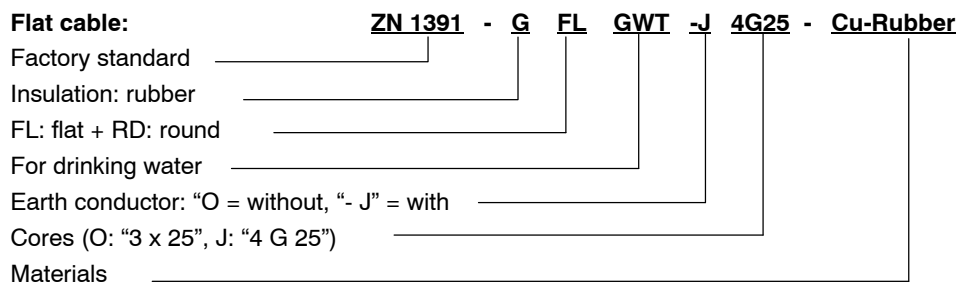

Dimensions + Weights

Type		Cross-section q in mm^2									
		1.5	2.5	4	6	10	16	25	35	50	70
	\updownarrow mm	5.2 + 1	6.1 + 1.5	7.0 + 2	7.6 + 2.2	9.3 + 2.2	11.2 + 2.3	13.0 + 2.5	14.6 + 2.9	17.0 + 3	19.3 + 2.7
	\leftrightarrow mm	11.0 + 2	13.2 + 2.3	15.5 + 3.5	17.4 + 3.6	21.5 + 3.5	26.7 + 4.3	31.6 + 3.9	35.5 + 5	42.1 + 4.9	48.4 + 3.6
	m kg/m	0.110	0.171	0.252	0.319	0.486	0.750	1.107	1.438	2.054	2.760
	\updownarrow mm	5.2 + 1	6.1 + 1.5	7.0 + 2	7.6 + 2.2	9.3 + 2.2	11.2 + 2.3	13.0 + 2.5	---	---	---
	\leftrightarrow mm	14.5 + 2.7	17.5 + 2.5	21.0 + 2.5	23.5 + 3	29.0 + 3.5	35.0 + 2.4	41.5 + 4.5	---	---	---
	m kg/m	0.165	0.237	0.339	0.440	0.704	1.026	1.457	---	---	---
	\varnothing mm	5.3 + 1.1	---	---	---	---	---	---	13.8 + 3.6	16 + 3.8	---
	m kg/m	0.051	---	---	---	---	---	---	0.499	0.699	---
	\varnothing mm	10.0 + 2	12.0 + 1.9	13.9 + 2	15.7 + 2.1	21.1 + 2.1	24.5 + 4.3	29.7 + 4.3	33.3 + 5.5	39.0 + 5.6	44.2 + 5.8
	m kg/m	0.180	0.259	0.356	0.475	0.837	1.220	1.770	2.304	3.185	4.364

Maximum Permissible Rated Motor Current I_{max}

a) Ambient temperature $t \leq + 30\text{ °C}$!

Starting	Used as ...	I_{max} in A for cross-section of ... mm ²									
		1.5	2.5	4	6	10	16	25	35	50	70
D.o.I. (1 cable or 2 cables in parallel 1))	Motor lead 2)	29	38	52	67	94	125	166	205	256	316
	Extension cable 3)	23	30	41	53	74	99	131	162	202	250
Y-Δ (2 cables)	Motor lead 2)	50	66	90	116	163	217	288	355	443	547
	Extension cable 3)	40	52	71	92	128	171	227	280	350	433

1) For 2 cables II: $I_N \leq 2 \times I_{max}$.

2) I_{max} for submerged use, laid in free water or closely along the pump. For other conditions see DIN VDE 0298.

3) I_{max} for use in open air, laid along a surface. For other conditions see DIN VDE 0298.

b) Ambient temperature $t > + 30\text{ °C}$!

If $t > + 30\text{ °C}$, the current-carrying capacity of the cables is lower. I_{max} indicated under a) must be de-rated by a factor f_T :

		t in °C			
		≤ 35	≤ 40	≤ 45	≤ 50
f_T	[--]	0.96	0.91	0.87	0.82

Voltage Drop ΔU Along Extension Cable

When calculating the required copper conductor cross-section q , not only I_N , but also the voltage drop ΔU along the cable length L (distance from motor to control box) must be taken into account. Proper functioning of our submersible motors requires that $\Delta U \leq 3\%$ of the supply voltage U !

If $\Delta U > 3\%$, a larger cable must be used.

The voltage drop is calculated using the following equations:

a) D.o.I. starting / autotransformer ...

- 1 cable:

$$3 \sim \dots \quad \Delta U = \frac{3.1 \times L \times I_N \times \cos \phi}{q \times U} \quad [\%]$$

$$1 \sim \dots \quad \Delta U = \frac{3.6 \times L \times I_N \times \cos \phi}{q \times U} \quad [\%]$$

- 2 cables in parallel (II):

$$3 \sim \dots \quad \Delta U = \frac{1.55 \times L \times I_N \times \cos \phi}{q \times U} \quad [\%]$$

$$1 \sim \dots \quad \Delta U = \frac{1.8 \times L \times I_N \times \cos \phi}{q \times U} \quad [\%]$$

b) Y-Δ starting (2 cables) ...

$$\Delta U = \frac{2.1 \times L \times I_N \times \cos \phi}{q \times U} \quad [\%]$$

Power Loss ΔP Along the Extension Cable

$$\Delta P = \frac{\Delta U}{(\cos \phi)^2} \quad [\%]$$

where ...

L = single cable length [m]

I_N = rated current [A]

$\cos \phi$ = power factor at 4/4 load

q = copper conductor cross-section [mm²]

U = supply voltage [V]

Permissible Cable Lengths L
D.O.L. Starting

(1 cable or 2 cables in parallel)

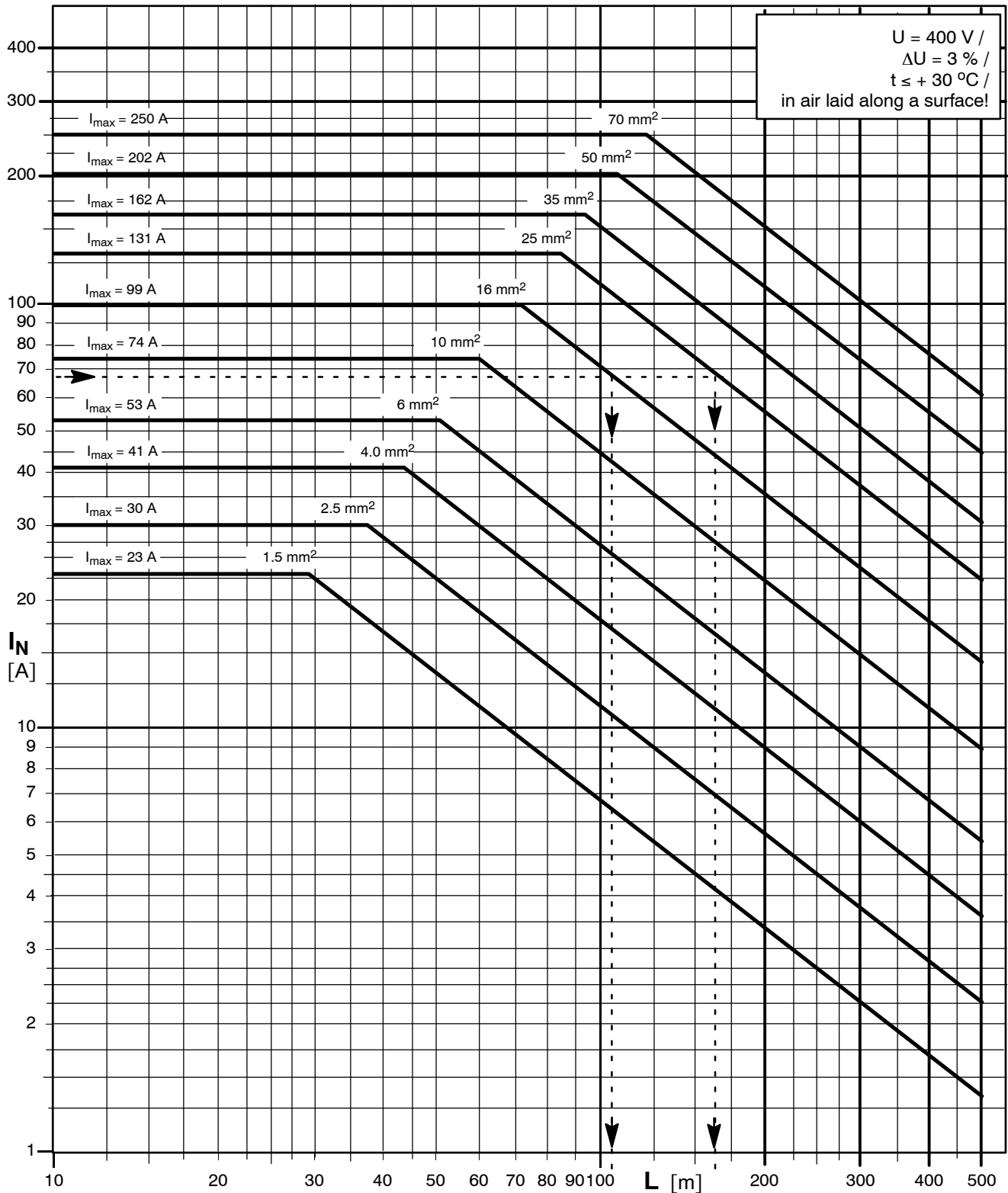

Example:

a) $I_N = 68 \text{ A}$, $1 \times 16 \text{ mm}^2$, $\Delta U \leq 3 \%$ → $L \leq 105 \text{ m}$!
 I_N = motor current resulting from actual voltage

b) $I_N = 68 \text{ A}$, $1 \times 25 \text{ mm}^2$, $\Delta U \leq 3 \%$ → $L \leq 165 \text{ m}$!

For supply voltages other than 400 V, the cable lengths must be calculated as follows, for ex. ...

$$U_1 = 400 \text{ V}, L_1 = 105 \text{ m}, U_2 = 500 \text{ V} \rightarrow L_2 = (U_2 : U_1) \times L_1, L_2 = (500 \text{ V} : 400 \text{ V}) \times 105 \text{ m} = 131.3 \text{ m}$$

For **parallel cables** the value is doubled to obtain the permissible length.

Permissible Cable Lengths L
Y-Δ Starting

(2 cables)

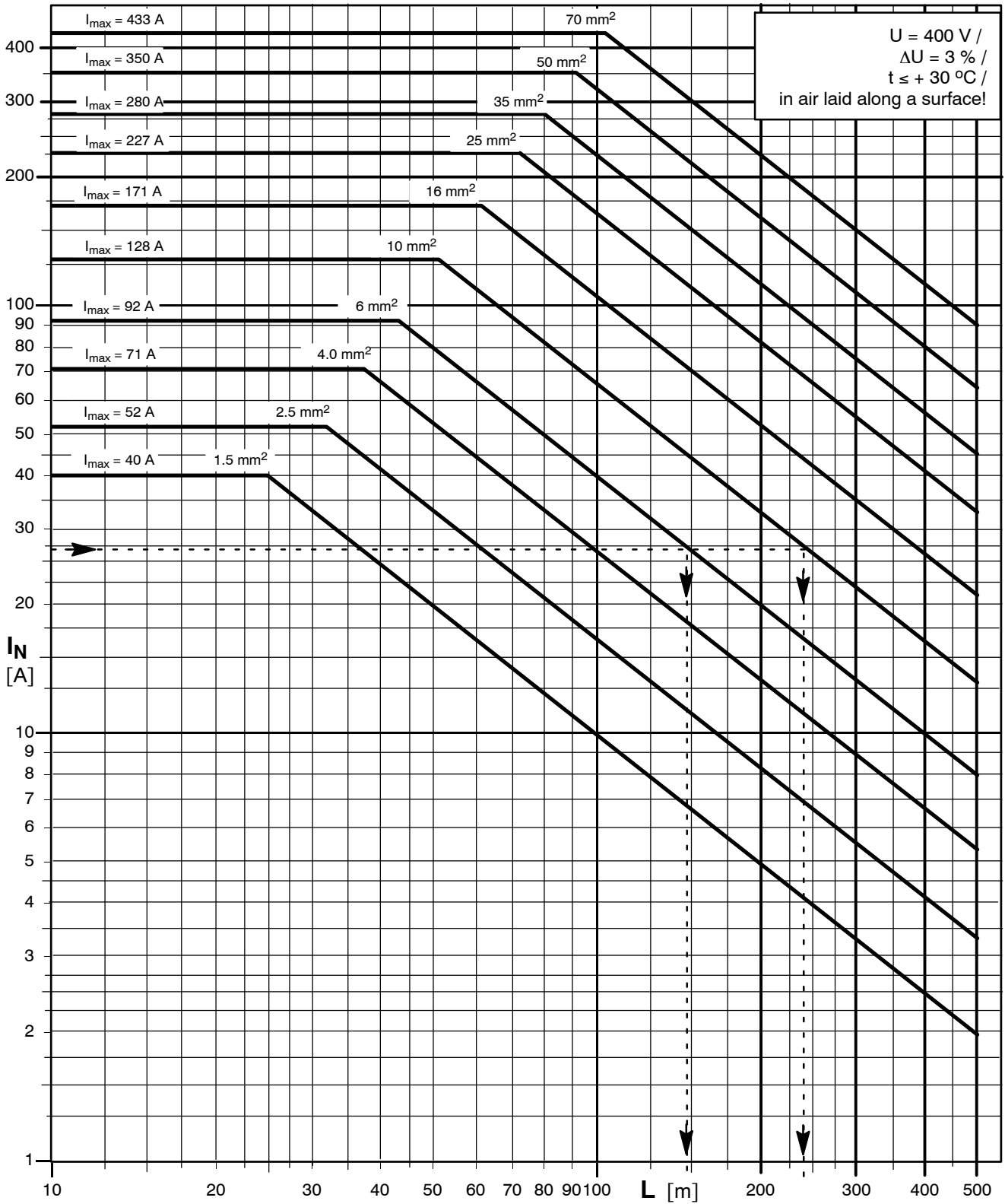

Example:

a) $I_N = 27 \text{ A}$, $2 \times 6 \text{ mm}^2$, $\Delta U \leq 3 \%$ → $L \leq 145 \text{ m}$
 I_N = motor current resulting from actual voltage

b) $I_N = 27 \text{ A}$, $2 \times 10 \text{ mm}^2$, $\Delta U \leq 3 \%$ → $L \leq 235 \text{ m}$!

For supply voltages other than 400 V, the cable lengths must be calculated as follows, for ex. ...

$$U_1 = 400 \text{ V}, L_1 = 145 \text{ m}, U_2 = 500 \text{ V}, \rightarrow L_2 = (U_2 : U_1) \times L_1, L_2 = (500 \text{ V} : 400 \text{ V}) \times 145 \text{ m} = 181.3 \text{ m}!$$

Connector for Electric Cable

Applications

Used to provide a sealed, water-tight connection between electric extension cable and submersible motor lead.

Supply voltage U ≤ 750 V.

Ambient temperature t ≤ +50 °C.

Immersion depth ≤ 500 m.

Selection Criteria

Type, number and dimensions of the motor lead and the extension cable.

Selection Table

The table below only shows the electric cables **on stock**. Connectors for other cables on request.

Motor lead mm ²	Extension cable ... mm ²									
	1.5	2.5	4	6	10	16	25	35	50	70
1.5 / 2.5	28	28	28	35	35	43	53	53	--	--
4	--	35	35	35	35	43	53	53	--	--
6	--	--	35	35	35	43/29 f	53/29 f	53/39 f	--	--
10	--	--	--	43	43/29 f	43/29 f	53/29 f	53/39 f	--	--
16	--	--	--	--	--	53	53	53	66	66
25	--	--	--	--	--	--	66	66	66	66
35	--	--	--	--	--	--	--	66	66	66
50	--	--	--	--	--	--	--	66	66	66
70	--	--	--	--	--	--	--	--	--	66
	1)									
1.5 / 2.5	28	28	28	35	35	43	53	53	--	--
4	--	35	35	35	35	43	53	53	--	--
6	--	--	35	35	35	43	53	53	--	--
10	--	--	--	43	43	43	53	53	--	--
16	--	--	--	--	--	53	53	53	66	66
25	--	--	--	--	--	--	66	66	66	66
or	1)									
1.5	28	28	28	35	35	--	--	--	--	--
2.5	35	35	35	35	35	--	--	--	--	--
4	--	--	35	35	35	43	--	--	--	--
6	--	--	--	43	43	43	53	53	66	66
10	--	--	--	66	66	66	66	66	66	66
16	--	--	--	--	--	66	66	66	66	66
25	--	--	--	--	--	--	78	78	78	--
	1)									
1.5 / 2.5 / 4	28	28	28	28	35	43	--	--	--	--
6	28	28	28	28	35	43	53	53	--	--
10	--	--	35	35	35	43	53	53	--	--
16	--	--	--	--	43	43	53	53	66	66
25	--	--	--	--	--	53	53	53	66	78
35	--	--	--	--	--	--	--	53	66	78
50	--	--	--	--	--	--	--	--	66	78
70	--	--	--	--	--	--	--	--	--	78
2)	2)									
35	--	--	--	--	--	--	--	35	--	--
50	--	--	--	--	--	--	--	--	35	--
70	--	--	--	--	--	--	--	--	--	35

1) On stock up to 50 mm² only.

2) For use as earth conductor only.

Legend: = G FL GWT -O 3 x ...

= G RD GWT -O 1 G (earth conductor for UMA 300D)

= G FL GWT -J 4G ...

= G RD GWT -J 4G

Cable Tie for Electric Cable

Applications

Securing electric cable at the riser / discharge pipe. Suitable for use in normal or slightly aggressive water. Models for use in more aggressive water (for ex. seawater) available on request.

Selection Criteria

Type, number and size of the electric cable, as well as nominal diameter and length of the riser / discharge pipe.

Selection Table

Electric cable		Tie size		Required length of strap L per cable tie in ≈ ... mm for risers G .../DN ...															
Type	Number x core dia. in mm ²		--	m ¹⁾ = kg	1 1/4"/ 32	1 1/2"/ 40	2"/ 50	.../ 65	3"/ 80	4"/ 100	5"/ 125	6"/ 150	.../ 175	8"/ 200	250	300	350	400	
Flat	3 x 1.5 to 3 x 6.0	4 x 1.5 to 4 x 6.0	1	--	270	280	320	360	400	450	500	600	----	----	----	----	----	----	
	3 x 10 to 3 x 70	4 x 10 to 4 x 70	11	0.01	--	--	350	400	450	550	650	800	950	1100	1300	1500	1700	1900	
Round	3 x 1.5 to 3 x 6.0	4 x 1.5 to 4 x 6.0	1	--	270	280	320	360	400	450	500	600	---	---	---	---	---	---	
	3 x 10	4 x 10	2	0.08	--	--	350	400	450	550	650	800	950	1100	1300	1500	1700	1900	
	3 x 16 3 x 25	4 x 16	3a	0.19	---	---	350	400	450	550	650	800	950	1100	1300	1500	1700	1900	
	3 x 35 3 x 50	4 x 25 4 x 35	3	0.19	---	---	---	450	500	600	700	850	1000	1150	1350	1550	1750	1950	
	3 x 70	4 x 50	3b	0.19	---	---	---	450	500	600	700	850	1000	1150	1350	1550	1750	1950	
	3 x 95	4 x 70 4 x 95	4	0.55	---	---	---	---	---	650	750	900	1050	1200	1400	1600	1800	2000	
	3 cables 1 x 50			7	0.6	---	---	---	---	---	700	800	950	1100	1250	1450	1650	1850	2050
	3 cables 1 x 70			8	0.6	---	---	---	---	---	700	800	950	1100	1250	1450	1650	1850	2050
	3 cables 1 x 95			6	0.6	---	---	---	---	---	700	800	950	1100	1250	1450	1650	1850	2050
	3 cables 1 x 120 3 cables 1 x 150			9	0.6	---	---	---	---	---	700	800	950	1100	1250	1450	1650	1850	2050

¹⁾ Cable protector (Sizes 11, 2 to 9).

Design

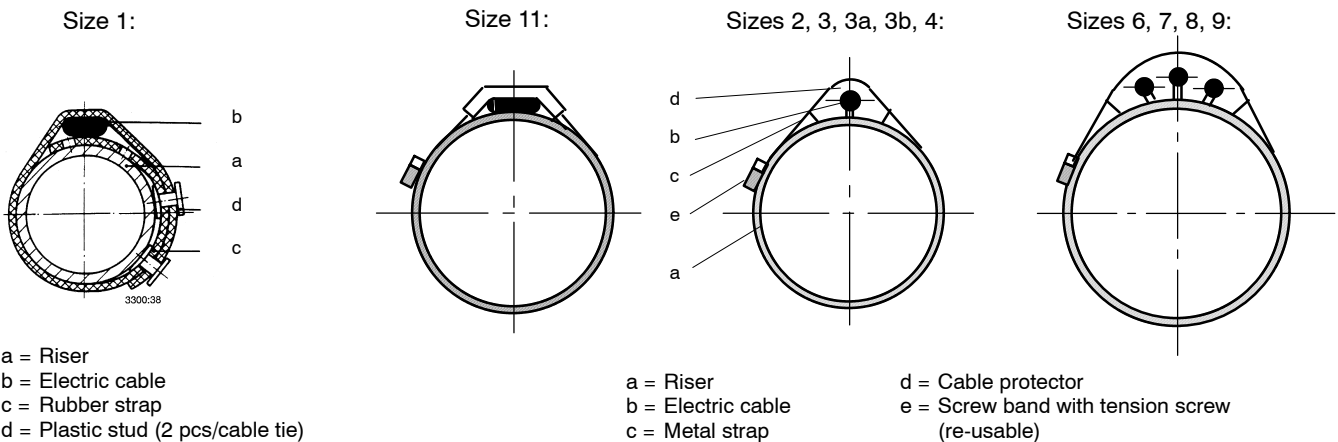

Note:

- Use 1 cable tie each per cable and per 3 m of riser pipe.
- If an extension cable with a larger diameter is connected to the motor lead, the cable tie size required for the larger cable is to be used along the entire cable length.

Flow Velocity v Past the UMA Submersible Motor

Depending on the general installation arrangement (i.e. depending, for example, on the ratio of outside motor diameter to inside well or shroud diameter, etc.) a distinction must be made between the following cases ...

a) $v = 0$ m/s ... this applies, for example, when the pump set is installed in a deep well below the well screen / filter, in a pump sump, tank or other reservoir, etc.

Caution: At $v = 0$ m/s, UMA 250D motors can only be operated at reduced rated power.

b) $v \geq 0.2$ m/s ... this describes with adequate accuracy the case when the pump set is, for example, installed in a deep well above the well screen / filter, etc. In borderline cases (for ex. if the inside well diameter is very large compared with the outside motor diameter) the diagram below can be used to double-check the data.

c) $v \geq 0.5$ m/s ... In this case it must always be checked, using the diagram below, whether the installation dimensions (i.e. the ratio of outside motor diameter to inside well diameter) are adequate to ensure a minimum flow velocity past the motor of $v \geq 0.5$ m/s. If not, use a special cooling shroud.

How to read the diagram:

The requirement for a "flow velocity past the motor of $v \geq 0.2$ or 0.5 m/s" is met, if the point of intersection of the capacity Q and the inside well or shroud diameter DN is located on or to the right of the curve applicable to the submersible motor used.

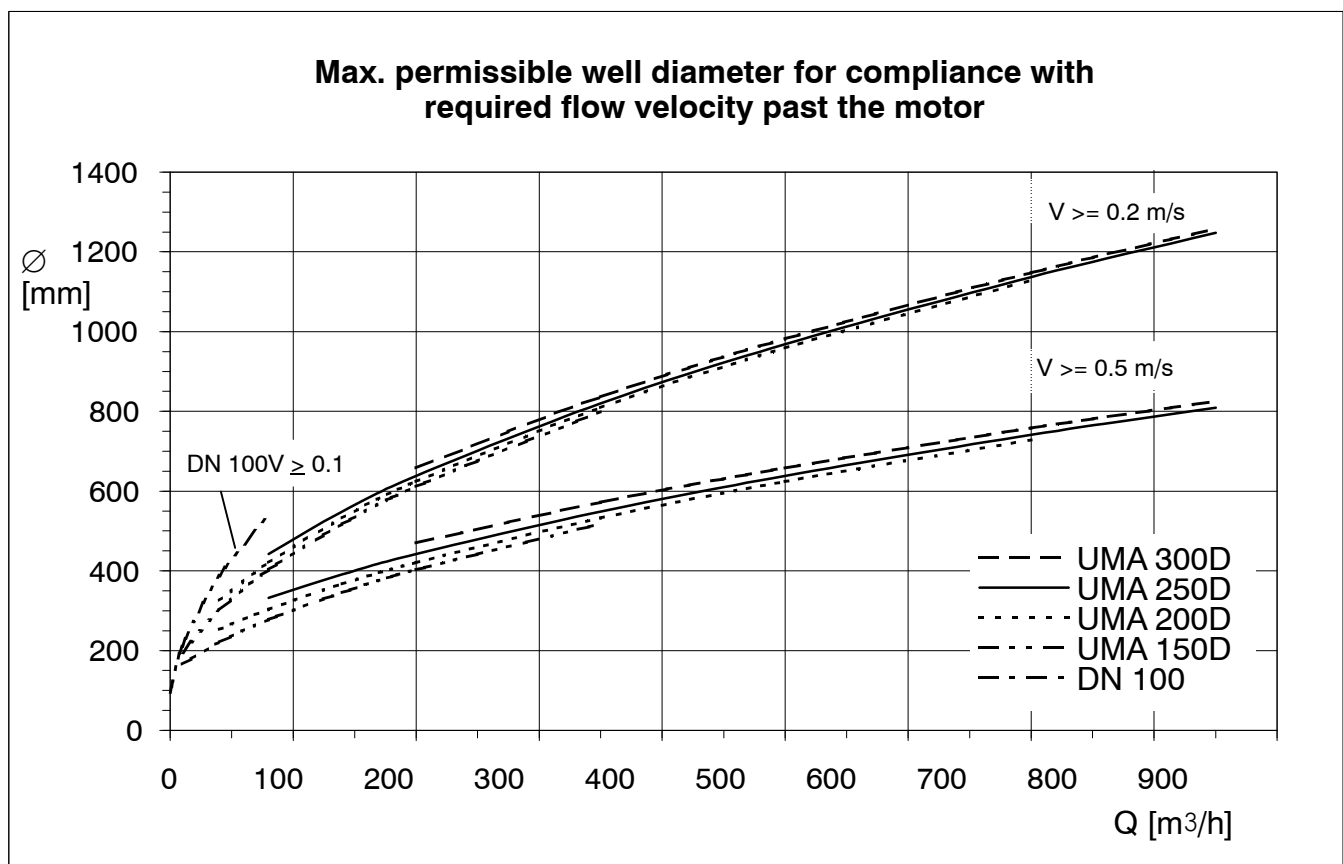

Example:

Given: UPA 300 - 65/4 + UMA 250D 160/21 and $v \geq 0.2$ m/s.

Found: For $Q = 250$ m³/h ($\approx Q_{opt}$) the following applies: $\Rightarrow DN \leq 700$ mm.

This means that the requirement for $v \geq 0.2$ m/s is met, if the pump set is, for example, installed in a well or cooling shroud of $DN \leq 700$ mm or ≤ 28 inches.

